

EGS61Z- MSR12- EGS12Z- MS



10

**CABLE-BOUND SHADING SYSTEMS AND
ROLLER SHUTTER CONTROL - THE MODULAR
APPROACH FOR THE ELECTRICAL TRADE.**

Cable-bound shading systems and roller shutter control

Shading systems and roller shutter control	16 - 2
Multi sensor MS, rain sensor RS, light sensor LS and wind sensor WS	16 - 3
Multifunction sensor relay MSR12-UC	16 - 4
Digital settable sensor relay LRW12D-UC	16 - 5
Impulse group switch EGS12Z-UC for central control	16 - 6
Impulse group switch EGS12Z2-UC for central control	16 - 7
Motor isolating relay MTR12-UC and DC motor relay DCM12-UC	16 - 7
Impulse group switch EGS61Z-230V for central control	16 - 8
Motor isolating relay MTR61-230V	16 - 9
Technical data shading systems and roller shutter control	16 - 10
Typical circuit example of a shading system control	16 - 11
Typical circuit example of a roller shutter control and shading system control	16 - 12
Typical circuit examples of a roller shutter control	16 - 13

THE MODULAR APPROACH FOR THE ELECTRICAL TRADE

Planning and realisation of a shading system or roller shutter control are classical tasks for the electrical installer.

Eltako has developed a well thought-out modular system of control devices and switchgear for mounting in switch cabinets and distribution boards.

The modular approach has been chosen to provide a control or switch-gear device (module) for any desired function match the overall system, typically permitting an individual awning to be controlled as perfectly as a large system which comprises dozens of shutters, awnings, Venetian blinds, etc.

Any assignment of control devices to the switchgear devices can be chosen, and provision is made for easy modifications, retrofitting and expansion, "bit by bit".

There are four groups of devices:

1. Sensors

Sensors serve to detect the actual situation. A light sensor, for example, measures brightness and generates a control voltage as a function of it.

2. Sensor relays

Sensor relays serve to convert the sensor-produced actual signals to control signals as a function of practical set points, whilst logic operations are performed and faulty sensors detected.

3. Actuators

Actuators serve to control the motors of shading systems and roller shutters. These are group impulse switches in hybrid technology with central control functions and possibly motor isolating relays or DC motor relays.

4. Accessories

Switching power supply units for the power supply of the multi sensor and the multifunction sensor relay as well as for the heating of the rain sensors are available as accessories.

Sensors, page 16-3	Sensor relays, page 16-4 and 16-5	Actuators, page 16-6 to 16-9
Multi sensor MS	Multifunction sensor relay MSR12-UC for brightness, twilight, wind, rain and frost	Group impulse switch EGS12Z-UC
Rain sensor RS	Light-twilight-rain-wind sensor relay LRW12D for light, twilight and wind	Group impulse switch EGS12Z2-UC
Light sensor LS		Group impulse switch EGS61Z
Wind sensor WS		Motor isolating relay MTR12-UC and MTR61
		DC motor relay DCM12-UC

The principle of overall control is quite simple: each shading element or its motor is controlled by an actuator that receives commands via sensors and, where fitted, sensor relays.

A complete Control System consists (as the smallest unit) of a switch or momentary contact switch controlled EGS12Z-UC group impulse switch for one motor. The largest unit comprises any number of sensors and sensor relays as well as any number of impulse group switches EGS12Z-UC and EGS12Z2-UC with or without motor isolating relay MTR12 and DC motor relay DCM12-UC to control the motors.



MS

Multi sensor

The MS multi sensor sends the current weather details, including brightness (from three points of the compass), wind, rain and frost, to the multifunction sensor relay MSR12-UC connected in series once per second. A standard telephone wire is sufficient as connecting lead: J-Y(ST)Y 2x2x0.8 or equivalent. 100 m line length is permitted. Solid plastic housing, l x w x h = 118x96x77 mm. Protection degree IP44. Temperature at mounting location -30°C to +50°C. A power supply unit SNT12-230V/24V DC (chapter 17) is required for the power supply, including heating of the rain sensor. This is only 1 module = 18 mm wide and it also it supplies the multifunction sensor relay MSR12-UC (page 16-4). Several MSR12-UC can be connected to a multisensor MS, e.g. for evaluating up to three directions with the light sensor of the MS.

MS	Multi sensor	EAN 4010312901731	251,50 €/pc.
----	--------------	-------------------	--------------



RS

Rain sensor

The rain sensor RS reports rain to the sensor relay LRW12D connected in series once per second. A standard telephone wire is sufficient as connecting lead: J-Y(ST)Y 2x2x0.8 or equivalent. 100 m line length is permitted. Solid plastic housing, l x w x h = 118x96x77 mm. Protection degree IP44. Temperature at mounting location -30°C to +50°C. A power supply unit SNT61-230V/24V DC or SNT12-230V/24V DC (chapter 17) is required for the power supply, including heating of the rain sensor (1.2 W). An LED lights up green when the supply voltage is applied and lights up yellow for rain.

RS	Rain sensor	EAN 4010312206546	116,40 €/pc.
----	-------------	-------------------	--------------



LS

Light sensor

The LS light sensor generates a voltage dependent on light intensity by means of a photo resistor. This voltage is evaluated in a LRW12D universal sensor relay connected in series. Solid plastic housing, l x w x h = 38x28x95 mm, Protection degree IP54. Temperature at mounting location -20°C to +60°C. Mounting with the supplied screw and nut on the accompanying aluminum mounting bracket or directly on the plastic mounting bracket KM1 of the wind sensor WS. Maximum diameter of the measuring cable (not included in the scope of supply) 5 mm.

LS	Light sensor	EAN 4010312901267	29,70 €/pc.
----	--------------	-------------------	-------------



WS

Wind sensor

The WS wind sensor provides a sequence of pulses as a function of the wind vane speed. This pulse sequence is evaluated in a LRW12D universal sensor relay connected in series. Solid plastic housing, 125 mm dia. x117 mm high. Protection degree IP54. Temperature at mounting location -15°C to +60°C. For mounting, use KM1 plastic mounting bracket that comes with the device. With 5-metre measuring lead connected.

WS	Wind sensor	EAN 4010312901281	63,60 €/pc.
----	-------------	-------------------	-------------

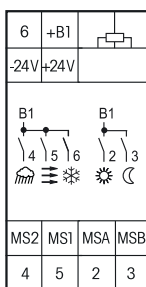

MSR12-UC



Multifunction sensor relay for brightness, twilight, wind, rain and frost, 5 OptoMOS semiconductor outputs 50 mA/8..230 V UC. Standby loss without Multi sensor MS 0.5 watt only.

Modular device for DIN 60715 TH35 rail mounting. 2 modules = 36 mm wide, 58 mm deep. The multi-sensor relay MSR12-UC evaluates the signals from the multisensor MS once per second, and sends appropriate control signals to the downstream EGS12Z-UC or EGS12Z2-UC actuators depending on the setting of the rotary switch on the front.

The OptoMOS semiconductor outputs switch the voltage applied to the universal voltage input terminal +B1. Only a single Multisensor MS can be connected to a Multifunction sensor relay MSR12-UC. Several MSR12-UC can be connected to a multisensor MS, e.g. for evaluating up to three directions with the light sensor of the MS. Only a single MSR12-UC must provide the outer terminal resistance. It must be removed if there is a further MSR12-UC. Supply voltage 24 V DC from power unit SNT12-230V/24V DC (chapter 17). This power unit simultaneously supplies the multisensor MS connected to the terminals MS1, MS2, MSA and MSB, including heating of the rain sensor surface. After installation wait for the short automatic synchronisation of approx. 1 minute. During this process three LEDs flash in a slow sequence.

Function rotary switches

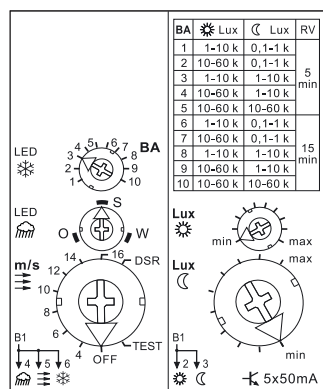

Standard setting ex works.

Function rotary switches

BA = Setting the operating modes 1 to 10 from the adjacent table. 2 delay times RV - for wind and twilight - each in connection with 5 brightness ranges for light and twilight. The LED behind the rotary switch indicates Frost when the outdoor temperature drops below 2°C, at which point output 6 closes. This output opens again as soon as the temperature is over 3°C for 5 minutes.

O-S-W = If the Multisensor MS is aligned towards the south, the weighting for light and twilight can be shifted towards the east or west. If the MS is mounted in a different direction, the desired point of the compass can be set using this rotary switch. An LED behind the rotary switch indicates **rain detection**, at which point output 4 closes. Once the rain sensor surface dries out - assisted by a heating unit - contact 4 opens immediately. This is automatically followed by a 2-second pulse on output 2 if the sun signal is applied at that moment.

m/s = This rotary switch is used to select the wind speed in metres per second at which the **wind signal** is triggered. This closes output 5. This is indicated by the LED behind the rotary switch. Opening takes place after the set delay time RV, during which the LED flashes. This is automatically followed by a 2-second pulse on output 2 if the sun signal is applied at that moment.

DSR = In this position of the wind rotary switch the MSR12-UC functions like a twilight sensor relay. The twilight signal as described under **Lux ☾** is then continuously applied to output 3 as long as the set twilight value is undershot. Output 3 opens with a delay of 5 minutes if the brightness value set is overshoot. The outputs 4 (rain) and 6 (frost) remain active as described there. Output 5 (wind) likewise remain active, but the wind signal is triggered at 10 m/s.

TEST = As long as TEST remains switched on, each switchover from the OFF position to the TEST position activates the outputs 2 to 6 in ascending order.

OFF = In the OFF position the MSR12-UC has no function.

Lux ☾ = This rotary switch is used to set the brightness at which the sun signal is immediately triggered as a 2-second pulse at output 2. The LED behind the rotary switch indicates when the brightness value is exceeded.

Lux ☽ = This rotary switch is used to set the brightness at which the 2-second twilight signal is triggered at output 3 after the set delay time RV when the value is undershot. This is indicated by the LED behind the rotary switch. It flashes during the delay time. If the twilight switching threshold is set to the same level or higher than the sun switching threshold, then the sun switching threshold is raised internally above the twilight switching threshold.

Changing light compensation: Constant changes between sun and rain clouds would result in sensitive closing and opening of the shade elements. This is prevented by a changing light compensation function.

Sensor function and open circuit monitoring: The Multisensor MS sends updated information to the MSR12-UC every second. If this signal is missing completely for 5 seconds, or if the individual signal from the wind sensor is missing for 24 hours, then an alarm is triggered: three LEDs flash rapidly and the wind output 5 is closed for 2 seconds in order to protect any awnings or windows which may be connected here. This pulse is repeated every hour. The alarm is turned off automatically when a signal is detected again.

Technical data page 16-10.
Typical connections page 16-11.
Housing for operating instructions GBA14, see accessoires, chapter Z.

MSR12-UC	5 OptoMOS	EAN 4010312205327	94,50 €/pc.
-----------------	-----------	-------------------	--------------------



+B1	-A2
LS	GND WS
Field 1	
Field 2	
Field 3	
5	4 RS
2	3

LRW12D-UC



**Light-twilight rain wind sensor relay, 4 OptoMOS semiconductor outputs 50 mA/8..230 V UC.
Standby loss 0.05-0.5 watt only.**

Modular device for DIN 60715 TH35 rail mounting. 1 module = 18 mm wide, 58 mm deep.
Supply voltage 8 to 230 V UC.

The sensor relay LRW12D evaluates the signals from the light sensor LS, the rain sensor RS and the wind sensor WS and sends appropriate control signals to the downstream EGS12Z-UC or EGS12Z-UC actuators depending on the setting via the display on the front panel.

The OptoMOS semiconductor outputs switch the voltage applied to the universal voltage input terminal +B1. A light sensor LS, rain sensor RS and wind sensor WS can be connected to a sensor relay LRW12D.

However, only one per sensor.

If one or two of the three possible sensors are not connected, OFF has to be selected in the function menu for the relevant sensor.

However, at a wind sensor WS several LRW12D can be connected for controlling different wind speeds. Then the LRW12D must be connected to the same potential +B1/-A2.

When the supply voltage UC (8-253 V AC or 10-230 V DC) is applied to B1/A2, the LRW12D can be set as described in the operating instructions.

Technical data page 16-10.
Typical connections page 16-12.
Housing for operating instructions GBA14,
see accessoires, chapter Z.

LRW12D-UC	4 OptoMOS	EAN 4010312206553	68,60 €/pc.
------------------	-----------	-------------------	--------------------

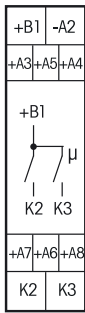

EGS12Z-UC



Impulse group switch for central control, 1+1 NO contacts not potential free 16 A/250 V AC, for 1 motor or motor relays. Standby loss 0.05-0.4 watt only.

Modular device for DIN 60715 TH35 rail mounting. 1 module = 18 mm wide, 58 mm deep.

This impulse group switch serves to implement commands generated by the sensor relays or by switches and push-buttons and controls a motor, a motor isolating relay MTR12-UC or a DC motor relay DCM12-UC dependent on the setting of the rotary switch on the front. 8 to 230V UC supply voltage and switching voltage at terminals +B1/-A2. The control voltage at terminals A3 up to A8 must have an identical potential.

The function of this electronic group impulse switch is based on the principle that, on the one hand, impulse control is used to obtain UP-Stop-DOWN-Stop (contact 1 closed - both contacts open - contact 2 closed - both contacts open) and, on the other hand, additional control inputs can be used to select UP or DOWN as desired. **Dynamic** refers to control inputs for which one impulse of not less than 20 milliseconds is sufficient to close a contact. **Static** denotes a control input for which the contact is only closed as long as the control command is applied. UP and DOWN apply to roller shutters, Venetian blinds and roller blinds. For awnings, 'UP' = retract and 'DOWN' = extend. For windows 'UP' = open and 'DOWN' = close.

Function rotary switches

AUTO 1 = When the lower rotary switch is in this position, the local advanced automatic reversing system for Venetian blinds is activated. When a push-button connected to A3+A4 (connected with a bridge) or A5/A6 connected to a dual push-button are used for local control a double impulse activates a slow rotation in the opposite direction, which can be stopped with a further impulse.

AUTO 2 = When the lower rotary switch is in this position, the local advanced automatic reversing system for Venetian blinds is completely switched off.

AUTO 3 = When the lower rotary switch is in this position, the local advanced automatic reversing system for Venetian blinds is switched off as well. The central control inputs A5 and A6 though, which are dynamic at AUTO 1 and AUTO 2, **are static at first, thus, allow reversal of Venetian blinds by operating pushbuttons.**

They only switch to dynamic after 1 second continuous operation.

▲▼ = ▲ (UP) and ▼ (DOWN) of the lower rotary switch are the positions for **manual control**. Manual control has priority over all other control commands.

WA = Automatic reversal for Venetian blinds and awnings is controlled by means of the middle rotary switch. 0 = OFF, otherwise from 0.1 to 5 seconds ON with selected reversal time. In this case, it is only for DOWN that the direction is reversed on time-out of the time lag selected by means of the top rotary switch, e.g. to extend awnings or set Venetian blinds to a defined position.

RV = The time delay (delay time RV) is set by means of the top rotary switch. If, the group impulse switch is in the UP or DOWN position the selected delay time runs (elapses); at time-out the device changes automatically to STOP. Therefore, the time delay must be chosen at least as long as the shading element or roller shutter will need to move from one limit position to the other. The LED indication for the delay times WA and RV is located behind this rotary switch.

Local control with pushbutton connected to terminals A3+A4 (to be connected with a bridge). Each impulse causes the group impulse switch to change its position in the UP-Stop-DOWN-Stop sequence.

Local control with roller shutter toggle switch connected to terminals A3 and A4.

Local control with dual roller shutter pushbutton connected to A5 and A6. The 'UP' or 'DOWN' position is activated with an impulse by pushbutton. A further impulse from one of the two push-buttons stops the sequence immediately.

Central control dynamic without priority connected to terminals A5 (UP) and A6 (DOWN). Up or DOWN is activated by a control signal. A further control signal (<700ms) at this control input interrupts this process immediately, a further control signal (>700ms) continues the process. **This is without priority** because the local input A3+A4 (with bridge) and the central control inputs A7 and A8 can immediately override even whilst the control contact on A5 or A6 is still closed.

Central control dynamic with priority connected to terminals A7 (UP) and A8 (DOWN). **With priority** because these control inputs cannot be overridden by other control inputs **as long as** the central control contact is closed. Otherwise it has the same function as the central control dynamic without priority. These central control inputs A7 and A8 are used for the sensor relays MSR12 and LRW12D for the wind sensor, the frost sensor and the rain sensor functions as these are required to have absolute priority over other sensor commands.

Function rotary switches

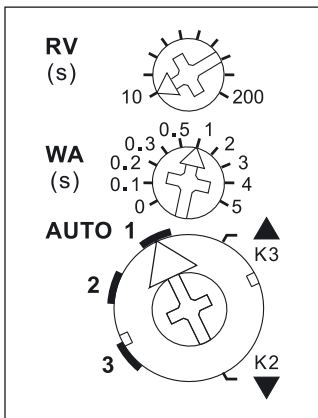

Standard setting ex works.

Technical data page 16-10.
Housing for operating instructions GBA14,
see accessories, chapter Z.

EGS12Z-UC	1 + 1 NO contacts 16 A	EAN 4010312107737	64,60 €/pc.
-----------	------------------------	-------------------	-------------

**IMPULSE GROUP SWITCH EGS12Z2-UC FOR CENTRAL CONTROL,
MOTOR ISOLATING RELAY MTR12-UC AND DC MOTOR RELAY DCM12-UC**

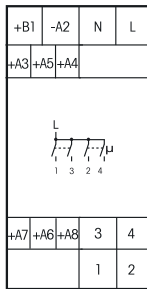

EGS12Z2-UC



Impulse group switch for central control, 2+2 NO contacts not potential free 5 A/250 V AC, for two 230 V-motors. Standby loss 0.05-0.9 watt only.

Modular device for DIN 60715 TH35 rail mounting. 2 modules = 36 mm wide, 58 mm deep.
Supply voltage 8..230 V UC at terminals +B1/-A2. The control voltage at terminals A3 up to A8 must have an identical potential. This impulse group switch serves to implement commands generated by the sensor relays or by switches and pushbuttons and controls two 230 V motors according to the setting of the rotary switches on the front. 1/2 = motor 1, 3/4 = motor 2.

The mode of operation corresponds completely to the impulse group switch EGS12Z-UC on page 16-6 in which a MTR12-UC as described below is integrated.

EGS12Z2-UC	2 + 2 NO contacts 5 A	EAN 4010312108031	87,40 €/pc.
-------------------	-----------------------	-------------------	--------------------

Technical data page 16-10.
Typical connections page 16-12.
Housing for operating instructions GBA14,
see accessoires, chapter Z.



MTR12-UC



Motor isolating relay, 2+2 NO contacts not potential free 5 A/250 V AC for one or two 230 V-motors. Standby loss 0.5 watt only.

Modular device for DIN 60715 TH35 rail mounting. 1 module = 18 mm wide, 58 mm deep.
Universal control voltage 8..230 V UC. 230 V supply voltage.
The tube-mounted motors of shading elements and roller shutters must not be connected in parallel, or reverse voltages will occur through the limit switches, ultimately causing failure of the motors.
For one motor and if the control voltage and the motor voltage are 230 V, one EGS12Z-UC is adequate. Where more than one motor is controlled by an EGS12Z-UC or in case the control voltage is different, one MTR12-UC must be connected to two motors. It must be remembered that the MTR12-UC devices, while they can be operated in parallel, require unassigned contact outputs K2/K3 of the controlling EGS12Z-UC. These have to be connected to terminals K2/K3 of the MTR12-UC. 1/2 = motor 1, 3/4 = motor 2.
The functions UP and DOWN may be blocked or switched off entirely by a rotary switch. This block applies only to the max. 2 connected motors. Therefore single shading elements or roller shutters can be completely or partially excepted from the automatic function of an over-all control.

Function rotary switch

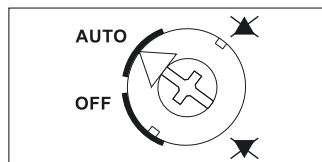

MTR12-UC and DCM12-UC

Technical data page 16-10.
Housing for operating instructions GBA14,
see accessoires, chapter Z.

MTR12-UC	2 + 2 NO contacts 5 A	EAN 4010312205211	62,50 €/pc.
-----------------	-----------------------	-------------------	--------------------

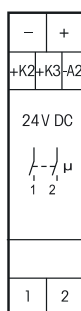

DCM12-UC



DC motor relay, 2 NO contacts not potential free 24 V DC/90 watt, for one 24 V DC motor. Standby loss 0.07 watt only.

Modular device for DIN 60715 TH35 rail mounting. 1 module = 18 mm wide, 58 mm deep.
Universal control voltage 8..230 V UC. 24 V DC supply voltage.
The DCM12-UC can be operated in parallel, but they require unassigned contact outputs K2/K3 of the controlling EGS12Z-UC. These have to be connected to terminals K2/ K3 of the DCM12-UC.
The functions UP and DOWN may be blocked or switched off entirely by a rotary switch. This block applies only to the 1 connected motor. Therefore single shading elements or roller shutters can be completely or partially excepted from the automatic function of an over-all control.

Technical data page 16-10.
Housing for operating instructions GBA14,
see accessoires, chapter Z.

DCM12-UC	2 NO contacts 90 W	EAN 4010312205310	60,80 €/pc.
-----------------	--------------------	-------------------	--------------------

IMPULSE GROUP SWITCH EGS61Z-230V FOR CENTRAL CONTROL

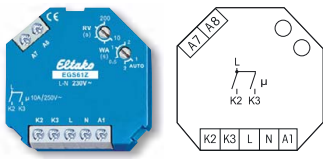

EGS61Z-230V



Impulse group switch for central control, 1+1 NO contacts not potential free 10 A/250 V AC, for one 230 V AC motor. Standby loss 0.4 watt only.

Function rotary switches

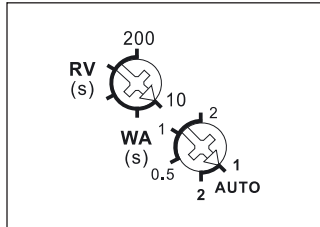

Standard setting ex factory.

Typical connection UT

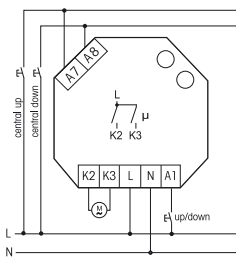

Typical connection RT

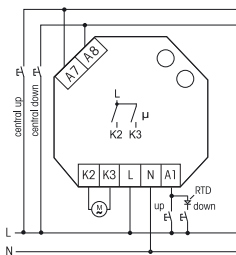

Technical data page 16-10.

For installation. 45 mm long, 45 mm wide, **32 mm deep.**

State-of-the-art hybrid technology combines advantages of nonwearing electronic control with high capacity of special relays.

This impulse group switch serves to implement commands generated by the sensor relays or by switches and push-buttons and controls a 230 V motor for a shading element or a roller shutter.

Control, supply and switching voltage 230 V.

The same control voltage must be supplied to A1, A7 and A8 as to L.

By using bistable relays coil power loss and heating is avoided even in the on mode.

The switched consumer may not be connected to the mains before the short automatic synchronisation after installation has terminated.

A universal pushbutton connected to control input A1 controls the pulse signals for 'up, stop, down, stop'. As of production week 25/18, a direction pushbutton for 'down' can be connected via the diode RTD (any polarity). Another direction pushbutton for 'up' is connected directly to A1. On the first control pulse 'down', EGS61Z switches over the control input A1 to 'direction pushbutton'. To switch the control input back to 'universal pushbutton', briefly switch off the power supply and switch back on. Additional control inputs A7 and A8 can be used for central control UP or DOWN with priority.

With priority because these control inputs cannot be overridden by other control inputs **as long as** the central control contact is closed. Up or DOWN is activated by a control signal. A further control signal (< 700 ms) at this control input interrupts this process immediately, a further control signal (> 700 ms) continues the process.

The time delay (delay time RV) is set by means of the rotary switch **RV**. If, the group impulse switch is in the UP or DOWN position the selected delay time runs (elapses); at time-out the device changes automatically to STOP. Therefore, the time delay must be chosen at least as long as the shading element or roller shutter will need to move from one limit position to the other.

With the rotary switch **WA** automatic reversal is controlled: in the setting from 0.5 to 2 sec. reversal time the automatic reversal is activated. In this case, it is only for DOWN that the direction is reversed on time-out of the time lag selected by means of the top rotary switch RV, e.g. to extend awnings or set Venetian blinds to a defined position.

AUTO 1: No automatic reversal and no local advanced automatic reversing system.

A7 and A8 operation < 1s → static process (contact closes only during operation)

operation > 1s → dynamic process (contact remains closed), stop command by new operation.

AUTO 2: Automatic reversal with 1s reversal time. Additionally the local advanced automatic reversing system for Venetian blinds at A1 is active: a double impulse activates a slow rotation in the opposite direction, which can be stopped with a further impulse.

RTD	Direction pushbutton diode	EAN 4010312908273	2,20 €/pc.
EGS61Z-230V	1+1 NO contacts 10 A	EAN 4010312108123	59,50 €/pc.

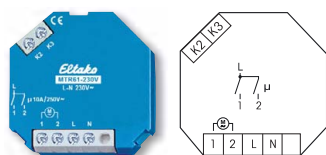

MTR61-230V



Motor isolating relay, 1+1 NO contacts not potential free 10 A/250 V AC, for one 230 V AC motor. Standby loss 0.4 watt only.

For installation. 45 mm long, 55 mm wide, **32 mm deep.**

State-of-the-art hybrid technology combines advantages of nonwearing electronic control with high capacity of special relays.

This actuator implements the instructions of the EGS61Z and switches a 230 V motor for a shading element or a roller shutter at 1-2. Therefore connect the motor connections K2-K3 of the EGS61Z with the K2-K3 connections of one or several MTR61.

Control, supply and switching voltage 230 V.

Technical data page 16-10.

MTR61-230V	1 + 1 NO contacts 10 A	EAN 4010312206577	56,20 €/pc.
-------------------	------------------------	-------------------	--------------------

TECHNICAL DATA SHADING SYSTEMS AND ROLLER SHUTTER CONTROL

Type	EGS12Z ^{b)}	EGS12Z2 ^{b)}	EGS61Z ^{b)} MTR61 ^{b)}	LRW12D/MSR12 ¹⁾	MTR12/DCM12
Contacts					
Contact material/contact gap	AgSnO ₂ /0.5 mm	AgSnO ₂ /0.5 mm	AgSnO ₂ /0.5 mm	OptoMOS	AgSnO ₂ /0.5 mm
Spacing of control connections/contact	3 mm	3 mm	3 mm	3 mm/6 mm	3 mm
Test voltage as per VDE 0110 control connection/contact	2000 V	2000 V	2000 V	LRW12D: 2000 V MSR12: 4000 V	2000 V
Rated switching capacity	16 A/250 V AC	5 A/250 V AC	10 A/250 V AC	50mA/8..230 V UC	5 A/250 V AC DCM: 90 W
Inductive load cos φ = 0.6/230 V AC inrush current ≤ 35 A	650 W	650 W ²⁾	650 W	-	MTR12: 650 W ²⁾
Life at rated load, cos φ = 0.6	>4x10 ⁴	>4x10 ⁴	>4x10 ⁴	-	>4x10 ⁴
Switch position indication	WA and RV	WA and RV	-	LRW12D: Display MSR12: LED	LED
Maximum conductor cross-section (3-fold terminal)	6 mm ² (4 mm ²)	6 mm ² (4 mm ²)	4 mm ²	6 mm ² (4 mm ²)	6 mm ² (4 mm ²)
Two conductors of same cross-section (3-fold terminal)	2.5 mm ² (1.5 mm ²)	2.5 mm ² (1.5 mm ²)	1.5 mm ²	2.5 mm ² (1.5 mm ²)	2.5 mm ² (1.5 mm ²)
Screw head	slotted /cross-head, pozidriv	slotted /cross-head, pozidriv	slotted /cross-head	slotted /crosshead, pozidriv	slotted /cross-head, pozidriv
Type of enclosure/terminals	IP50/IP20	IP50/IP20	IP30/IP20	IP50/IP20	IP50/IP20
Electronics					
Time on (also for central on/off)	100%	100%	100%	100%	100%
Max./min. temperature at mounting location	+50°C/-20°C	+50°C/-20°C	+50°C/-20°C	+50°C/-20°C	+50°C/-20°C
Standby loss (active power) at 230 V	0.4 W	0.9 W	0.4 W	LRW12D: 0.5 W MSR12: -	MTR12: 0.5 W
Standby loss (active power) at 24 V	0.1 W	0.1 W	-	LRW12D: 0.1 W MSR12: 0.5 W	DCM12: 0.07 W
Standby loss (active power) at 12 V	0.05 W	0.05 W	-	LRW12D: 0.05 W MSR12: -	-
Control current A1 or A3-A8 at 12/24/230 V ±20%	0.05/0.11/0.7 mA	0.05/0.11/0.7 mA	-/-/0.7 mA	-	0.1/0.2/1 mA
Max. parallel capacitance (approx. length) of control lead at 230 V AC	0.06 μF (200 m)	0.06 μF (200 m)	0.3 μF (1000 m) MTR61: 0.06 μF (200 m)	-	0.3 μF (1000 m)
Min. command duration	50 ms	50 ms	50 ms	-	-

^{b)} Bistable relay as relay contact. Do not connect the switched consumer to the mains before the short automatic synchronisation after installation has terminated.

¹⁾ After installation and after a power failure the multisensor needs approx. 1 minute before the wind sensor is active. During this process the outputs wind and sun of the MSR12-UC are blocked and 3 LEDs flash slowly.

²⁾ Inductive load cos φ = 0.6 as sum of both contacts 1000 W max.

If necessary, see the operating instructions of the appropriate shading elements for the maximum wind speed that can be set for the sensor relays.

m/s	4	6	8	10	12	14	16
km/h	14.4	21.6	28.8	36.0	43.2	50.4	57.6
Bft	3	4	4	5	6	7	7

Do not route measurement leads parallel to other electrical lines - measurement leads must be screened statically if longer than 10m. For example JY-ST-Y. To extend leads use screw terminals and damp-proof connectors.

When selecting an installation site for light, wind and multi sensors, ensure that the sensors are not in the shadow of the objects being monitored.

To comply with DIN VDE 0100-443 and DIN VDE 0100-534, a Type 2 or Type 3 surge protection device (SPD) must be installed.

WITH MULTIFUNCTION SENSOR RELAY MSR12-UC

For clarity, the L and N connections are not shown.
 Similarly, provision made for local control through A3 and A4 are not shown.

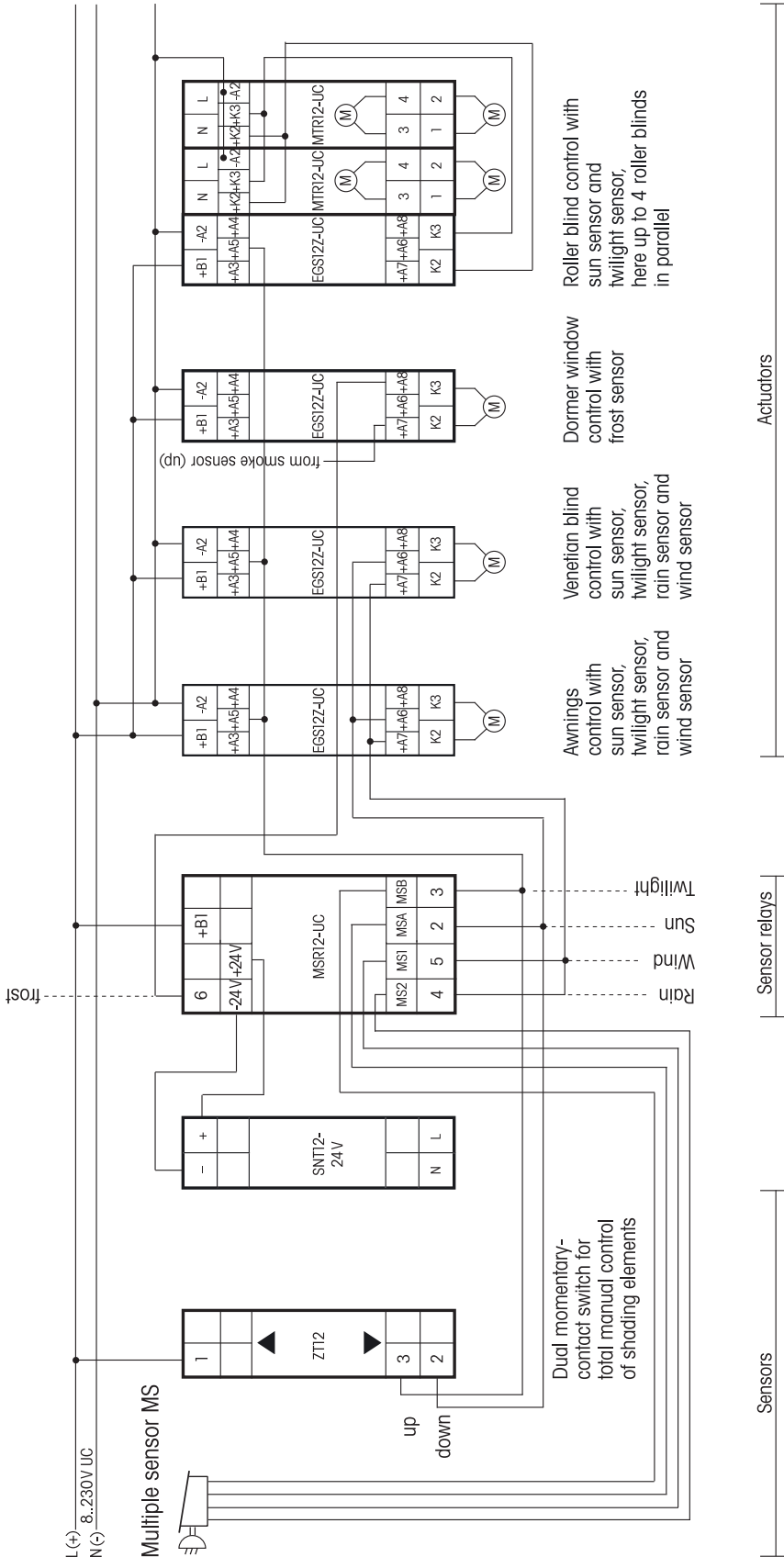

When controlling with 230 V (+B1=L, -A2=N) the 230 V motors are directly connected to K2, K3 and N. Otherwise motor isolating relays MTR12-UC must be interconnected to K2/K3. A night time window can be set with a digital time switch with 1 CO so that the multi sensor does not cause any disturbance. To do this, program the changeover as follows: in the daytime the terminal +B1 of MSR12-UC connect to L(+) and at night time L(+) direct to terminal 3 of MSR12-UC. This simulates twilight at the beginning of the time window in order to open all shading elements and at the same time all sensors are switched off.

TYPICAL CIRCUIT EXAMPLE OF A ROLLER SHUTTER CONTROL AND SHADING SYSTEM CONTROL

SHADING SYSTEM WITH THE LIGHT, TWILIGHT, RAIN AND WIND SENSOR RELAY LRW12D

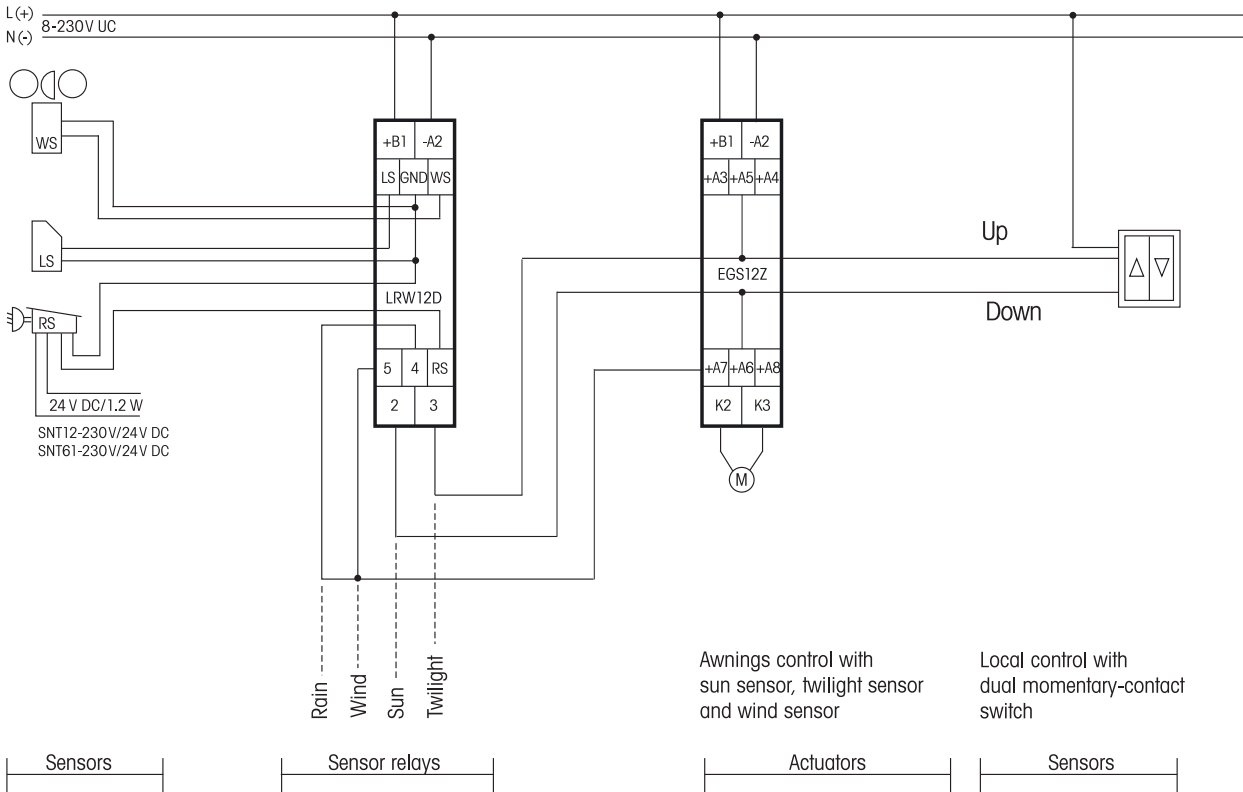

When controlling with 230 V (+B1= L, -A2=N) the 230 V awning motor is directly connected to K2, K3 and N. Otherwise a motor isolating relay MTR12-UC must be interconnected to K2/K3.

ROLLER SHUTTER CONTROL WITH EGS12Z2-UC

For clarity, the L and N connections for the 230 V motors are not shown.

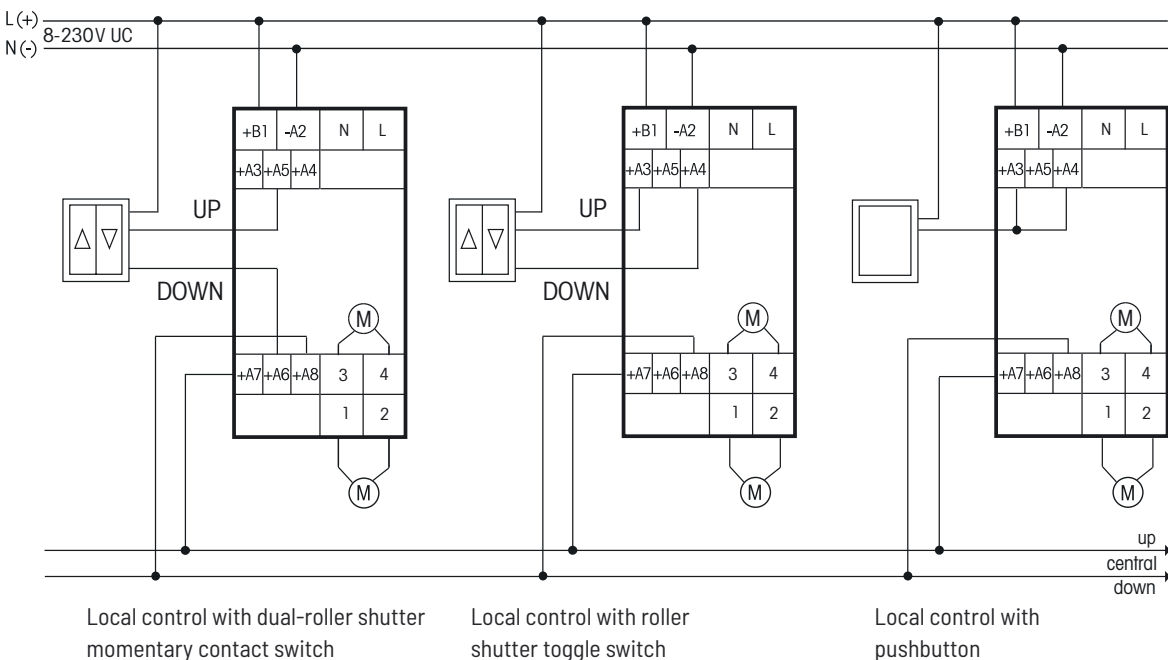

16-12

TYPICAL CIRCUIT EXAMPLES OF A ROLLER SHUTTER CONTROL

ROLLER SHUTTER CONTROL WITH EGS12Z-UC

For clarity, the L and N connections for the 230V motors are not shown.

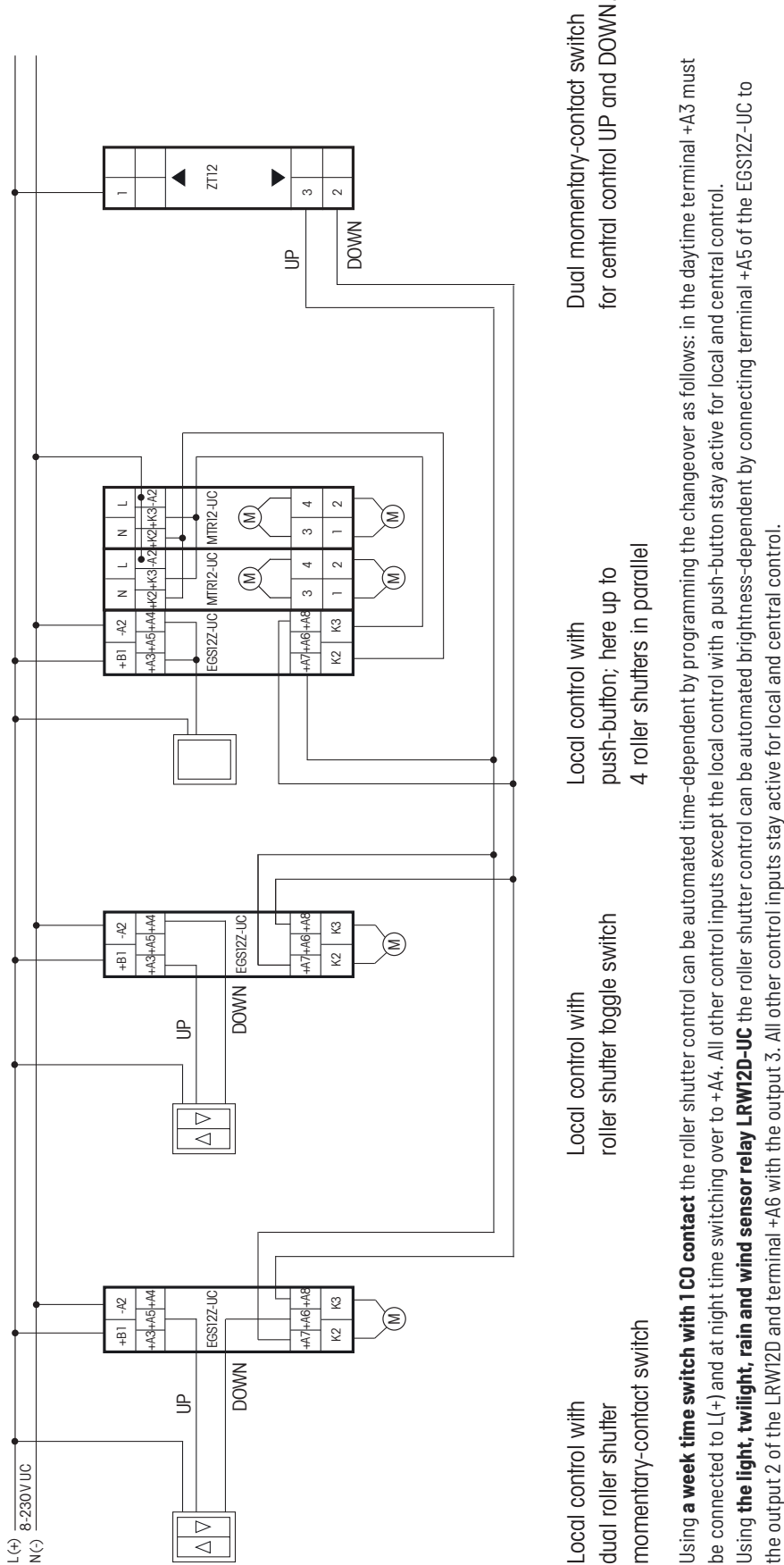

Local control with dual roller shutter momentary-contact switch

Local control with roller shutter toggle switch

Local control with push-button; here up to 4 roller shutters in parallel

Dual momentary-contact switch for central control UP and DOWN.

Using a **week time switch with 1 CO contact** the roller shutter control can be automated time-dependent by programming the changeover as follows: in the daytime terminal +A3 must be connected to L (+) and at night time switching over to +A4. All other control inputs except the local control with a push-button stay active for local and central control. Using **the light, twilight, rain and wind sensor relay LRW12D-UC** the roller shutter control can be automated brightness-dependent by connecting terminal +A5 of the EGS12Z-UC to the output 2 of the LRW12D and terminal +A6 with the output 3. All other control inputs stay active for local and central control.