

**TLZ12  
TLZ12D  
TLZ61NP  
NLZ12NP**



**MAKE A CONFIDENT STRIDE THROUGH THE STAIRWELL WITH ELTAKO STAIRCASE TIME SWITCHES.**







# Staircase time switches and off-delay timers

<b>Selection table staircase time switches and off-delay timers</b>	<b>15 - 2</b>
<b>Staircase time switch <a href="#">TLZ12-8plus</a> - The Standard</b>	<b>15 - 3</b>
<b>Staircase time switch <a href="#">TLZ12-8</a> - The Simple</b>	<b>15 - 4</b>
<b>Staircase time switch <a href="#">TLZ12G-230V+UC</a> - The Noiseless</b>	<b>15 - 5</b>
<b>Digital settable staircase time switch <a href="#">TLZ12D-plus</a> - The Allrounder</b>	<b>15 - 6</b>
<b>Staircase time switch <a href="#">TLZ12-9</a> for older installations</b>	<b>15 - 7</b>
<b>Staircase time switch <a href="#">TLZ61NP-230V</a></b>	<b>15 - 8</b>
<b>Staircase time switch <a href="#">TLZ61NP-230V+UC</a></b>	<b>15 - 9</b>
<b>Technical data staircase time switches</b>	<b>15 - 10</b>
<b>Off-delay timer <a href="#">NLZ12NP-230V+UC</a></b>	<b>15 - 11</b>
<b>Off-delay timer <a href="#">NLZ61NP-UC</a></b>	<b>15 - 12</b>
<b>Technical data off-delay timer</b>	<b>15 - 13</b>

# THE COMPLETE RANGE

From the "simple" to the "all-rounder".  
Staircase light actuators for every challenge.  
For 3- and 4-wire circuits.  
Of course for LED, ESL and incandescent lamps.

- The simple, TLZ12-8 with noiseless electronics.
- The standard, TLZ12-8plus with switch-off warning according to DIN 18015-2 and permanent light.
- The noiseless, TLZ12G-230V + UC with solid-state relay and additional galvanically isolated universal control voltage.
- The all-rounder, TLZ12D-plus additionally with motion detector control input BM.

Page	15-3	15-4	15-5	15-6	15-7	15-8	15-9	15-11	15-12	
		TLZ12-8plus	TLZ12-8	TLZ12G-230V+UC	TLZ12D-plus	TLZ12-9	TLZ6INP-230V	TLZ6INP-230V+UC	NLZ12NP-230V+UC	NLZ6INP-UC
Modular device for mounting on DIN rail EN 60715 TH35, number of modules 18 mm each	1	1	1	1	1			1		
Built-in device for installation (e.g. flush-mounting box)							■	■	■	
230 V LED lamps (W)	up to 600	up to 100	up to 400	up to 600	up to 600	up to 600	up to 600	up to 600		
Incandescent lamp load (W)	2300	2000	400	2300	2300	2000	2000			
For energy saving lamps ESL*	■	■	■	■	■	■	■			
For 230 V LED lamps	■	■	■	■	■	■	■			
Switch-off early warning function switchable <sup>1)</sup>	■		■	■	■	■	■			
Variable time range up to	30 min	12 min	30 min	99 min	12 min	12 min	12 min	12 min	12 min	
Low standby loss 	■	■	■	■	■	■	■	■	■	
230 V control voltage	■	■	■	■	■	■	■	■	■	
Universal control voltage (additionally) 8 to 230 V UC 	■		■	■				■	■	
Glow lamp current mA 	50	50	50	50	50	50	50			
Double connections pushbutton and lamp	■	■	■							
Single connections below					■					
Automatic detection 3-/4-wire circuit	■	■	■	■			■	■		
3-wire circuit, without attic lighting					■					
Resettable	■	■	■	■			■	■		
Permanent light and switch-off logics with pushbutton switchable	■		■	■			■	■		
Incrementing <sup>2)</sup>	■		■	■			■	■		
Separate continuous light switch	■	■	■	■	■					
Additional input for motion control				■						
With multifunction: TLZ, ESV, ES and ER	■		■	■			without ER	without ER	■	
Bistable relay 	■			■	■	■	■	■		
Zero passage switching 	■		■	■	■	■	■	■	■	

\* ESL = abbr. for energy saving lamps

<sup>1)</sup> As stipulated in DIN 18015-2 under 4.2 the following should be taken into account: For lighting systems in staircases, corridors, arcades or elevator areas it is recommended to use the switch off early warning function to prevent sudden darkness. If the switch-off early warning function is active, the light starts flickering approx. 30 seconds before time-out and is repeated three times at decreasing time intervals.

<sup>2)</sup> Time can be extended: Within the first second after switching on or resetting the time can be extended by pressing the pushbutton repeatedly up to three times (incrementing). Each operation increments the set time once.

# STAIRCASE TIME SWITCH TLZ12-8PLUS THE STANDARD

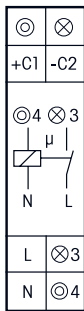

## Function rotary switches

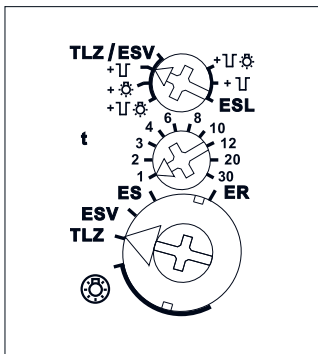

## Typical connections

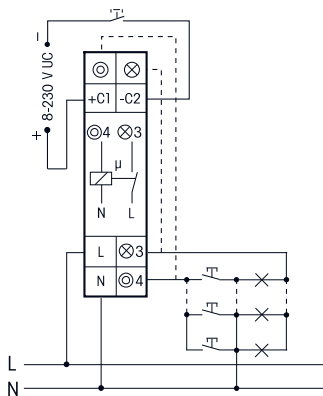

3-wire circuit, resettable.

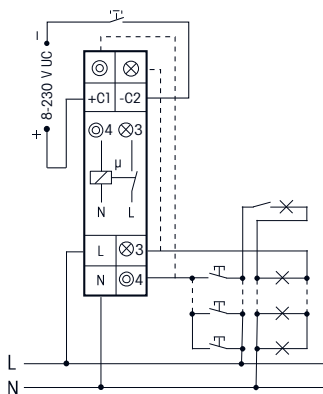

4-wire circuit with attic lighting, resettable.

Technical data page 15-10.  
Housing for operating instructions GBA14,  
see accessories, chapter Z.

Recommended retail prices excluding VAT.

# TLZ12-8plus



**1 NO contact not potential free 16 A/250 V AC. 230 V LED lamps up to 600 W, energy saving lamps ESL up to 200 W, incandescent lamps up to 2300 W. Control voltage 230 V and/or 8..230 V UC. Switch-off early warning and permanent light by pushbutton switchable. Standby loss 0.7 watt only. With ESL optimisation and multifunction.**

Modular device for DIN EN 60715 TH35 rail mounting.

1 module = 18 mm wide, 58 mm deep.

**Zero passage switching** to protect contacts and lamps.

**The noiseless electronics** do not even bother the sensitive ear - unlike many synchronous motors with mechanical gears.

**By using a bistable relay coil power loss and heating is avoided even in the on mode.**

The switched consumer may not be connected to the mains before the short automatic synchronisation after installation has terminated.

Control voltage, supply voltage and switching voltage 230 V. In addition electrically isolated universal voltage from 8 to 230 V UC. 3-wire and 4-wire circuits, resettable, with attic lighting if 4-wire circuit.

**Automatic detection of the method of connection.**

**Glow lamp current up to 50 mA**, dependent on the ignition voltage of the glow lamps.

Precise variable time range from 1 to 30 minutes, settable by minute scale.

**Permanent light switch** with the big rotary switch.

If the function TLZ is set, the lighting is switched on again after a power failure provided the set time has not yet elapsed.

**With double connections** for pushbutton and lamp in order to connect either above or below or only below.

**If switch-off early warning function is switched on**, the light starts flickering approx. 30 seconds before time-out and is repeated three times at decreasing time intervals.

**If permanent light by pushbutton is switched on**, permanent light can be switched on by pressing the pushbutton longer than 1 second. This is switched off automatically after 60 minutes or by pressing the pushbutton longer than 2 seconds.

If both switch-off early warning function and permanent light by pushbutton are switched on, the switch-off early warning function is activated before the permanent light switches off.

**When energy saving lamps ESL are completely or partially switched, then set the switch-off early warning and the permanent light by pushbutton on the right hand side of the rotary switch.**

If the function TLZ is selected **the time can be extended** within the first second after switching on or resetting **by pressing the pushbutton repeatedly up to three times** (incrementing). Each momentary-contact control increments the set time once.

**With multifunction:** The following functions can be selected optionally: **ES** (impulse switch), **ER** (relay), **ESV** (impulse switch with release delay).

If the function ESV is set the time ranges (t), which can be set with the middle rotary switch are as follows: 1 = 2 min, 2 = 5 min, 3 = 10 min, 4 = 15 min, 6 = 25 min, 8 = 35 min, 10 = 45 min, 12 = 60 min, 20 = 90 min, 30 = 120 min. In this function the impulse switch automatically disconnects after the set delay is timed out, if a manual OFF command has not been given. Switch-off early warning and permanent light by pushbutton can also be switched on in this position. Forgotten permanent light is switched off after 2 hours.

☐ = Switch-off early warning function

☼ = Permanent light by pushbutton

☐☼ = Switch-off early warning function and permanent light by pushbutton

⊗ = Permanent light switched on (all click-stop positions)

TLZ/ESV/ES/ER = The set function is active

<b>TLZ12-8plus</b>	1 NO contact 16 A	EAN 4010312401613	<b>48,60 €/pc.</b>
--------------------	-------------------	-------------------	--------------------

## STAIRCASE TIME SWITCH TLZ12-8 THE SIMPLE

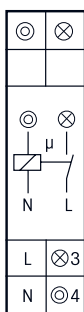

### Function rotary switches

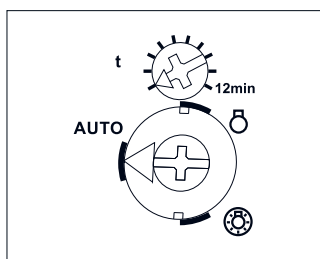

### Typical connections

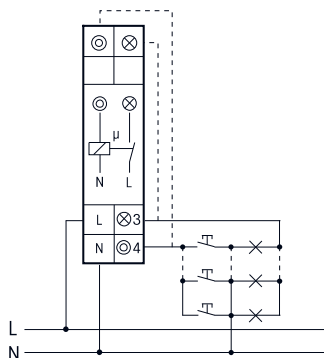

3-wire circuit, resettable.

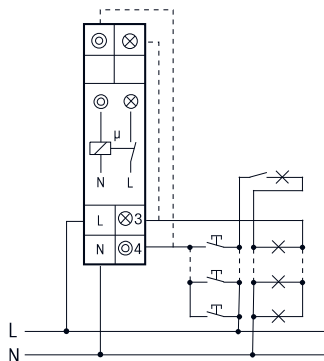

4-wire circuit with attic lighting, resettable.

Technical data page 15-10.  
Housing for operating instructions GBA14,  
see accessoires, chapter Z.

## TLZ12-8



**1 NO contact not potential free 16 A/250 V AC. 230 V LED lamps and energy saving lamps ESL up to 100 W, incandescent lamps up to 2000 W. Without switch-off early warning. Standby loss 0.7 watt only.**

Modular device for DIN EN 60715 TH35 rail mounting.

1 module = 18 mm wide, 58 mm deep.

**The noiseless electronics** do not even bother the sensitive ear - unlike many synchronous motors with mechanical gears.

230 V control voltage, supply voltage and switching voltage.

Variable time range from approx. 0.2 to 12 minutes.

Glow lamp current up to 50 mA, dependent on the ignition voltage of the glow lamps.

**Own permanent light switch** with the big rotary switch.

3-wire and 4-wire circuits, resettable, with attic lighting if 4-wire circuit.

**Automatic detection of the method of connection.**

Without switch-off early warning function and without zero passage switching.

**With double connections** for pushbutton and lamp in order to connect either above or below or only below.

⊖ = Function switched off

⊕ = Permanent light switched on

AUTO = The set function is active

TLZ12-8	1 NO contact 16 A	EAN 4010312401637	36,30 €/pc.
---------	-------------------	-------------------	-------------

# STAIRCASE TIME SWITCH TLZ12G-230V+UC THE NOISELESS

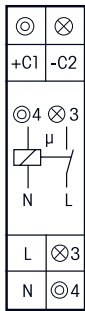

## Function rotary switches

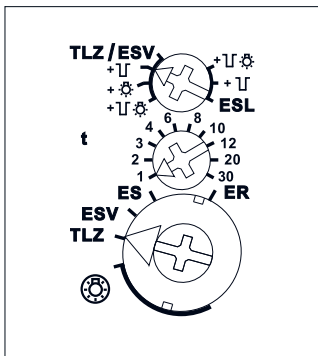

## Typical connections

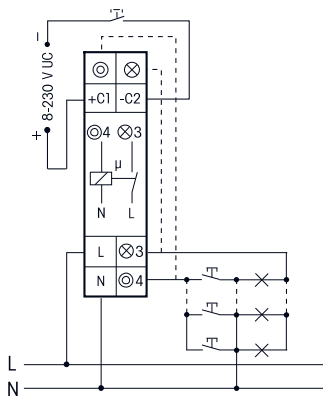

3-wire circuit, resettable.

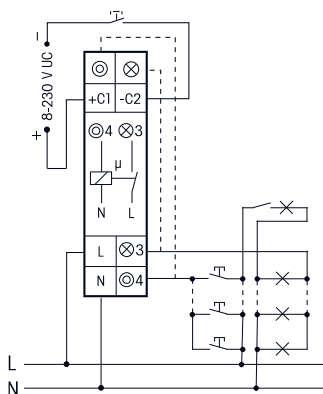

4-wire circuit with attic lighting, resettable.

Technical data page 15-10.  
Housing for operating instructions GBA14, see accessories, chapter Z.

Recommended retail prices excluding VAT.

# TLZ12G-230V+UC



**Noiseless solid-state relay not potential-free. 230 V LED lamps and energy saving lamps ESL up to 400 W, incandescent lamps up to 400 W. Switch-off early warning and pushbutton permanent light switchable. Standby loss 0.4 watt only. With ESL optimisation and multifunction.**

Modular device for DIN-EN 60715 TH35 rail mounting.  
1 module = 18 mm wide, 58 mm deep.

**Zero passage switching** to protect lamps.

**The noiseless electronics and zero passage switching** do not even bother the sensitive ear - unlike many synchronous motors with mechanical gears.

Control, supply and switching voltage 230 V. Additionally 8 to 230 V UC electrically isolated universal control voltage. 3-wire and 4-wire circuits, resettable, with attic lighting if 4-wire circuit. **Automatic detection of the method of connection.**

**Glow lamp current up to 50 mA**, dependent on the ignition voltage of the glow lamps.

Precise variable time range from 1 to 30 minutes, settable by minute scale.

**Permanent light switch** with the big rotary switch.

If the function TLZ is set, the lighting is switched on again after a power failure provided the set time has not yet elapsed.

With double connections for pushbutton and lamp in order to connect either above or below or only below. **If switch-off early warning function is switched on** the light starts flickering approx. 30 seconds before time-out and is repeated three times at decreasing time intervals.

**If pushbutton permanent light is switched on** permanent light can be switched on by pressing pushbutton longer than 1 second. This is switched off automatically after 60 minutes or by pressing pushbutton longer than 2 seconds.

If both switch-off early warning function and permanent light pushbutton are switched on, the switch-off early warning function is activated before the permanent light switches off.

**When energy saving lamps ESL are completely or partially switched, then set the switch-off early warning and the pushbutton permanent light on the right hand side of the rotary switch.**

If the function TLZ is selected **the time can be extended** within the first second after switching on or resetting **by pressing the pushbutton repeatedly up to three times** (incrementing). Each momentary-contact control increments the set time once.

With multifunction: the following functions can be selected optionally: ES (impulse switch), ER (relay), ESV (impulse switch with release delay).

If the function ESV is set the time ranges (t) which can be set with the middle rotary switch are as follows: 1 = 2 min, 2 = 5 min, 3 = 10 min, 4 = 15 min, 6 = 25 min, 8 = 35 min, 10 = 45 min, 12 = 60 min, 20 = 90 min, 30 = 120 min. In this function the impulse switch automatically disconnects after the set delay is timed out, if a manual OFF command has not been given. Switch-off early warning and pushbutton permanent light can be switched on additionally in this position as well. Forgotten permanent light is switched off after 2 hours.

⏏ = Switch-off early warning function

⏏ = Permanent light by pushbutton

⏏ = Switch-off early warning function and permanent light by pushbutton

⊕ = Permanent light switched on (all click-stop positions)

TLZ/ESV/ES/ER = The set function is active

<b>TLZ12G-230V+UC</b>	Solid state relays 400 W	EAN 4010312401460	<b>55,30 €/pc.</b>
-----------------------	--------------------------	-------------------	--------------------

## DIGITAL SETTABLE STAIRCASE TIME SWITCH TLZ12D-PLUS THE ALLROUNDER

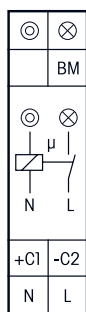

### Typical connections

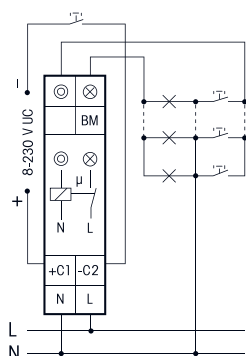

3-wire circuit, resettable.

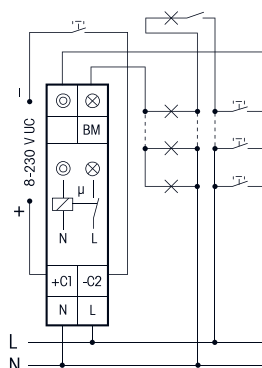

4-wire circuit with attic lighting, resettable.

## TLZ12D-plus



**1 NO contact not potential free 16 A/250 V AC. 230 V LED lamps up to 600 W, energy saving lamps ESL up to 200 W, incandescent lamps up to 2300 W. Control voltage 230 V and/or 8..230 V UC. Switch-off early warning and permanent light by pushbutton switchable. Standby loss 0.5 watt only. With ESL optimisation and multifunction.**

Modular device for DIN EN 60715 TH35 rail mounting. 1 module = 18 mm wide, 58 mm deep.

The functions and times are entered using the MODE and SET keys as described in the operating manual and indicated on the LC display. A keylock function is provided.

**Zero passage switching** to protect contacts and lamps.

**The noiseless electronics** do not even bother the sensitive ear - unlike many synchronous motors with mechanical gears.

**By using a bistable relay coil power loss and heating is avoided even in the on mode.**

The switched consumer may not be connected to the mains before the short automatic synchronisation after installation has terminated.

Control voltage, supply voltage and switching voltage 230 V. In addition electrically isolated universal voltage from 8 to 230 V UC. 3-wire and 4-wire circuits, resettable, with attic lighting if 4-wire circuit.

**Automatic detection of the method of connection.**

**Glow lamp current up to 50 mA**, dependent on the ignition voltage of the glow lamps.

Precise variable time range from 1 to 99 minutes.

Separate continuous light pushbutton with projecting SET button in the functions STS, ISO, IS and R.

**With motion detector control input BM**, which converts the input signal into a control impulse if the function STS is set. In this case the permanent light by pushbutton function is not active.

If the function STS is set, the lighting is switched on again after a power failure provided the set time has not yet elapsed.

The elapsed period is shown in the middle of the display. The set time flashes at the bottom edge of the display until the set period elapses. **The accrued switch-on time** is displayed there outside the elapsed time, first in hours (h), then in months (m) with 1 digit after the decimal point.

When the set time flashes but the elapsed time does not change, a control pushbutton is inhibited.

**If switch-off early warning function is switched on**, the light starts flickering in time variable from 10 to 50 seconds before time-out and is repeated three times at decreasing time intervals.

**If permanent light by pushbutton is switched on**, permanent light can be switched on by pressing the pushbutton longer than 1 second. This is switched off automatically after time variable from 0.5 to 10 hours or by pressing the pushbutton longer than 2 seconds. This function is not active at the BM input.

If both switch-off early warning function and permanent light by pushbutton are switched on, the switch-off early warning function is activated before the permanent light switches off.

**If energy saving lamps are switched completely or partially, activate position 'ESL' in the menu guidance. This is indicated by a + sign next to the abbreviation for the function at the top of the display.**

If the function STS is selected **the time can be extended** within the first second after switching on or resetting **by pressing the pushbutton repeatedly up to three times** (incrementing). Each momentary-contact control increments the set time once. This function is not active at the BM input.

**With multifunction:** Switchable to the functions **IS** (impulse switch), **R** (relay), **ISO** (impulse switch with off-delay) and **HC** (hour counter). After setting the required function, the function can be blocked. An arrow on the right of the abbreviation indicates the blocking status.

**ISO:** The impulse switch automatically disconnects after the set delay from 0.1 to 9.9 hours is timed out, provided there is no manual OFF command. Switch-off early warning, permanent light by pushbutton and ESL are also switchable if the function ISO is set.

**HC:** As long as the pushbutton input is excited, the + sign is indicated next to the abbreviation for the function HC at the top of the display. The time is added and indicated at the bottom of the display. Initially up to 9999 hours (h), then automatic change-over to months (m) each with 730 hours and display with 1 digit after the decimal point. The relay is not switched on if the function HC is set.

Menu guidance with selectable languages German, English or French as described in the attached operating instructions.

Technical data page 15-10.

Housing for operating instructions GBA14, see accessories, chapter Z.

TLZ12D-plus	1 NO contact 16 A	EAN 4010312401712	52,50 €/pc.
-------------	-------------------	-------------------	-------------



# TLZ12-9



**1 NO contact not potential free 16 A/250 V AC. 230 V LED lamps up to 600 W, energy saving lamps ESL up to 200 W, incandescent lamps up to 2300 W. Switch-off early warning switchable. Standby loss 0.7 watt only.**

Modular device for DIN EN 50022 rail mounting. 1 module = 18 mm wide, 58 mm deep.

**Zero passage switching** to protect contacts and lamps.

**The noiseless electronics** do not even bother the sensitive ear - unlike many synchronous motors with mechanical gears.

**By using a bistable relay coil power loss and heating is avoided even in the onmode.**

The switched consumer may not be connected to the mains before the short automatic synchronisation after installation has terminated.

230 V control voltage, supply voltage and switching voltage.

Glow lamp current up to 50 mA, dependent on the ignition voltage of the glow lamps.

Precise variable time range from 1 to 12 minutes, settable by minute scale.

**Own permanent light switch** with the big rotary switch.

3-wire circuit with attic lighting, not resettable. Only for retrofitting of existing systems.

After a power failure the lighting is switched on again in case the set time has not elapsed yet.

**If switch-off early warning function** is switched on the light starts flickering approx. 30 seconds before time-out and is repeated three times at decreasing time intervals.

## Function rotary switches

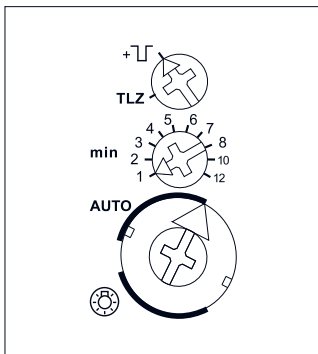

## Typical connection

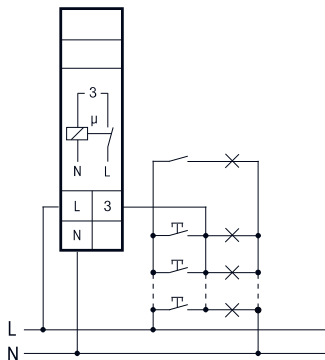

3-wire circuit with attic lighting, not resettable.

Technical data page 15-10.  
Housing for operating instructions GBA14,  
see accessoires, chapter Z.

⏏ = Switch-off early warning function

⊙ = Permanent light switched on (all click-stop positions)

AUTO = The set function is active (all click-stop positions)

TLZ12-9	1 NO contact 16 A	EAN 4010312401620	47,20 €/pc.
---------	-------------------	-------------------	-------------



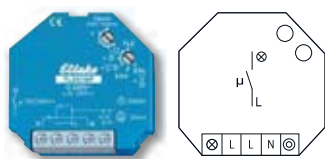

Function rotary switches

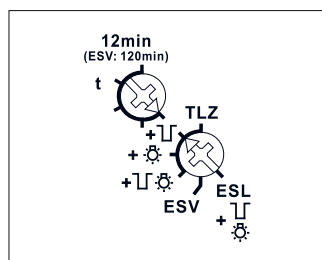

Standard setting ex works.

Typical connections

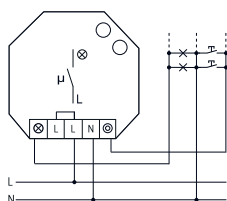

3-wire circuit, resettable.

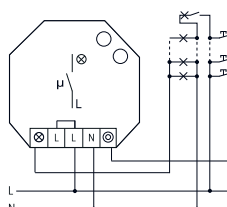

4-wire circuit with attic lighting, resettable.

Technical data page 15-10.

# TLZ61NP-230V



**1 NO contact not potential free 10 A/250 V AC. 230 V LED lamps up to 600 W, energy saving lamps ESL up to 200 W, incandescent lamps up to 2000 W. Switch-off early warning and permanent light by pushbutton switchable. Standby loss 0.7 watt only. With ESL optimisation.**

Built-in device for installation. 45 mm long, 45 mm wide, 18 mm deep.

**Zero passage switching** to protect contacts and lamps.

**By using a bistable relay coil power loss and heating is avoided even in the on mode.**

The switched consumer may not be connected to the mains before the short automatic synchronisation after installation has terminated.

Control voltage, supply voltage and switching voltage 230 V. With infinitely variable time range from 1 to 12 minutes.

50 mA glow lamp current, dependent on the ignition voltage of the glow lamps.

3-wire and 4-wire circuits, resettable, with attic lighting if 4-wire circuit.

Automatic detection of the method of connection.

After a power failure the lighting is switched on again in case the set time has not elapsed yet.

**If switch-off early warning function** **is switched on**, the light starts flickering approx. 30 seconds before time-out and is repeated three times at decreasing time intervals.

**If permanent light by pushbutton** **is switched on**, permanent light can be switched on by pressing the pushbutton longer than 1 second. This is switched off automatically after 60 minutes or by pressing the pushbutton longer than 2 seconds.

If both switch-off early warning function and permanent light by pushbutton are switched on, the switch-off early warning function is activated before the permanent light switches off.

**When energy saving lamps ESL are completely or partially switched, then set the switch-off early warning with the pushbutton permanent light ESL on the lower rotary switch.**

If the function TLZ is selected the **time** can be **extended** within the first second after switching on or resetting by pressing the pushbutton repeatedly up to three times (incrementing).

Each momentary-contact control increments the set time once.

The function **ESV**, impulse switch with release delay up to 120 minutes, can be selected optionally. If this function is set it is automatically disconnected after the set delay is timed out if a manual OFF command has not been given.

If the timing period is set to minimum in the function **ESV**, the release delay is switched off.

The standard impulse switch function **ES** is then set.

= Switch-off early warning function

= Permanent light by pushbutton

= Switch-off early warning function and permanent light by pushbutton

<b>TLZ61NP-230V</b>	1 NO contact 10 A	EAN 4010312400791	<b>46,30 €/pc.</b>
---------------------	-------------------	-------------------	--------------------

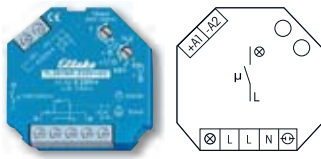

# TLZ61NP-230V+UC



**1 NO contact not potential free 10 A/250 V AC. 230 V LED lamps up to 600 W, energy saving lamps ESL up to 200 W, incandescent lamps up to 2000 W. Switch-off early warning and permanent light by push-button switchable. Standby loss 0.7 watt only. With ESL optimisation.**

## Function rotary switches

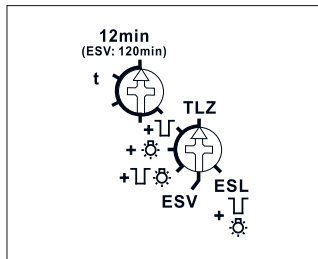

Standard setting ex works.

## Typical connections

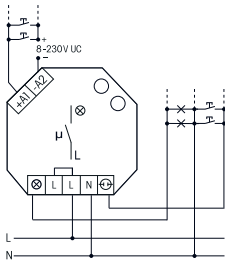

3-wire circuit, resettable

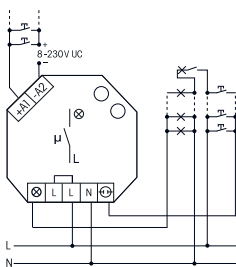

4-wire circuit with attic lighting, resettable

Technical data page 15-10.

Built-in device for installation. 45 mm long, 45 mm wide, 18 mm deep.

**Zero passage switching** to protect contacts and lamps.

**By using a bistable relay coil power loss and heating is avoided even in the on mode.**

The switched consumer may not be connected to the mains before the short automatic synchronisation after installation has terminated.

Control voltage, supply voltage and switching voltage 230 V. In addition electrically isolated universal voltage from 8 to 230 V UC.

With infinitely variable time range from 1 to 12 minutes. 50 mA glow lamp current, dependent on the ignition voltage of the glow lamps.

3-wire and 4-wire circuits, resettable, with attic lighting if 4-wire circuit.

Automatic detection of the method of connection.

After a power failure the lighting is switched on again in case the set time has not elapsed yet.

**If switch-off early warning function** **is switched on**, the light starts flickering approx. 30 seconds before time-out and is repeated three times at decreasing time intervals.

**If permanent light by pushbutton** **is switched on**, permanent light can be switched on by pressing the pushbutton longer than 1 second. This is switched off automatically after 60 minutes or by pressing the pushbutton longer than 2 seconds.

If both switch-off early warning function and permanent light by pushbutton are switched on, the switch-off early warning function is activated before the permanent light switches off.

**When energy saving lamps ESL are completely or partially switched, then set the switch-off early warning with the pushbutton permanent light ESL on the lower rotary switch.**

If the function TLZ is selected the **time** can be **extended** within the first second after switching on or resetting by pressing the pushbutton repeatedly up to three times (incrementing).

Each momentary-contact control increments the set time once.

The function **ESV**, impulse switch with release delay up to 120 minutes, can be selected optionally. If this function is set it is automatically disconnected after the set delay is timed out if a manual OFF command has not been given.

If the timing period is set to minimum in the function **ESV**, the release delay is switched off.

The standard impulse switch function **ES** is then set.

= Switch-off early warning function

= Permanent light by pushbutton

= Switch-off early warning function and permanent light by pushbutton

<b>TLZ61NP-230V+UC</b>	1 NO contact 10A	EAN 4010312400739	<b>49,60 €/pc.</b>
------------------------	------------------	-------------------	--------------------

## TECHNICAL DATA STAIRCASE TIME SWITCHES

Type	TLZ12-8plus <sup>b)</sup> TLZ12D-plus <sup>b)</sup> TLZ12-9 <sup>b)</sup>	TLZ12G	TLZ12-8	TLZ61NP <sup>b)</sup> TLZ61NP+UC <sup>b)</sup>
<b>Contacts</b>				
Contact material/contact gap	AgSnO <sub>2</sub> /0.5 mm	Opto-Triac	AgSnO <sub>2</sub> /0.5 mm	AgSnO <sub>2</sub> /0.5 mm
Spacing of control connections/contact Spacing of control connections C1-C2 or A1-A2/contact	3 mm 6 mm	3 mm 6 mm	3 mm -	3 mm 6 mm
Test voltage control connection/contact Test voltage C1-C2 or A1-A2/contact	2000 V 4000 V	- 4000 V	2000 V -	2000 V 4000 V
Rated switching capacity	16 A/250 V AC	up to 400 W	16 A/250 V AC	10 A/250 V AC
230 V LED lamps	up to 600 W <sup>2)</sup> I on ≤ 120 A/5 ms	up to 400 W <sup>2)</sup> I on ≤ 120 A/20 ms	up to 100 W <sup>2)</sup> I on ≤ 30 A/20 ms	up to 600 W <sup>2)</sup> I on ≤ 120 A/5 ms
Incandescent lamp and halogen lamp load <sup>1)</sup> 230 V, I on ≤ 70 A/10 ms	2300 W	up to 400 W	2000 W TLZ12-9: 2300 W	2000 W
Fluorescent lamp load with KVG* in lead-lag circuit or non compensated	1000 VA	-	500 VA TLZ12-9: 1000 VA	1000 VA
Fluorescent lamp load with KVG* shunt-compensated or with EVG*	500 VA	up to 400 VA	500 VA	500 VA
Compact fluorescent lamps with EVG* and energy saving lamps ESL	up to 200 W <sup>2)</sup>	up to 400 W <sup>2)</sup>	up to 100 W <sup>2)</sup>	up to 200 W <sup>2)</sup>
Life at rated load, cos φ = 1 or for incandescent lamps 1000 W at 100/h	> 10 <sup>5</sup>	∞	> 10 <sup>5</sup>	> 10 <sup>5</sup>
Life at rated load, cos φ = 0.6 at 100/h	> 4x10 <sup>4</sup>	∞	> 4x10 <sup>4</sup>	> 4x10 <sup>4</sup>
Max. operating cycles	10 <sup>3</sup> /h	10 <sup>3</sup> /h	10 <sup>3</sup> /h	10 <sup>3</sup> /h
Maximum conductor cross-section (3-fold terminal)	6 mm <sup>2</sup> (4 mm <sup>2</sup> )	6 mm <sup>2</sup> (4 mm <sup>2</sup> )	6 mm <sup>2</sup> (4 mm <sup>2</sup> )	4 mm <sup>2</sup>
Two conductors of same cross-section (3-fold terminal)	2.5 mm <sup>2</sup> (1.5 mm <sup>2</sup> )	2.5 mm <sup>2</sup> (1.5 mm <sup>2</sup> )	2.5 mm <sup>2</sup> (1.5 mm <sup>2</sup> )	1.5 mm <sup>2</sup>
Screw head	slotted/crosshead, pozidriv	slotted/crosshead, pozidriv	slotted/crosshead, pozidriv	slotted/crosshead
Type of enclosure/terminals	IP50/IP20	IP50/IP20	IP50/IP20	IP30/IP20
<b>Electronics</b>				
Time on	100%	100%	100%	100%
Max./min. temperature at mounting location	+50°C/-20°C	+50°C/-20°C	+50°C/-20°C	+50°C/-20°C
Standby loss (activ power)	0.7 W; TLZ12D-plus: 0.5 W	0.4 W	0.7 W	0.7 W
Control current local at 230 V (<10 s) ± 20%	5(100)mA	5(100)mA	5(100)mA	5(100)mA
Control current universal control voltage 8/12/24/230 V (<10 s) ± 20%	2/4/9/5(100)mA	2/4/9/5(100)mA	-	2/4/9/5(100)mA (nur TLZ61NP+UC)
Max. parallel capacitance (approx. length) of individual control lead at 230 V AC	0.06 µF (200 m) C1/C2: 0.9 µF (3000 m)	0.9 µF (3000 m)	0.06 µF (200 m)	0.06 µF (200 m) A1-A2: 0.3 µF (1000 m)

\* EVG = electronic ballast units; KVG = conventional ballast units

<sup>b)</sup> Bistable relay as relay contact. The switched consumer may not be connected to the mains before the short automatic synchronisation after installation has terminated.

<sup>1)</sup> Applies for lamps with max. 150 W.

<sup>2)</sup> Usually applies for dimmable 230 V LED lamps and dimmable energy saving lamps. Due to different lamp electronics and depending on the manufacturer, the maximum number of lamps may be limited, especially if the wattage of the individual lamps is very low (e.g. with 2 W LEDs).

To comply with DIN VDE 0100-443 and DIN VDE 0100-534, a Type 2 or Type 3 surge protection device (SPD) must be installed.

# THE FRESH AIR PROFESSIONALS

Fresh air in the bathroom with the professional off-delay timers NLZ, also known as off-delay relay. Accurate timing is self-evident for this electronic device as well as noiseless operation. The off-delay timers with universal voltage offer additional appli-

cations as here even different potentials for switch and fan can be applied. The NP types have a settable operate delay up to 12 minutes.

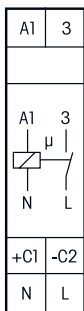

## NLZ12NP-230V+UC



**1 NO contact not potential free 16 A/250 V AC. Standby loss 0.5 watt only.**

Modular device for DIN EN 60715 TH35 rail mounting.  
1 module = 18 mm wide, 58 mm deep.

**Zero passage switching** to protect contacts and consumers.

State-of-the-art hybrid technology combines advantages of nonwearing electronic control with high capacity of special relays.

Control, supply and switching voltage 230 V. Additionally 8 to 230 V UC electrically isolated universal control voltage.

Very low switching noise.

Off-delay time settable from 1 to 12 min with the top rotary switch. Operating delay settable from 0 to 12 minutes with the middle rotary switch. Permanent ON and permanent OFF with the bottom rotary switch.

**Function:** When the control contact (light switch) is closed the operate delay AV starts (if not set '0 minutes'), on time-out the fan is switched on. The set release delay RV (delay time) starts when the control contact opens and if a set operating delay has elapsed.

The fan switches off on time-out.

**This off-delay timer can be controlled by all dimmer switches EUD12 and EUD61 even in the minimum dimming position.**

### Function rotary switches

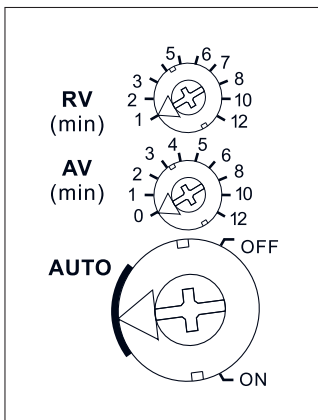

**RV** = release delay  
(delay time)  
**AV** = operating delay

### Typical connections

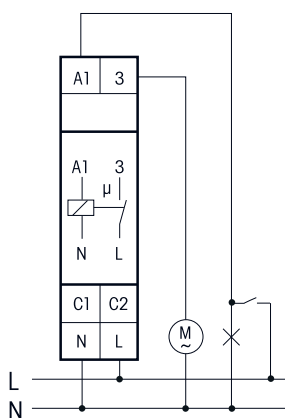

Fan control through light switch

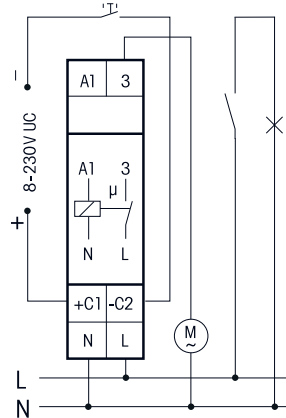

Fan control through ultra low voltage door contact, light is controlled separately

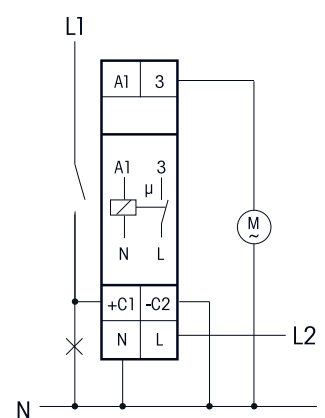

Fan control through light switch in case of different potentials on switch and fan

Technical data page 15-13.  
Housing for operating instructions GBA14,  
see accessoires, chapter Z.

<b>NLZ12NP-230V+UC</b>	1 NO contact 16 A	EAN 4010312602911	<b>49,10 €/pc.</b>
------------------------	-------------------	-------------------	--------------------

## OFF-DELAY TIMER NLZ61NP-UC

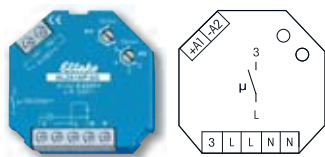

### Function rotary switches

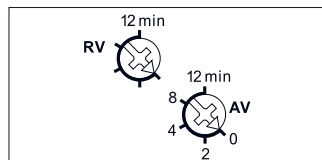

Standard setting ex works.

# NLZ61NP-UC



**1 NO contact not potential free 10 A/250 V AC. Standby loss 0.7 watt only.**

Built-in device for installation. 45 mm long, 45 mm wide, 18 mm deep.

**Zero passage switching** to protect contacts and consumers.

State-of-the-art hybrid technology combines advantages of nonwearing electronic control with high capacity of special relays.

8 to 230 V UC universal control voltage, electrically isolated from the 230 V supply voltage and switching voltage.

**By using a bistable relay coil power loss and heating is avoided even in the on mode.**

The switched consumer may not be connected to the mains before the short automatic synchronisation after installation has terminated. The top rotary switch varies the off-delay time from 1 to 12 minutes.

Operating delay settable from 0 to 12 minutes with the lower rotary switch.

**Function:** When the control contact (light switch) is closed the operating delay AV starts (if not set '0 minutes'), on time-out the fan is switched on. The set release delay RV (delay time) starts when the control contact opens and if a set operating delay has elapsed. The fan switches off on time-out.

**This off-delay timer can be controlled by all dimmer switches EUD12 and EUD61 even in the minimum dimming position.**

### Typical connections

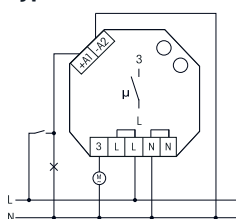

Fan control through light switch

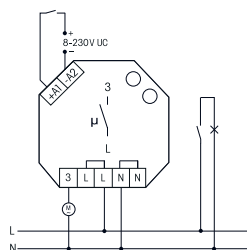

Fan control through ultra low voltage door contact, light is controlled separately

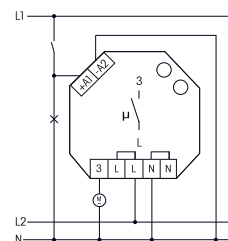

Fan control through light switch in case of different potentials on switch and fan

Technical data page 15-13.

<b>NLZ61NP-UC</b>	1 NO contact 10A	EAN 4010312603048	<b>46,70 €/pc.</b>
-------------------	------------------	-------------------	--------------------

Type	NLZ12NP	NLZ61NP-UC <sup>b)</sup>
<b>Contacts</b>		
Contact material/contact gap	AgSnO <sub>2</sub> /0.5 mm	AgSnO <sub>2</sub> /0.5 mm
Spacing of control connections/contact Spacing of control connections C1-C2 or A1-A2/contact	3 mm 6 mm	3 mm 6 mm
Test voltage control connection/contact Test voltage C1-C2 or A1-A2/contact	2000 V 4000 V	2000 V 4000 V
Rated switching capacity	16 A/250 V AC	10 A/250 V AC
Inductive load cos φ = 0,6/230 V AC Inrush current ≤ 35 A	650 W	650 W
Life at rated load, cos φ = 0.6	> 4x10 <sup>4</sup>	> 4x10 <sup>4</sup>
Max. operating cycles	10 <sup>3</sup> /h	10 <sup>3</sup> /h
Maximum conductor cross-section (3-fold terminal)	6 mm <sup>2</sup> (4 mm <sup>2</sup> )	4 mm <sup>2</sup>
Two conductors of same cross-section (3-fold terminal)	2.5 mm <sup>2</sup> (1.5 mm <sup>2</sup> )	1.5 mm <sup>2</sup>
Screw head	slotted/crosshead, pozidriv	slotted/crosshead
Type of enclosure/terminals	IP50/IP20	IP30/IP20
<b>Electronics</b>		
Time on	100%	100%
Max./min. temperature at mounting location	+50°C/-20°C	+50°C/-20°C
Standby loss (activ power)	0.5 W	0.7 W
Control current local at 230 V (<10 s) ± 20%	2 mA	1 mA
Control current universal control voltage 8/12/24/230 V (<10 s) ± 20%	2/4/9/5(100) mA	2/4/9/5(100) mA
Max. parallel capacitance (approx. length) of individual control lead at 230 V AC	0,06 μF (200 m) C1/C2: 0.9 μF (3000 m)	0.06 μF (200 m) A1-A2: 0.3 μF (1000 m)

\* EVG = electronic ballast units; KVG = conventional ballast units

<sup>b)</sup> Bistable relay as relay contact. The switched consumer may not be connected to the mains before the short automatic synchronisation after installation has terminated.

To comply with DIN VDE 0100-443 and DIN VDE 0100-534, a Type 2 or Type 3 surge protection device (SPD) must be installed.