



Time relays, Multifunctions time relay and timer.
Up to 18 functions combined with universal control
voltage – an unrivalled combination.

13



Time relays, multifunction time relays and timer







| | |
|---|-------|
| Selection table time relays and multifunction time relays | 13-2 |
| Digital settable multifunction time relay MFZ12DDX with 18 functions | 13-3 |
| Analogue settable multifunction time relay MFZ12DX with 18 functions | 13-4 |
| Analogue settable time relays RVZ/AVZ/TGI/EAW | 13-5 |
| Analogue settable multifunction time relay MFZ12NP with 10 functions | 13-6 |
| Analogue settable multifunction time relay MFZ12-230V with 10 functions | 13-7 |
| Analogue settable 2-stage ON-delay A2Z12 | 13-8 |
| Fully electronic multifunction time relay MFZ12PMD with 18 functions | 13-9 |
| Analogue settable multifunction time relay MFZ61DX | 13-10 |
| Test Pushbutton for emergency lighting with off-delay PTN12 | 13-10 |
| Description of functions of the time relays and multifunction time relays | 13-11 |
| Digital settable timer with 2 channels S2U12DDX | 13-12 |
| Technical data time relays, multifunction time relays and timer | 13-13 |

Selection Table

Time Relays and Multifunction Time Relays

The successful

Multifunction time relays with up to 18 functions combined with universal control voltage 8 to 230V UC - a competitive advantage, particularly the digital settable time relays MFZ12DDX. Multifunction time relays always switch at zero passage, the DX devices only when connected to N.

| Page | 13-3 | 13-4 | 13-5 | 13-5 | 13-5 | 13-5 | 13-6 | 13-7 | 13-8 | 13-9 | 13-10 | 13-10 | 13-12 |
|---|-----------------|-----------------|-----------------|-----------------|-----------------|-----------------|-----------------|-----------------|-----------------|-------------------|-----------------|-----------------|-----------------|
|  | | | | | | | | | | | | | |
| pictograms | | | | | | | | | | | | | |
| | | | | | | | | | | | | | |
| Modular device for mounting on DIN rail EN 60715 TH35, number of modules 18mm each | 1 | 1 | 1 | 1 | 1 | 1 | 1 | 1 | 1 | 1 | 1 | 1 | 1 |
| Built-in device for installation (e.g. flush-mounting box) | | | | | | | | | | | | ■ | |
| Digital settable | ■ | | | | | | | | | | ■ | | ■ |
| Analogue settable | | ■ | ■ | ■ | ■ | ■ | ■ | ■ | ■ | ■ | | ■ | ■ |
| Number of NO contacts (not potential free) | | | | | | | | (1) | 1 | 1+1 | (1) | 1 | 1+1 |
| Number of CO contacts potential free | 1 | 1 | 1 | 1 | 1 | 1 | | | | | | (1) | |
| Zero passage switching  | ■ ³⁾ | ■ ³⁾ | ■ ³⁾ | ■ ³⁾ | ■ ³⁾ | ■ ³⁾ | ■ ³⁾ | ■ | | | ■ | ■ ³⁾ | ■ ³⁾ |
| Switching capacity 16A/250V AC | | | | | | | ■ | | | | | ■ | ■ |
| Switching capacity 10A/250V AC | ■ | ■ | ■ | ■ | ■ | ■ | | ■ | ■ | | ■ | | |
| Incandescent lamp load W  | 2000 | 2000 | 2000 | 2000 | 2000 | 2000 | 2300 | 1000 | 1000 | 400 ¹⁾ | 2000 | 2300 | 2000 |
| Bistable relay as relay contact  | ■ ²⁾ | ■ ²⁾ | ■ ²⁾ | ■ ²⁾ | ■ ²⁾ | ■ ²⁾ | | ■ ²⁾ | ■ ²⁾ | | ■ ²⁾ | | ■ ²⁾ |
| Universal control voltage  | ■ | ■ | ■ | ■ | ■ | ■ | ■ | | ■ | ■ | ■ | ■ | ■ |
| Low standby loss  | ■ | ■ | ■ | ■ | ■ | ■ | | ■ | ■ | ■ | ■ | ■ | ■ |
| Multifunction time relay | ■ | ■ | | | | | ■ | ■ | | ■ | ■ | | |
| Off delay RV | ■ | ■ | ■ | | | | ■ | ■ | | ■ | ■ | ■ | |
| Operate delay AV | ■ | ■ | | ■ | | | ■ | ■ | | ■ | ■ | | |
| Additive operate delay AV+ | ■ | ■ | | | | | | | | ■ | | | |
| 2-stage ON-delay | | | | | | | | | ■ | | | | |
| Fleeting NO contact EW | ■ | ■ | | | | ■ | ■ | ■ | | ■ | ■ | | |
| Fleeting NC contact AW | ■ | ■ | | | | ■ | ■ | ■ | | ■ | ■ | | |
| Fleeting NO contact and fleeting NC contact EAW | ■ | ■ | | | | ■ | | | | ■ | | | |
| Operate and release delay ARV | ■ | ■ | | | | | ■ | ■ | | ■ | | | |
| Additive operate and release delay ARV+ | ■ | ■ | | | | | | | | ■ | | | |
| Relay function ER | ■ | ■ | | | | | | | | ■ | | | |
| Release-delay impulse switch SRV | ■ | ■ | | | | | | | | ■ | | | |
| Impulse switch functions ES and ESV | ■ | ■ | | | | | | | | ■ | | | |
| Clock generator starting with impulse TI | ■ | ■ | | | ■ | | ■ | ■ | | ■ | ■ | | |
| Clock generator starting with pause TP | ■ | ■ | | | | | ■ | ■ | | ■ | | | |
| Impulse controlled operate delay IA (e.g. automatic door opener) | ■ | ■ | | | | | ■ | ■ | | ■ | ■ | | |
| Pulse shaper IF | ■ | ■ | | | | | | | | ■ | | | |

¹⁾ Up to 3400W with capacity enhancers LUD12-230V. ²⁾ The switched consumer may not be connected to the mains before the short automatic synchronisation after installation has terminated. ³⁾ Duplex technology: When switched with 230V/50Hz zero passage switching is activated if L is connected to (L) and N to (N). Then additional standby loss of only 0.1 watt.

Digital settable Multifunction Time Relay MFZ12DDX with 18 functions



MFZ12DDX-UC



**1 CO contact potential free 10A/250VAC. Incandescent lamps 2000W*.
Standby loss 0.05–0.5 watt only.**

Modular device for DIN-EN 60715 TH35 rail mounting.
1 module = 18mm wide, 58mm deep.

With the patented Eltako Duplex technology (DX) the normally potential-free contacts can still switch in zero passage when switching 230V AC 50Hz and therefore drastically reduce wear. Simply connect the neutral conductor to the terminal (N) and L to 15 (L) for this. This gives an additional standby consumption of only 0.1 Watt.

Universal control voltage 8 to 230V UC. Supply voltage same as the control voltage.

Both functions and times are entered at the touch of a key and indicated digitally on an LC display. Only two keys are required for this purpose.

When setting the time all values can be entered within preset time ranges (0.1 to 9.9 or 1 to 99 seconds, minutes or hours). The longest possible setting is 99 hours. 600 settings are possible. The time setting is continuously displayed digitally.

By using a bistable relay coil power loss and heating is avoided even in the on mode.

The switched consumer may not be connected to the mains before the short automatic synchronisation after installation has terminated.

Functions (description page 13-11)

RV = off delay

AV = operate delay

AV+ = operate delay additive

TI = clock generator starting with impulse

TP = clock generator starting with pause

IA = impulse controlled pickup delay (e.g. automatic door opener)

IF = pulse shaper

EW = fleeting NO contact

AW = fleeting NC contact

EAW = fleeting NO contact and fleeting NC contact

ARV = operate and release delay

ARV+ = operate and release delay additive

ES = impulse switch

SRV = release-delay impulse switch

ESV = impulse switch with release delay and switch-off early-warning function

ER = relay

ON = permanent ON

OFF = permanent OFF

With TI, TP, IA, EAW, ARV and ARV+ functions, a different second time can be entered also with different time ranges.

Setting the times and functions: The LCD component to be changed is selected by pressing the MODE key. The component accessed flashes. Press the SET key to change the component accessed. This may be the function, the time ranges, time T1 or time T2 (on TI, TP, IA, EAW, ARV and ARV+ only). Pressing the MODE key terminates each input. Once the time has been set with MODE, no more components are flashing. The timing relay is now ready to operate. Press the MODE key again to restart the input cycle. All the entered parameters are retained if they are not changed using SET. 25 sec. after the last operation and if the component still flashes the input cycle is automatically terminated and the previously made changes lapse.

Functions of the LC display: If the ON or OFF function was selected, no time is displayed, only ON and OFF and a contact symbol in the correct position. On all other functions, the set time, the function code and the contact symbol are shown in the correct position (open or closed). The clock symbol flashes while the set time is elapsing and the remaining time is shown.

Safety in the event of a power failure: The set parameters are stored in an EEPROM and are therefore immediately available again when the power supply is restored after a power failure.

* The maximum load can be used starting at a delay time or clock cycle of 5 minutes. The maximum load will be reduced for shorter times as follows: up to 2 seconds 15 %, up to 2 minutes 30 %, up to 5 minutes 60 %.

Typical connection

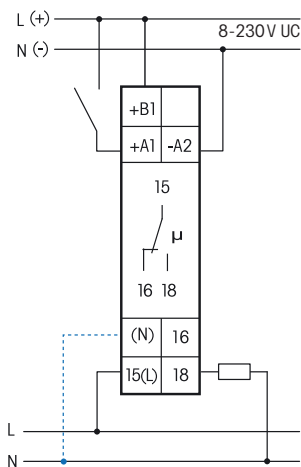

If N is connected, the zero passage switching is active.

Technical data page 13-13.

Housing for operating instructions GBA12, see accessoires, chapter Z.

MFZ12DDX-UC 1 CO 16A

EAN 4010312603079

57,90 €/pc.

Analogue settable Multifunction Time Relay MFZ12DX with 18 functions

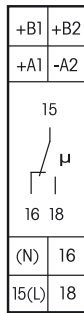

MFZ12DX-UC



**1 CO contact potential free 10A/250V AC. Incandescent lamps 2000W*.
Standby loss 0.02–0.6 watt only.**

Modular device for DIN-EN 60715 TH35 rail mounting.
1 module = 18mm wide, 58mm deep.

With the patented Eltako Duplex technology (DX) the normally potential-free contacts can still switch in zero passage when switching 230V AC 50Hz and therefore drastically reduce wear. Simply connect the neutral conductor to the terminal (N) and L to 15 (L) for this. This gives an additional standby consumption of only 0.1 Watt.

Universal control voltage from 8 to 230V UC. Supply voltage same as control voltage.
Time setting between 0.1 second and 40 hours.

By using a bistable relay coil power loss and heating is avoided even in the on mode.

The switched consumer may not be connected to the mains before the short automatic synchronisation after installation has terminated.

According to the connection of the power supply to the terminals B1-A2 or B2-A2 **two different levels of settings** can be selected:

Functions F with connection of the power supply to B1-A2 (description page 13-11)
(Standby loss 0.02-0.4W)

- RV** = off delay
- AV** = operate delay
- TI** = clock generator starting with impulse
- TP** = clock generator starting with pause
- IA** = impulse controlled operate delay (e.g. automatic door opener)
- EW** = fleeting NO contact
- AW** = fleeting NC contact
- ARV** = operate and release delay
- ON** = permanent ON
- OFF** = permanent OFF

Functions (F) with connection of the power supply to B2-A2 (description page 13-11)
(Standby loss 0.02-0.6W)

- SRV** = release-delay impulse switch
- ER** = relay
- EAW** = fleeting NO contact and fleeting NC contact
- ES** = impulse switch
- IF** = pulse shaper
- ARV+** = additive operate and release delay
- ESV** = impulse switch with release delay and switch-off early-warning function
- AV+** = additive operate delay
- ON** = permanent ON
- OFF** = permanent OFF

The LED below the big rotary switch indicates the contact position while time-out is in progress. It blinks while the relay contact 15-18 is open (15-16 closed), and is continuously ON as long as the relay contact 15-18 is closed (15-16 open).

The time base T is selected by means of the middle, latching rotary switch **T**. Time-base figures available are 0.1 seconds, 0.5 seconds, 2 seconds, 5 seconds, 1 minute, 2 minutes, 5 minutes, 1 hour, 2 hours and 4 hours. The total time is obtained by multiplying the timebase by the multiplier.

The multiplier xT is set on the upper, latching rotary switch **xT** and is in the range from 1 to 10. Thus, time settings can be selected in the range from 0.1 second (time base 0.1 second and multiplier 1) and 40 hours (time base 4 hours and multiplier 10).

* The maximum load can be used starting at a delay time or clock cycle of 5 minutes.
The maximum load will be reduced for shorter times as follows: up to 2 seconds 15%, up to 2 minutes 30%, up to 5 minutes 60%.

Function rotary switches

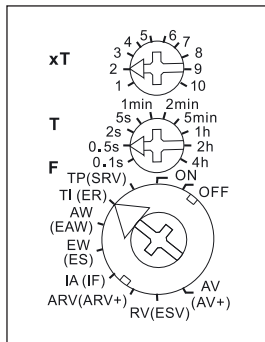

Typical connection Level of setting 1, Functions F

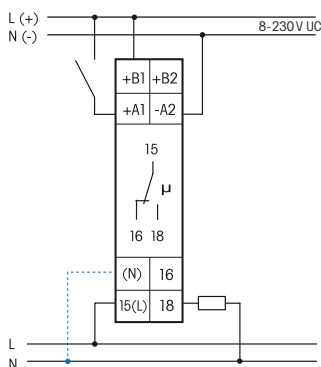

Typical connection Level of setting 2, Functions (F)

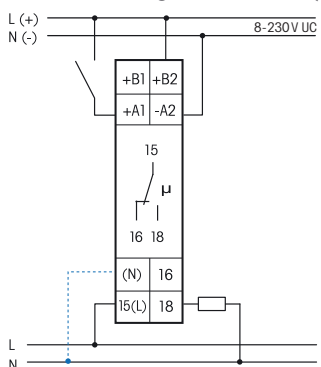

If N is connected, the zero passage switching is active.

Technical data page 13-13.

Housing for operating instructions
GBA12, see accessoires, chapter Z.

MFZ12DX-UC 1 CO 10A

EAN 4010312603086

57,90 €/pc.

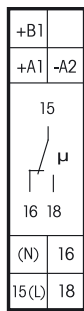

RVZ/AVZ/ TGI/ EAW12DX-UC



1 CO contact potential free 10A/250V AC. Incandescent lamps 2000W*.
Standby loss 0.02–0.4 watt only.

Modular device for DIN EN 60715 TH35 rail mounting.
 1 module = 18mm wide, 58mm deep.

These digital settable time relays are identical to the MFZ12DX-UC, except that they have one function only (description page 13-11).

On type TGI12DX-UC T1 and T2 can be set separately by a second multiplier while the time base remains the same.

On type EAW12DX-UC different functions can be selected by a rotary switch: fleeting NO contact (EW), fleeting NC contact (AW) or fleeting NO contact and fleeting NC contact (EAW).

With the patented Eltako Duplex technology (DX) the normally potential-free contacts can still switch in zero passage when switching 230V AC 50Hz and therefore drastically reduce wear. Simply connect the neutral conductor to the terminal (N) and L to 15 (L) for this. This gives an additional standby consumption of only 0.1 Watt.

Universal control voltage from 8 to 230V UC. Supply voltage like control voltage.

Time setting between 0.1 second and 40 hours.

By using a bistable relay coil power loss and heating is avoided even in the on mode.

The switched consumer may not be connected to the mains before the short automatic synchronisation after installation has terminated.

The LED below the big rotary switch indicates the contact position while time-out is in progress. It blinks while the relay contact 15-18 is open (15-16 closed), and is continuously ON as long as the relay contact 15-18 is closed (15-16 open).

The time base T is selected by means of the middle, latching rotary switch **T**. Time-base figures available are 0.1 seconds, 0.5 seconds, 2 seconds, 5 seconds, 1 minute, 2 minutes, 5 minutes, 1 hour, 2 hours and 4 hours. The total time is obtained by multiplying the time base by the multiplier.

The multiplier xT is set on the upper, latching rotary switch **xT** and is in the range from 1 to 10. Thus, time settings can be selected in the range from 0.1 second (time base 0.1 second and multiplier 1) and 40 hours (time base 4 hours and multiplier 10).

Typical connection

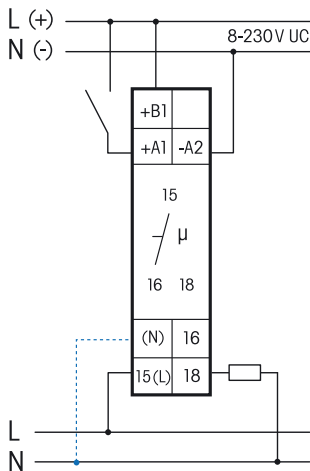

If N is connected, the zero passage switching is active.

* The maximum load can be used starting at a delay time or clock cycle of 5 minutes.
 The maximum load will be reduced for shorter times as follows: up to 2 seconds 15%, up to 2 minutes 30%, up to 5 minutes 60%.

Function rotary switches

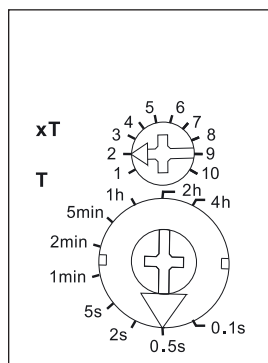

Function rotary switches

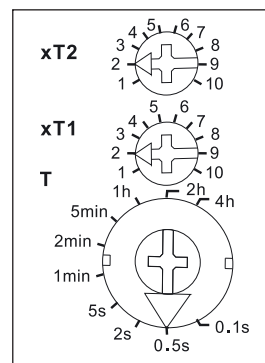

Function rotary switches

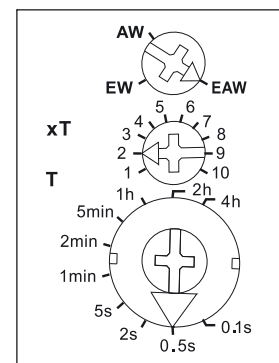

| | | | |
|-------------------|--|-------------------|--------------------|
| RVZ12DX-UC | RV release delay (OFF delay) | EAN 4010312603093 | 50,40 €/pc. |
| AVZ12DX-UC | AV operate delay (ON delay) | EAN 4010312603109 | 50,40 €/pc. |
| TGI12DX-UC | T1 clock generator starting with impulse (flasher relay) | EAN 4010312603116 | 50,40 €/pc. |
| EAW12DX-UC | EW+AW+EAW – fleeting NO contact and fleeting NC contact | EAN 4010312603123 | 50,40 €/pc. |

Technical data page 13-13.
 Housing for operating instructions
 GBA12, see accessoires, chapter Z.

Analogue settable Multifunction Time Relay MFZ12NP with 10 functions

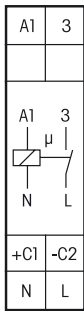

MFZ12NP-230 V+UC



1 NO contact not potential free 16A/250V AC. Incandescent lamps 2300W*. Standby loss 0.5 watt only.

Modular device for DIN EN 60715 TH35 rail mounting.
1 module = 18mm wide, 58mm deep.

Zero passage switching to protect contacts and lamps.

This prolongs in particular the lifetime of energy saving lamps.

State-of-the-art hybrid technology combines advantages of nonwearing electronic control with high capacity of special relays.

230V control voltage and additionally 8 to 230V UC electrically isolated universal control voltage. 230V supply voltage and switching voltage.

Very low switching noise.

Time settings between 0.1 seconds and 40 hours.

Functions F (description page 13-11)

RV = release delay

AV = operate delay

TI = clock generator starting with impulse

TP = clock generator starting with pause

IA = impulse-controlled operate delay

EW = fleeting NO contact

AW = fleeting NC contact

ARV = operate and release delay

ON = permanent ON

OFF = permanent OFF

The LED below the upper function rotary switch informs about the position of the contact during the countdown. It blinks while the contact is open and stays on as long as the contact is closed.

The time base T is selected by means of the middle, latching rotary switch **T**. Time-base figures available are 0.1 second, 0.5 seconds, 2 seconds, 5 seconds, 1 minute, 2 minutes, 5 minutes, 1 hour, 2 hours and 4 hours. The total time is obtained by multiplying the time base by the multiplier.

The multiplier xT is set on the upper, latching rotary switch **xT** and is in the range from 1 to 10. Thus, time settings can be selected in the range from 0.1 second (time base 0.1 second and multiplier 1) and 40 hours (time base 4 hours and multiplier 10).

* The maximum load can be used starting at a delay time or clock cycle of 5 minutes. The maximum load will be reduced for shorter times as follows: up to 2 seconds 15%, up to 2 minutes 30%, up to 5 minutes 60%.

Function rotary switches

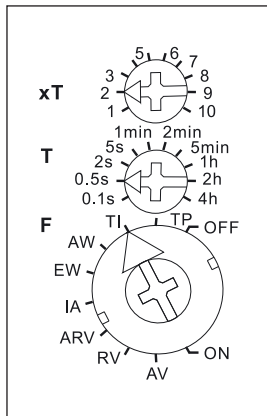

Standard setting ex works.

13-6

Typical connection

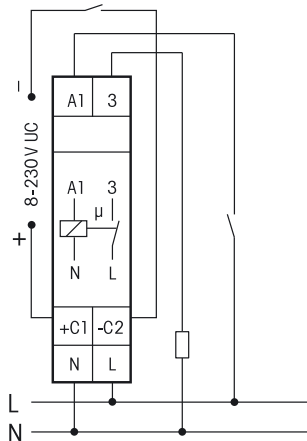

Technical data page 13-13.

Housing for operating instructions GBA12, see accessoires, chapter Z.

MFZ12NP-230V+UC

1 NO 16A

EAN 4010312602935

46,70 €/pc.

Analogue settable Multifunction Time Relay MFZ12-230V with 10 functions



MFZ12-230 V



**1 NO contact potential free 10A/250V AC. Incandescent lamps 1000W*.
Standby loss 0.4 watt only.**

Modular device for DIN-EN 60715 TH35 rail mounting.
1 module = 18mm wide, 58mm deep.

Control voltage 230V. Supply voltage same as control voltage.

Time setting between 0.1 second and 40 hours.

Functions F (description page 13-11)

RV = off delay

AV = operate delay

TI = clock generator starting with impulse

TP = clock generator starting with pause

IA = impulse controlled operate delay (e.g. automatic door opener)

EW = fleeting NO contact

AW = fleeting NC contact

ARV = operate and release delay

ON = permanent ON

OFF = permanent OFF

The LED below the big rotary switch indicates the contact position while time-out is in progress. It blinks while the relay contact is open, and is continuously ON as long as the relay contact is closed.

The time base T is selected by means of the middle, latching rotary switch **T**. Time-base figures available are 0.1 seconds, 0.5 seconds, 2 seconds, 5 seconds, 1 minute, 2 minutes, 5 minutes, 1 hour, 2 hours and 4 hours. The total time is obtained by multiplying the timebase by the multiplier.

The multiplier xT is set on the upper, latching rotary switch **xT** and is in the range from 1 to 10. Thus, time settings can be selected in the range from 0.1 second (time base 0.1 second and multiplier 1) and 40 hours (time base 4 hours and multiplier 10).

* The maximum load can be used starting at a delay time or clock cycle of 5 minutes. The maximum load will be reduced for shorter times as follows: up to 2 seconds 15%, up to 2 minutes 30%, up to 5 minutes 60%.

Function rotary switches

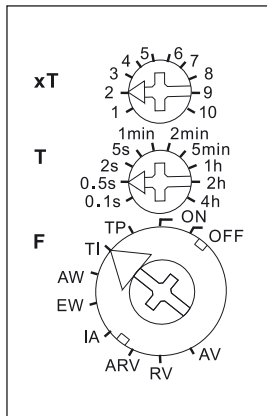

Standard setting ex works.

Typical connection

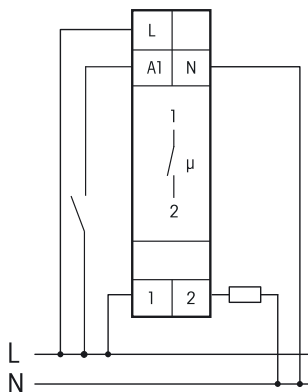

Technical data page 13-13.

Housing for operating instructions GBA12, see accessoires, chapter Z.

MFZ12-230V 1 NO 10A

EAN 4010312603147

44,00 €/pc.

Analogue settable 2-stage ON-delay A2Z12



A2Z12-UC



1+1 NO contact potential free 10A/250V AC. Incandescent lamps 1000 W. Standby loss 0.4 watt only.

Modular device for DIN EN 60715 TH35 rail mounting.

1 module = 18mm wide, 58mm deep.

State-of-the-art hybrid technology combines advantages of nonwearing electronic control with high capacity of special relays.

Universal control voltage input 8 to 230V UC. Supply voltage is same as the control voltage.

Contact position display with two LEDs.

By using a bistable relay coil power loss and heating is avoided even in the on mode.

The switched consumer may not be connected to the mains before the short automatic synchronisation after installation has terminated.

In case of a power failure the system is disconnected in a preset sequence.

When the control voltage is applied, the time lapse T1 starts between 0 and 60 seconds.

At the end of the time lapse, contact 1-2 closes and time lapse T2 starts between 0 and 60 seconds. At the end of this time lapse, contact 3-4 closes. After an interval, the time lapse starts again at T1.

Function rotary switches

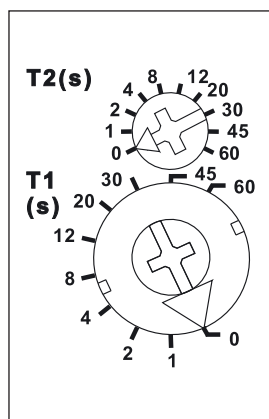

Standard setting ex factory.

13-8

Typical connection

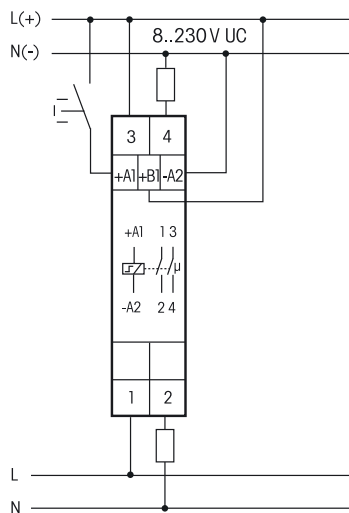

Technical data page 13-13.

Housing for operating instructions GBA12, see accessoires, chapter Z.

A2Z12-UC

1 + 1 NO 16A

EAN 4010312603178

60,70 €/pc.

Fully Electronic Multifunction Time Relay MFZ12PMD with 18 functions

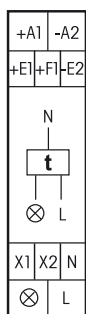

MFZ12PMD-UC



Power MOSFET with almost unlimited number of circuits up to 400W. Automatic lamp detection. Standby loss 0.3 watt only. Dim down to minimum brightness and up to maximum brightness and Soft ON / Soft OFF are also adjustable for lamp circuit.

Modular device for DIN EN 60715 TH35 rail mounting.
1 module = 18mm wide, 58mm deep.

Digitally adjustable and fully electronic multifunction time relay for lamps up to 400W dependent on ventilation conditions. Dimmable energy saving lamps (ESL) and dimmable 230V LED lamps are also dependent on the lamp electronics.

If **minimum brightness** is not set to 0, the circuit is not switched off but dimmed down to the set percentage.

Up to 3600W with capacity enhancers LUD12-230V (description page 9-7) at the terminals X1 and X2. Universal control voltage 8 to 230V UC and additionally the universal voltage control inputs 8 to 230V UC central ON and central OFF. The control inputs are electrically isolated from the supply voltage and switching voltage.

Zero passage switching to protect lamps.

Glow lamp current up to 5mA starting at 110V.

Automatic electronic overload protection and overtemperature switch-off.

Enter both the functions and the times using the two buttons MODE and SET. The functions and times are indicated digitally on an LC display. The time can be set by entering all values within the preselected time scale (0.1 to 9.9 or 1 to 99 seconds, minutes or hours). The longest time is 99 hours. This permits 600 time settings. The time(s) entered is (are) permanently displayed digitally.

Settable functions (description page 13-11): **RV** = release delay, **AV** = operate delay, **AV+** = additive operate delay, **TI** = clock generator starting with impulse, **TP** = clock generator starting with pause, **IA** = impulse-controlled operate delay, **IF** = pulse shaper, **EW** = fleeting NO contact, **AW** = fleeting NC contact, **EAW** = fleeting NO contact and fleeting NC contact, **ARV** = operate and release delay, **ARV+** = additive operate and release delay, **ES** = impulse switch, **SRV** = release delay impulse switch, **ESV** = impulse switch with release delay and switch-off early-warning function, **ER** = relay, **ON** = permanent ON, **OFF** = permanent OFF. With TI, TP, IA, EAW, ARV and ARV+ functions, a different second time can be entered also with different time ranges.

Setting the times and functions: The LCD component to be changed is selected by pressing the MODE key. The component accessed flashes. Press the SET key to change the component accessed. This may be the function, the time ranges, time T1 or time T2 (on TI, TP, IA, EAW, ARV and ARV+ only). Pressing the MODE key terminates each input. Once the time has been set with MODE, no more components are flashing. The timing relay is now ready to operate. Press the MODE key again to restart the input cycle. All the entered parameters are retained if they are not changed using SET. 25 sec. after the last operation and if the component still flashes the input cycle is automatically terminated and the previously made changes lapse.

Setting additional parameters valid for all functions: when you press the MODE button for longer than 2 seconds, you access the submenu. Press the SET button to select the parameter you want to change. Then confirm by pressing MODE. Press SET to enter the parameter and confirm by pressing MODE. After the 'LED' submenu, you return automatically to the main menu.

MIN = Minimum brightness in OFF state settable to 0 and from 10 to 89(%), factory setting = 0.

MAX = Maximal brightness in ON state settable from 10 to 99(%), factory setting = 99. MAX must be at least 10 divisions above MIN.

RMP = Switch ON/OFF ramp (soft ON and soft ON) adjustable from 0 = 10ms to 99 = 1s, factory setting = 0.

LED = LED+ for dimmable 230V LED lamps which cannot be dimmed down far enough in automatic mode (trailing edge control) for design reasons and must therefore be forced by phase control. Enabled by pressing MODE; factory setting = LED without +.

Functions of the LC display: if you selected the functions ON or OFF, no time is displayed. Instead an arrow indicates either ON or OFF. In all other functions the set time(s), the function abbreviation and an arrow next to ON and OFF display the switching position. The clock symbol flashes while the set time is elapsing and the remaining time is shown.

Safety in the event of a power failure: The set parameters are stored in an EEPROM and are therefore immediately available again when the power supply is restored after a power failure.

Technical data page 13-13.

Housing for operating instructions
GBA12, see accessoires, chapter Z.

MFZ12PMD-UC Power MOSFET up to 400W

EAN 4010312601099

69,00 €/pc.

Analogue settable Multifunction Time Relay MFZ61DX

Test Pushbutton for Emergency Lighting Systems with Off-delay PTN12

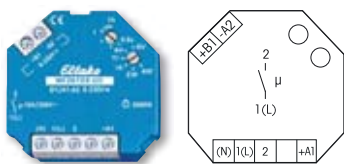

Function rotary switches

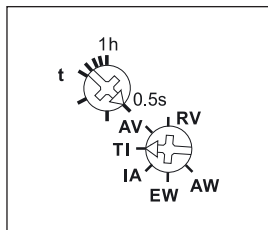

Standard setting ex factory.

Typical connection

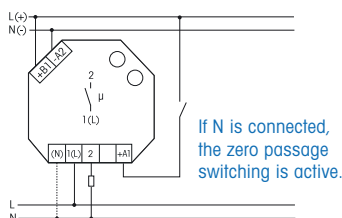

MFZ61DX-UC



1 NO contact potential free 10A/250V AC. Incandescent lamps 2000W*. Standby loss 0.02–0.4 watt only.

Built-in device for installation. 45 mm long, 45 mm wide, 18 mm deep.

With the patented **Eltako Duplex technology (DX)** the normally potential-free contacts can still switch in zero passage when switching 230V AC 50Hz and therefore drastically reduce wear. Simply connect the neutral conductor to the terminal (N) and L to 1 (L) for this. This gives an additional standby consumption of only 0.1 watt.

State-of-the-art hybrid technology combines advantages of nonwearing electronic control with high capacity of special relays.

By using a bistable relay coil power loss and heating is avoided even in the on mode.

The switched consumer may not be connected to the mains before the short automatic synchronisation after installation has terminated.

Universal control voltage input 8 to 230V UC. Supply voltage is same as the control voltage.

Time settings between 0.5 seconds and 1 hour.

Functions F (description page 13-11)

- RV** = off delay
- AV** = operating delay
- TI** = clock generator starting with impulse
- IA** = impulse-controlled operating delay
- EW** = fleeting NO contact
- AW** = fleeting NC contact

* The maximum load can be used from a delay time or clock cycle of 5 minutes. The maximum load is reduced for shorter times as follows: up to 2 seconds 15%, up to 2 minutes 30%, up to 5 minutes 60%.

| | | | |
|-------------------|----------|-------------------|--------------------|
| MFZ61DX-UC | 1 NO 10A | EAN 4010312603055 | 42,80 €/pc. |
|-------------------|----------|-------------------|--------------------|

13-10

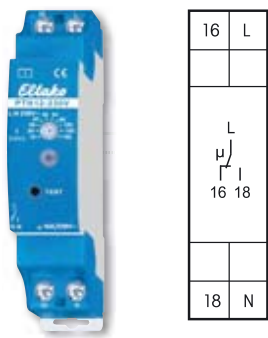

Function rotary switch

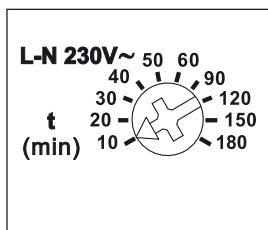

Standard setting ex works.

PTN12-230V



Test pushbutton for emergency lighting systems with its own battery supply. 1 CO contact 16A/250V AC. Off-delay settable between 10 and 180 minutes. Only 0.5 watt standby loss.

Modular device for DIN-EN 60715 TH35 rail mounting. 1 module = 18 mm wide, 58 mm deep. Supply voltage 230V, 50/60Hz.

Off-delay 10, 20, 30, 40, 50, 60, 90, 120, 150 and 180 minutes settable with rotary switch.

When the supply voltage is applied, the green LED lights up.

For further informations see the operating instructions.

Typical connections

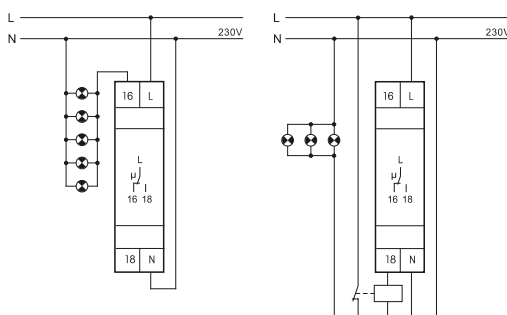

Direct control of the emergency light systems $I \leq 16A$
 ⚡ Emergency light systems with own battery supply

Control of emergency light systems via electric contactor $I > 16A$
 ⚡ Emergency light systems with own battery supply

Technical data page 13-13.

Housing for operating instructions GBA12, see accessoires, chapter Z.

| | | | |
|-------------------|------------------|-------------------|--------------------|
| PTN12-230V | 1 CO contact 16A | EAN 4010312603215 | 49,00 €/pc. |
|-------------------|------------------|-------------------|--------------------|

The contact 15-18 corresponds on MFZ12NP to the contact L-3. The terminals A1-A2 correspond on MFZ12NP to the terminals A1-N or C1-C2.
 The contact 15-18 corresponds on MFZ61DX and MFZ12-230V to the contact 1-2. The terminals A1-A2 correspond on MFZ12-230V to the terminals A1-N.
 The contact 15-18 corresponds on MFZ12PMD to the output ⊗.

RV = Release delay

(OFF delay)



When the control voltage is applied the relay contact switches to 15-18. When the control voltage is interrupted the timing period is started; on time-out the relay contact returns to normal position. Resettable during the timing period.

AV = Operate delay

(ON delay)

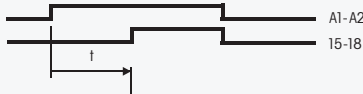

When the control voltage is applied the timing period is started; on time-out the relay contact changes to 15-18. After an interruption, the timing period is restarted.

TI = Clock generator starting with impulse

(flasher relay)

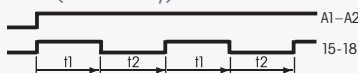

As long as the control voltage is applied the relay contact opens and closes. On MFZ12, MFZ12DX, MFZ12NP and MFZ61DX the changeover time in both directions is identical, and is equal to the preset time. On TG12DX both times can be set separately (identical time base, but additional multiplier), on MFZ12DDX and MFZ12PMD it is completely settable separately. When the control voltage is applied the relay contact immediately changes to 15-18.

TP = Clock generator starting with pause (flasher relay)

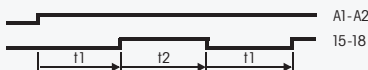

Description of function same as for TI, except that, when the control voltage is applied, the contact initially remains at 15-16 rather than changing to 15-18.

IA = Impulse-controlled operate delay

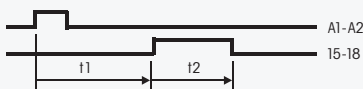

The timing period t_1 starts with a control impulse from 50ms; on time-out the relay contact changes for the timing period t_2 (for MFZ12 and MFZ12DX = 1 second, for MFZ12NP and MFZ61DX = 3 seconds) to 15-18 for 1 second (e.g. for automatic door opener). If t_1 is set to $t_1 \text{ min} = 0.1$ seconds, the IA operates as pulse shaper, when timing period t_2 elapses, independent of the duration of the control impulse (min. 150ms).

EW = Fleeting NO contact



When the control voltage is applied the NO contact changes to 15-18 and reverts on wiping time-out. If the control voltage is removed during the wiping time the NO contact immediately reverts to 15-16 and the residual time is cancelled.

AW = Fleeting NC contact



When the control voltage is interrupted the NO contact changes to 15-18, and reverts on wiping time-out. If the control voltage is applied during the wiping time the NO contact immediately reverts to 15-16 and the residual time is cancelled.

ARV = Operate and release delay

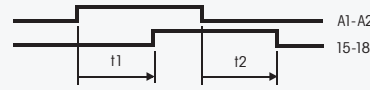

When the control voltage is applied the timing period starts; on time-out the relay contact changes to 15-18. If the control voltage is interrupted then, another timing period is started and, on time-out, the relay contact to normal position. On MFZ12, MFZ12DX and MFZ12NP this release delay is identical to the operating delay, on MFZ12DDX and MFZ12PMD it is completely settable separately. After an interruption of the operating delay, the timing period is restarted.

ER = Relais

As long as the control contact is closed the make contact reverts from 15-16 to 15-18.

EAW = Fleeting NO contact and fleeting NC contact



When the control voltage is applied or interrupted the relay contact changes to 15-18 and reverts after the set wiping time.

ES = Impulse switch

With control impulses from 50ms the make contact switches to and fro.

IF = Pulse shaper



When the control voltage is applied the relay contact changes to 15-18 for the set time. Further control impulses are evaluated only after the set time has elapsed.

ARV+ = Additive operate and release delay

Same function as ARV, but after an interruption of the operate delay the elapsed time is stored.

ESV = Impulse switch with release delay and switch-off early-warning function

Function same as SRV. Additionally with switch-off early warning: approx. 30 sec. before time-out the lighting starts flickering 3 times at gradually shorter time intervals.

AV+ = Additive operate delay

Function same as AV. However, after an interruption the elapsed time is stored.

SRV = Release-delay impulse switch

With control impulses from 50ms the make contact switches to and fro. In the contact position 15-18, the device switches automatically to the rest position 15-16 on delay time-out.

A2 = 2-stage ON-delay

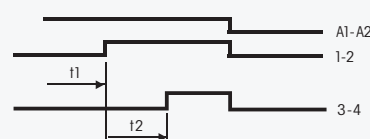

When the control voltage is applied, the time lapse T_1 starts between 0 and 60 seconds. At the end of the time lapse, contact 1-2 closes and time lapse T_2 starts between 0 and 60 seconds. At the end of this time lapse, contact 3-4 closes. After an interval, the time lapse starts again at T_1 .

Digital Settable Timer with 2 Channels

S2U12DDX

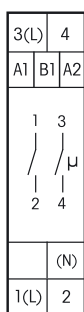

S2U12DDX-UC



2-channel timer. 1+1 NO contacts potential free 16A/250V AC. With 'astro' function. Only 0.03–0.4 watt standby loss.

Modular device for DIN-EN 60715 TH35 rail mounting. 1 module = 18mm wide, 58mm deep. **Patented Eltako Duplex technology (DX) allows you to switch normally potential free contacts in zero passage switching when 230V A/C voltage 50Hz is switched. This drastically reduces wear. To achieve this, simply connect the N conductor to the terminal (N) and L to 1(L) and/or 3(L). This results in an additional standby consumption of only 0.1 watt. In the ON state, the use of bistable relays causes no coil power loss or heating.**

Up to 60 timer memory locations are freely assigned to the channels. With date and automatic summer/winter time changeover. Ca. 7 days power reserve without battery.

Each memory location can be assigned with the astro function (automatic switching after sunrise or sundown), the switch on/off time or a pulsed switching time (which triggers an impulse of 2 seconds). The astro switch on/off time can be changed up to ±2 hours and starting from the production week 19/2012 a time lag of up to ±2 hours influenced by the solstices can be entered additionally.

With control input (+A1) for central control ON or OFF with priority.

Supply voltage and control voltage for central control 8 to 230V UC.

The timer is set using the MODE and SET buttons and a keylock function is provided.

Set language: Every time the power supply is applied, press SET within 10 seconds to set the language and press MODE to confirm. D = German, GB = English, F = French, IT = Italian and ES = Spanish. The normal display then appears: weekday, time, day and month.

Rapid scroll: In the following settings, the numerals scroll rapidly when you press and hold down Enter. Release then press and hold down to change the scroll direction.

Set clock: Press MODE then at PRG (program) press SET to search for the **CLK function**. Press MODE to set. In H, press SET to select the hour and press MODE to confirm. In M proceed in the same way to set the minute.

Set date: Press MODE then at PRG press SET to search for the **DAT function**. Press MODE to select. At Y, press SET to select the year and press MODE to confirm. Proceed in the same way at M to set the month and at D to set the day. The last setting in the sequence is MO (weekday) blinking. Press SET to set it and press MODE to confirm.

Set geographic position (if astro function is required): you can find a list of German cities at the end of the operating manual. Press MODE then press SET at PRG to search for the **POS function**. Select by pressing MODE. Press SET at LAT to select the latitude. Select by pressing MODE. Repeat this procedure for LON to select the longitude and press MODE to confirm. Press SET at GMT to select the time zone and press MODE to confirm. If desired a time lag of up to ± 2 hours can be entered at WS (winter solstice) and SS (summer solstice) for both channels.

Manual switching ON or OFF with priority: Press MODE and for PRG press SET to search for **function INT**. Then press MODE to select. For CH press SET to select channel 1 or 2 and press MODE to confirm. Now you can switch between AUT (automatic) and ON or OFF using SET. After confirming with MODE the shift position of the selected channel may change. If the shift position should change automatically when a time program becomes active, AUT (automatic) should be selected again. If MODE is pressed longer than 2 seconds at confirmations the change is saved and the normal display will appear.

Summer/winter time changeover: Press MODE then at PRG press SET to search for the **SWT function** and press MODE to select. Now press SET to switch between ON and OFF. If you select ON, changeover is automatic.

Central control ON or OFF with priority at automatic mode (AUT): Press MODE and then SET for PRG (program) to search for the **function CIA**. Press MODE to select. Then press SET to switch from CON to COF and press MODE to confirm.

Switch random mode on/off: Press MODE then at PRG press SET to search for the **RND function** and press MODE to select. Press SET to set to ON (RND+) or OFF (RND) and press MODE to confirm. When random mode is switched on, all switch-on time points of all channels are shifted at random by up to 15 minutes. Switch-on times are switched earlier and switch-off times are switched later.

Entering timer programs: refer to the operating instructions.

Enable keylock: Briefly press MODE and SET together and at LCK, press SET to lock. This is displayed by an arrow next to the lock symbol.

Disable keylock: Press MODE and SET together for 2 seconds and at UNL press SET to unlock.

13-12

| | MFZ12DDX^{b)} MFZ12DX^{b)} RVZ/AVZ/TGI/ EAW12DX^{b)} | MFZ12NP PTN12 | MFZ12-230V A2Z12-UC^{b)} | MFZ61DX^{b)} | S2U12DDX^{b)} | MFZ12PMD |
|---|---|---|---|---|---|---|
| Contacts | | | | | | |
| Contact material/contact gap | AgSnO ₂ / 0.5 mm | AgSnO ₂ / 0.5 mm | AgSnO ₂ / 0.5 mm | AgSnO ₂ / 0.5 mm | AgSnO ₂ / 0.5 mm | Power MOSFET |
| Spacing of control connections/contact | 6 mm | 3 mm | 6 mm | 6 mm | 6 mm | 6 mm |
| Spacing of control connections C1-C2/contact | – | 6 mm | – | – | – | – |
| Test voltage control connections/contact | 4000V | 2000V | 4000V | 4000V | 4000V | 4000V |
| Test voltage C1-C2/contact | – | 4000V | – | – | – | – |
| Rated switching capacity | 10 A/250 V AC | 16 A/250 V AC | 10 A/250 V AC | 10 A/250 V AC | 16 A/250 V AC | 400 W |
| Incandescent lamp and halogen lamp load ¹⁾ 230 V, I _{on} ≤ 70 A/10 ms | 2000 W ³⁾ | 2300 W ³⁾ | 1000 W ³⁾ | 2000 W ³⁾ | 2000 W ³⁾ | 400 W |
| Fluorescent lamp load with KVG* in lead-lag circuit or non compensated | 1000 VA ³⁾ | 1000 VA ³⁾ | 500 VA ³⁾ | 1000 VA ³⁾ | 1000 VA ³⁾ | – |
| Fluorescent lamp load with KVG* shunt-compensated or with EVG* | 500 VA ³⁾ | 500 VA ³⁾ | 250 VA ³⁾ | 500 VA ³⁾ | 500 VA ³⁾ | – |
| Compact fluorescent lamps with EVG* and energy saving lamps ESL | 15x7 W 10x20 W ^{3) 4) 5)} | 15x7 W 10x20 W ^{3) 5)} | I _{on} ≤ 35 A/10 ms ^{2) 3) 5)} | 15x7 W 10x20 W ^{3) 4) 5)} | 15x7 W 10x20 W ^{3) 4) 5)} | 100 W ⁵⁾ |
| 230 V LED lamps | up to 200 W ⁵⁾ I _{on} ≤ 120 A/5 ms | up to 200 W ⁵⁾ I _{on} ≤ 30 A/20 ms | up to 200 W ⁵⁾ I _{on} ≤ 120 A/5 ms | up to 200 W ⁵⁾ I _{on} ≤ 120 A/5 ms | up to 200 W ⁵⁾ I _{on} ≤ 120 A/5 ms | – |
| Max. switching current DCI: 12 V/24 V DC | 8 A | – | 8 A | 8 A | 8 A | – |
| Life at rated load, cos φ = 1 for incandescent lamps 1000 W at 100/h | > 10 ⁵ | > 10 ⁵ | > 10 ⁵ | > 10 ⁵ | > 10 ⁵ | ∞ |
| Life at rated load, cos φ = 0.6 at 100/h | > 4 x 10 ⁴ | > 4 x 10 ⁴ | > 4 x 10 ⁴ | > 4 x 10 ⁴ | > 4 x 10 ⁴ | ∞ |
| Maximum conductor cross-section (3-fold terminal) | 6 mm ² (4 mm ²) | 6 mm ² (4 mm ²) | 6 mm ² (4 mm ²) | 4 mm ² | 6 mm ² (4 mm ²) | 6 mm ² (4 mm ²) |
| Two conductors of same cross-section (3-fold terminal) | 2.5 mm ² (1.5 mm ²) | 2.5 mm ² (1.5 mm ²) | 2.5 mm ² (1.5 mm ²) | 1.5 mm ² | 2.5 mm ² (1.5 mm ²) | 2.5 mm ² (1.5 mm ²) |
| Screw head | slotted / cross-head, pozidriv | slotted / cross-head, pozidriv | slotted / cross-head, pozidriv | slotted / cross-head | slotted / cross-head, pozidriv | slotted / cross-head, pozidriv |
| Type of enclosure/terminals | IP50/IP20 | IP50/IP20 | IP50/IP20 | IP30/IP20 | IP50/IP20 | IP50/IP20 |
| Electronics | | | | | | |
| Time on | 100 % | 100 % | 100 % | 100 % | 100 % | 100 % |
| Max./min. temperature at mounting location | +50°C/-20°C | +50°C/-20°C | +50°C/-20°C | +50°C/-20°C | +50°C/-20°C | +50°C/-20°C |
| Temperature dependence | < 0.2 % per °C | < 0.2 % per °C | < 0.2 % per °C | < 0.2 % per °C | < 0.2 % per °C | < 0.2 % per °C |
| Repeat accuracy at 25°C | ±0.1% | ±0.1% | ±0.1% | ±0.1% | ±0.1% | ±0.1% |
| Control voltage dependence from 0.9 to 1.1x rated voltage | none | none | none | none | none | none |
| Stored energy time in the event of power failure (then total reset) | ≥ 0.2 seconds | ≥ 0.2 seconds | ≥ 0.2 seconds | ≥ 0.2 seconds | 7 days | ≥ 0.2 seconds |
| Standby loss (active power) 230V | MFZ12DDX: 0.5W; MFZ12DX: 0.4-0.6 W; RVZ/AVZ/TGI/ EAW12: 0.4 W | 0.5 W | 0.4 W | 0.4 W | 0.4 W | 0.3 W |
| Standby loss (active power) 12V/24V | 0.02 W/0.04 W; MFZ12DDX: 0.05 W/0.1 W | – | – | 0.02 W/0.04 W | 0.03 W/0.06 W | – |
| Control current 230 V-control input local ±20% | – | 2 mA | 2 mA; A2Z12: – | – | – | – |
| Control current universal control voltage 8/12/24/230V (<10s) ± 20% | 0.05/0.1/ 0.2/1 mA | 2/4/9/5 (100) mA | A2Z12: 0.05/ 0.1/0.2/1 mA | 0.05/0.1/ 0.2/1 mA | 0.04/0.05/ 0.1/1.2 mA | 10 (100)mA |
| Max. parallel capacitance (approx. length) of the control leads at 230V AC | 0.2 μF (600 m) | 0.01 μF (30 m) C1-C2: 0.03 μF (100 m) | 0.01 μF (30 m); A2Z12: 0.2 μF (600 m) | 0.2 μF (600 m) | 0.2 μF (600 m) | 0.9 μF (3000 m) |

* EVG = electronic ballast units; KVG = conventional ballast units³⁾ Bistable relay as relay contact. The switched consumer may not be connected to the mains before the short automatic synchronisation after installation has terminated.¹⁾ For lamps with a load of 150W max.²⁾ A 40-fold inrush current must be calculated for electronic ballast devices. For steady loads of 1200W or 600W use the current-limiting relay SBR12 or SBR61. See chapter 14, page 14-8.³⁾ The maximum load can be used from a delay time or clock cycle of 5 minutes. The maximum load is reduced for shorter times as follows: up to 2 seconds 15%, up to 2 minutes 30%, up to 5 minutes 60%.⁴⁾ When using DX types close attention must be paid that zero passage switching is activated!⁵⁾ Usually applies for dimmable energy saving lamps and dimmable 230V LED lamps. Due to differences in the lamps electronics, there may be a restriction on the maximum number of lamps; especially if the connected load is very low (for 5W-LEDs).

To comply with DIN VDE 0100-443 and DIN VDE 0100-534, a Type 2 or Type 3 surge protection device (SPD) must be installed.