

**ER12DX-
ESR12DDX-
ER61-UC**



**SWITCHING AND CONTROL PROFESSIONALS –
ELECTRONIC SWITCHING RELAYS, CONTROL
RELAYS AND COUPLING RELAYS.**







Electronic switching relays, control relays and coupling relays

| | |
|--|----------------|
| Selection table switching relays, control relays and coupling relays | 12 - 2 |
| Switching relay ER12DX-UC | 12 - 3 |
| Switching relay ER12-200-UC and ER12-110-UC | 12 - 4 |
| Switching and control relays ER12-001-UC and ER12-002-UC | 12 - 5 |
| Switching relay ER12SSR-UC | 12 - 6 |
| Impulse switch with integrated relay function ESR12NP-230V+UC | 12 - 7 |
| Digital settable multifunction impulse switch with integrated relay function ESR12DDX-UC | 12 - 8 |
| Coupling relays KR09-12V UC, KR09-24V UC and KR09-230V | 12 - 9 |
| Coupling relay KRW12DX-UC | 12 - 10 |
| Switching relay ER61-230V and impulse switch with integrated relay function ESR61NP-230V+UC | 12 - 11 |
| Multifunction impulse switch with integr. relay function ESR61M-UC | 12 - 12 |
| Noiseless impulse switch with integrated relay function ESR61SSR-230V with solid state relay | 12 - 13 |
| Isolating relays ETR61-230V and ETR61NP-230V | 12 - 14 |
| Isolating relay ETR61NP-230V with window contact FK and window contact FK | 12 - 15 |
| Technical data electronic switching relays, control relays and coupling relays | 12 - 16 |

SWITCHING AND CONTROL PROFESSIONALS

Professional hybrid relays combine the advantages of nonwearing electronic control with high switching capacity of special relays. We also use mainly bistable relays. Thus preventing coil power loss

even in the on mode. This increases energy efficiency and reduces heating in the switch cabinet.

| Page | 12-3 | 12-4 | 12-4 | 12-5 | 12-5 | 12-6 | 12-7 | 12-8 | 12-9 | 12-10 | 12-11 | 12-11 | 12-12 | 12-13 | 12-14 | 12-14 | 12-15 | |
|---|---|-----------------|-----------------|-----------------|-----------------|-----------------|------------|--------------------------------------|-----------------|---------------------------|-----------------|--------------------|--------------------------------------|-----------|---------------|------------|--------------|-----------------|
| | pictograms | ERT2DX-UC | ERT2-200-UC | ERT2-110-UC | ERT2-001-UC | ERT2-002-UC | ERT2SSR-UC | ESR12NP-230V+UC | ESR12DDX-UC | KR09-12V UC, 24V UC, 230V | KRW12DX-UC | ER61-UC | ESR61NP-230V+UC | ESR61M-UC | ESR61SSR-230V | ETR61-230V | ETR61NP-230V | ETR61NP-230V+FK |
| Modular device for mounting on DIN rail EN 60715 TH35, number of modules 18 mm each | 1 | 1 | 1 | 1 | 1 | 1 | 1 | 1 | 1/2 | 1 | | | | | | | | |
| Built-in device for installation (e.g. flush-mounting box) | | | | | | | | | | | | ■ | ■ | ■ | ■ | ■ | ■ | ■ |
| Number NO contacts or changeover contact (W) potential free (not potential free) | 1 | 2 | 1 | 1W | 2W | 1 | (1) | 1+1 ²⁾ 2 ²⁾ | 1 | 1 | 1W | (1) | 1+1 ²⁾ 2 ²⁾ | (1) | 1 | (1) | (1) | |
| Number NC contacts potential free | | | 1 | | | | | 1-2 ²⁾ | | | | 1-2 ²⁾ | | | | | | |
| Zero passage switching |  | ■ ⁷⁾ | | | | | | ■ ⁷⁾ | | ■ ⁷⁾ | | ■ | | ■ | | | | |
| Switching capacity 16 A/250 V AC | ■ | ■ | ■ | ■ | ■ | | ■ | ■ | | ■ | | | | | | | | |
| Switching capacity 10 A/250 V AC | | | | | | | | | 6A | | ■ | ■ | ■ | | ■ | ■ | ■ | |
| Incandescent lamp load W | 2000 | 2000 | 2000 | 2000 | 2000 | 400 | 2300 | 2000 | 500 | 2000 | 2000 | 2000 | 2000 | 400 | 1000 | 2000 | 2000 | |
| Bistable relay(s) as relay contact(s) |  | ■ ⁵⁾ | ■ ⁵⁾ | ■ ⁵⁾ | ■ ⁵⁾ | ■ ⁵⁾ | | ■ ⁶⁾ | | ■ ⁵⁾ | ■ ⁵⁾ | ■ ⁶⁾ | ■ ⁵⁾ | | | | | |
| Switchable between the functions for impulse switches and switching relays | | | | | | | | ■ | ■ | | | ■ | ■ | ■ | | | | |
| Universal control voltage |  | ■ | ■ | ■ | ■ | ■ | ■ | ■ | | ■ | ■ | ■ | ■ | | | | | |
| (additional) control voltage 230 V | | | | | | | | (■) | | | | (■) | | ■ | | | | |
| Supply voltage same as control voltage | | | | | | | | | ■ | | | | | ■ | | | | |
| Supply voltage 230 V | | | | | | | | ■ ³⁾ | | | | ■ | | ■ | ■ | ■ | ■ | |
| No standby loss |  | ■ ⁷⁾ | ■ | ■ | ■ | ■ | | | ■ | ■ ⁷⁾ | ■ | | ■ | | | | | |
| Low standby loss |  | | | | | | | ■ | ■ ⁷⁾ | | | ■ | | ■ | ■ | ■ | ■ | |
| Glow lamp current (mA) at the control input 230 V |  | | | | | | | 150 ¹⁾ | 5 | | | 50 ¹⁽⁴⁾ | | | | | | |

¹⁾ Glow lamp current independent from the ignition voltage.

²⁾ Depends on the set function.

³⁾ If the control voltage is 230 V, but the phase conductor is different from the 230 V supply voltage, the universal voltage control input must be used.

⁴⁾ At the control input .

⁵⁾ The relay contact can be open or closed when putting into operation. It will be synchronised at first operation.

⁶⁾ The switched consumer may not be connected to the mains before the short automatic synchronisation after installation has terminated.

⁷⁾ Patented duplex technology: When switching 230 V/50 Hz the contact switching takes place in the zero passage when L is connected to (L) and N to (N). The standby loss is then 0.1 Watt.

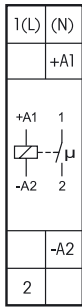

ER12DX-UC



1 NO contact potential free 16 A/250 V AC, incandescent lamp load up to 2000 W. No standby loss.

Modular device for DIN-EN 60715 TH35 rail mounting.

1 module = 18 mm wide, 58 mm deep.

State-of-the-art hybrid technology combines advantages of nonwearing electronic control with high capacity of special relays.

With the patented Eltako Duplex technology (DX) the normally potential-free contacts can still switch in zero passage when switching 230 V AC 50 Hz and therefore drastically reduce wear. Simply connect the neutral conductor to the terminal (N) and L to 1(L) for this. This gives an standby consumption of only 0.1 watt.

If the contact is used for controlling switching devices which do not perform zero passage switching themselves, (N) should not be connected because the additional closing delay otherwise causes the opposite effect.

Universal control voltage 8 to 230 V UC.

Very low switching noise.

Contact position indicator with LED.

Same terminal connection as electromechanical switching relay R12-100-.

By using a bistable relay coil power loss and heating is avoided even in the on mode.

The relay contact can be open or closed when putting into operation. It will be synchronised at first operation.

This relay is not suitable to feed back the switching voltage signal of a dimmer switch.

Use only relays ESR12DDX-UC, ESR12NP-230V+UC or ESR61NP-230V+UC for this purpose.

The electronics does not have an internal power supply and therefore no standby loss. The microcontroller is activated when the control contact closes. This switches the bistable relay to the correct direction. The bistable relay switches back either when the control contact opens or when the control voltage falls.

Typical connection

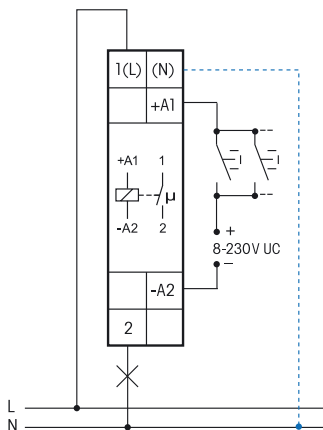

If N is connected, the zero passage switching is active.

Technical data page 12-16.
Housing for operating instructions GBA14,
see accessoires, chapter Z.

| | | | |
|-----------|-------------------|-------------------|-------------|
| ER12DX-UC | 1 NO contact 16 A | EAN 4010312205402 | 42,50 €/pc. |
|-----------|-------------------|-------------------|-------------|

SWITCHING RELAY ER12-200-UC AND ER12-110-UC

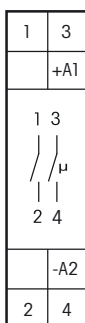

Technical data page 12-16.
Housing for operating instructions GBA14,
see accessoires, chapter Z.

ER12-200-UC



2 NO contacts potential free 16 A/250 V AC, incandescent lamp load up to 2000 W. No standby loss.

Modular device for DIN-EN 60715 TH35 rail mounting. 1 module = 18 mm wide, 58 mm deep.
State-of-the-art hybrid technology combines advantages of nonwearing electronic control with high capacity of special relays.

Universal control voltage 8 to 230 V UC.

Very low switching noise.

Contact position indicator with LED.

Maximum current across both contacts 16 A for 230 V.

Same terminal connection as electromechanical switching relay R12-200-.

By using a bistable relay coil power loss and heating is avoided even in the on mode.

The relay contact can be open or closed when putting into operation. It will be synchronised at first operation.

This relay is not suitable to feed back the switching voltage signal of a dimmer switch.

Use only relays ESR12DDX-UC, ESR12NP-230V+UC or ESR61NP-230V+UC for this purpose.

The electronics does not have an internal power supply and therefore no standby loss.

The microcontroller is activated when the control contact closes. This switches the bistable relay to the correct direction. The bistable relay switches back either when the control contact opens or when the control voltage falls.

| | | | |
|-------------|--------------------|-------------------|-------------|
| ER12-200-UC | 2 NO contacts 16 A | EAN 4010312205433 | 44,00 €/pc. |
|-------------|--------------------|-------------------|-------------|

ER12-110-UC



1 NO + 1 NC contact potential free 16 A/250 V AC, incandescent lamp load up to 2000 W. No standby loss.

Modular device for DIN-EN 60715 TH35 rail mounting. 1 module = 18 mm wide, 58 mm deep.
State-of-the-art hybrid technology combines advantages of nonwearing electronic control with high capacity of special relays.

Universal control voltage 8 to 230 V UC.

Very low switching noise.

Contact position indicator with LED.

Same terminal connection as electromechanical switching relay R12-110-.

By using a bistable relay coil power loss and heating is avoided even in the on mode.

The relay contact can be open or closed when putting into operation. It will be synchronised at first operation.

This relay is not suitable to feed back the switching voltage signal of a dimmer switch.

Use only relays ESR12DDX-UC, ESR12NP-230V+UC or ESR61NP-230V+UC for this purpose.

The electronics does not have an internal power supply and therefore no standby loss.

The microcontroller is activated when the control contact closes. This switches the bistable relay to the correct direction. The bistable relay switches back either when the control contact opens or when the control voltage falls.

| | | | |
|-------------|----------------------------------|-------------------|-------------|
| ER12-110-UC | 1 NO contact + 1 NC contact 16 A | EAN 4010312205440 | 44,00 €/pc. |
|-------------|----------------------------------|-------------------|-------------|

Technical data page 12-16.
Housing for operating instructions GBA14,
see accessoires, chapter Z.



ER12-001-UC



1 CO contact potential free 16 A/250 V AC, incandescent lamp load up to 2000 W. No standby loss.

Modular device for DIN-EN 60715 TH35 rail mounting. 1 module = 18 mm wide, 58 mm deep.
 State-of-the-art hybrid technology combines advantages of nonwearing electronic control with high capacity of special relays. Universal control voltage 8 to 230 V UC.
 Low control power demand, therefore substantially less heat is generated.
 Integrated free-wheeling anti-surge diode (A1 = +, A2 = -).

Safe disconnection to VDE 0106, Part 101; therefore, these devices can also be used as coupling relays. By using a bistable relay coil power loss and heating is avoided even in the on mode.

The relay contact can be open or closed when putting into operation. It will be synchronised at first operation.

This relay is not suitable to feed back the switching voltage signal of a dimmer switch. Use only relays ESR12DDX-UC, ESR12NP-230V+UC or ESR61NP-230V+UC for this purpose.

The electronics does not have an internal power supply and therefore no standby loss.
 The microcontroller is activated when the control contact closes. This switches the bistable relay to the correct direction. The bistable relay switches back either when the control contact opens or when the control voltage falls.

| | | | |
|--------------------|-------------------|-------------------|--------------------|
| ER12-001-UC | 1 CO contact 16 A | EAN 4010312205365 | 42,40 €/pc. |
|--------------------|-------------------|-------------------|--------------------|

Technical data page 12-16.
 Housing for operating instructions GBA14, see accessoires, chapter Z.

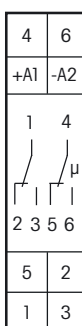

ER12-002-UC



2 CO contacts potential free 16 A/250 V AC, incandescent lamp load up to 2000 W. No standby loss.

Modular device for DIN-EN 60715 TH35 rail mounting. 1 module = 18 mm wide, 58 mm deep.
 State-of-the-art hybrid technology combines advantages of nonwearing electronic control with high capacity of special relays.
 Low switching noise. Contact position indicator with LED.
 Integrated free-wheeling anti-surge diode (A1 = +, A2 = -).

By using a bistable relay coil power loss and heating is avoided even in the on mode.

The relay contact can be open or closed when putting into operation. It will be synchronised at first operation.

This relay is not suitable to feed back the switching voltage signal of a dimmer switch. Use only relays ESR12DDX-UC, ESR12NP-230V+UC or ESR61NP-230V+UC for this purpose.

The electronics does not have an internal power supply and therefore no standby loss.
 The microcontroller is activated when the control contact closes. This switches the bistable relay to the correct direction. The bistable relay switches back either when the control contact opens or when the control voltage falls.

| | | | |
|--------------------|--------------------|-------------------|--------------------|
| ER12-002-UC | 2 CO contacts 16 A | EAN 4010312205372 | 51,20 €/pc. |
|--------------------|--------------------|-------------------|--------------------|

Technical data page 12-16.
 Housing for operating instructions GBA14, see accessoires, chapter Z.

SWITCHING RELAY ER12SSR-UC



ER12SSR-UC



Noiseless solid state relay potential free, 400 Watt. No standby loss.

Modular device for DIN-EN 60715 TH35 rail mounting.

1 module = 18 mm wide, 58 mm deep.

Universal control voltage: 8 to 230 V UC.

Contact position indication with LED.

Switching voltage 230 V AC.

Zero passage switching.

With automatic overtemperature shutdown.

With a load < 1W a GLE must be switched parallel to the load.

Typical connection

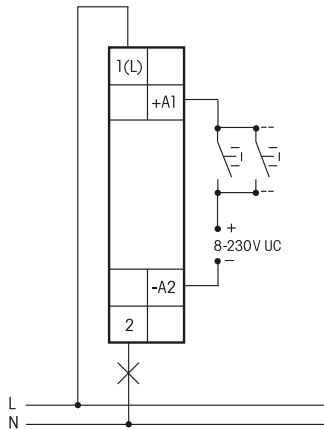

Technical data page 12-16.
Housing for operating instructions GBA14,
see accessoires, chapter Z.

| | | | |
|-------------------|--|-------------------|--------------------|
| ER12SSR-UC | Noiseless solid state relay potential free | EAN 4010312206720 | 44,70 €/pc. |
|-------------------|--|-------------------|--------------------|

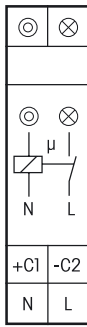

ESR12NP-230V+UC



1 NO contact not potential free 16 A/250 V AC, incandescent lamp load up to 2300 W. Off delay impulse switch with switch-off early warning and pushbutton permanent light switchable. Standby loss 0.5 watt only.

Modular device for DIN-EN 60715 TH35 rail mounting. 1 module = 18 mm wide, 58 mm deep.

Zero passage switching to protect contacts and lamps. This prolongs in particular the lifetime of energy saving lamps.

State-of-the-art hybrid technology combines advantages of nonwearing electronic control with high capacity of special relays.

Control voltage 230 V. In addition electrically isolated universal voltage from 8 to 230 V UC.

Supply voltage and switching voltage 230 V.

Very low switching noise. If the function ESV is set, definitely variable off-delay time RV from 2 to 120 minutes, settable by minute scale.

Contact position indication with two LEDs. This starts blinking in case of a blocked pushbutton (not if the function ER is set).

Glow lamp current up to 150 mA only at the control input 230 V independent from ignition voltage (not if the function ER is set).

Relays with suitable functions to feed back the switching voltage signal of a dimmer switch.

In case of a power failure the system is disconnected in a preset sequence.

The functions ES, ESV or ER are selectable **by means of a rotary switch.**

ES = Impulse switch

ER = Switching relay

ESV = Impulse switch with off delay. The impulse switch automatically disconnects after the set delay is timed out if a manual OFF command has not been given. Infinitely variable time range up to 120 minutes.

ESV = If switch-off early warning \sqcup is set the stairwell lighting starts flickering approximately 0 seconds + \sqcup before timeout at repeated shorter time intervals. During this process reset is possible.

ESV = If push-button permanent light \odot is set permanent light can be switched on by pressing longer + \odot than 1 sec. This switches off automatically after 2 hours or by an operation longer than 2 seconds.

ESV If both switch-off early warning function and permanent light by push-button $\sqcup \odot$ are set, the + $\sqcup \odot$ switch-off early warning function is activated before switching off the permanent light.

This electronic impulse switch does not need a base load for switching lights in rooms which are monitored by a FR12-230V mains disconnection relay.

Function rotary switches

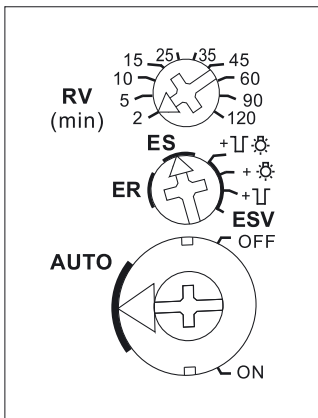

Standard setting ex works.

\sqcup = switch-off early warning

\odot = pushbutton permanent light

$\sqcup \odot$ = switch-off early warning and pushbutton permanent light

Typical connection

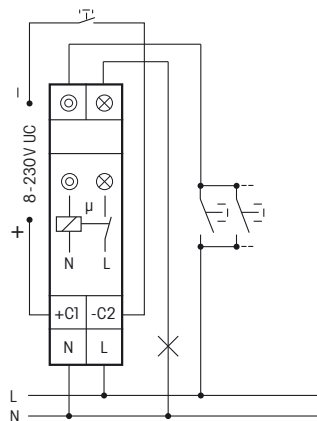

Technical data page 12-16.
Housing for operating instructions GBA14,
see accessoires, chapter Z.

| | | | |
|------------------------|-------------------|-------------------|--------------------|
| ESR12NP-230V+UC | 1 NO contact 16 A | EAN 4010312107928 | 45,70 €/pc. |
|------------------------|-------------------|-------------------|--------------------|

DIGITAL SETTABLE MULTIFUNCTION IMPULSE SWITCH WITH INTEGRATED RELAY FUNCTION ESR12DDX-UC



Typical connection

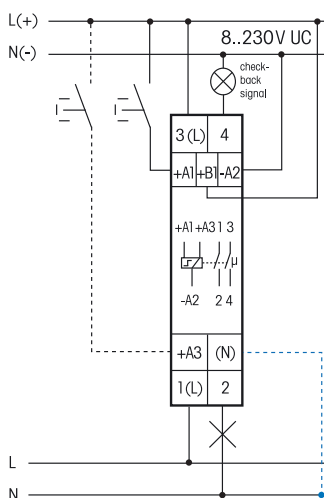

If N is connected, the zero passage switching is active.

ESR12DDX-UC



1+1 NO contacts potential free 16 A/250 V AC. Incandescent lamp load up to 2000 W. Standby loss 0.03–0.4 watt only.

Modular device for DIN-EN 60715 TH35 rail mounting. 1 module = 18 mm wide, 58 mm deep.

With the patented Eltako Duplex technology (DX) the normally potential-free contacts can still switch in zero passage when switching 230V AC 50 Hz and therefore drastically reduce wear. Simply connect the neutral conductor to the terminal (N) and L to 1(L) and/or 3(L) for this. This results in an additional standby consumption of only 0.1 Watt.

Universal control voltage 8 to 230V UC. Supply voltage is same as the control voltage.

The functions are set with the keys MODE and SET as described in the operating instructions. They are indicated on the display and can be blocked if required.

The accrued switch-on time is continuously displayed. First in hours (h), then in months (m) with 1 digit after the decimal point.

By using bistable relays coil power loss and heating is avoided even in the on mode.

The switched consumer may not be connected to the mains before the short automatic synchronisation after installation has terminated.

Only impulse switch functions: After a power failure the system is disconnected in a definite sequence or the switch position is kept depending on the setting (then + on the display next to function abbreviations). Settings under RSM in the menu guidance. Furthermore, when using these functions, with the keys MODE and SET, the control inputs A1 and A3 can be defined as central control inputs.

ZA1 = 'central off' with A1, local with A3; **ZE1** = 'central on' with A1, local with A3;

Z00 = no central control. 'Central on' with A1, 'central off' with A3. No local control refer to function RS.

Relays with suitable functions to feed back the switching voltage signal of a dimmer switch.

From 110V control voltage and in the settings 2S, WS, SS and GS glow lamp current up to 5 mA, dependent on the ignition voltage.

With the keys MODE and SET you can select amongst 18 functions:

- OFF** = Permanent OFF
- 2xS** = 2-fold impulse switch with 1 NO contact each, control inputs A1 and A3
- 2S** = Impulse switch with 2 NO contacts
- WS** = Impulse switch with 1 NO contact and 1 NC contact
- SS1** = Impulse multi circuit switch 1+1 NO contacts for switching sequence
0 - contact 1(1-2) - contact 2(3-4) - contacts 1 + 2
- SS2** = Impulse multi circuit switch 1+1 NO contacts for switching sequence
0 - contact 1 - contacts 1 + 2 - contact 2
- SS3** = Impulse multi circuit switch 1+1 NO contacts for switching sequence
0 - contact 1 - contacts 1 + 2
- GS** = Impulse group switch 1+1 NO contacts for switching sequence
0 - contact 1 - 0 - contact 2
- RS** = Switch with 2 NO contacts, with A1 = set control input and A3 = reset control input
- 2xR** = 2-fold switching relay with 1 NO contact each, control inputs A1 and A3
- 2R** = Switching relay with 2 NO contacts
- WR** = Switching relay with 1 NO contact and 1 NC contact
- RR** = Switching relay (closed-circuit current relay) with 2 NC contacts
- EAW** = Impulse relay for fleeting NO contact and fleeting NC contact with 1+1 NO contacts, wiping time 1 sec each
- EW** = Impulse relay for fleeting NO contact with 1 NO contact and 1 NC contact, wiping time 1 sec
- AW** = Impulse relay fleeting NC contact with 1 NO contact and 1 NC contact, wiping time 1 sec
- GR** = Group relay 1+1 NO contacts (relay with alternating closing contacts)
- ON** = Permanent ON

The control inputs A1 and A3 have the same functions except for 2xS, 2xR and RS, if not used as central control inputs.

After setting the required function, the function can be blocked. An arrow on the right of the abbreviation indicates the blocking status.

Technical data page 12-16.
Housing for operating instructions GBA14,
see accessories, chapter Z.

| | | | |
|--------------------|----------------------|-------------------|--------------------|
| ESR12DDX-UC | 1+1 NO contacts 16 A | EAN 4010312108093 | 62,70 €/pc. |
|--------------------|----------------------|-------------------|--------------------|

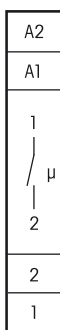

Technical data page 12-16.
Housing for operating instructions GBA14,
see accessoires, chapter Z.

KR09-12V UC



1 NO contact potential free 6 A/250 V AC, incandescent lamp load up to 500 W. No standby loss.

Modular device for DIN-EN 60715 TH35 rail mounting. 1/2 module = 9 mm wide, 55 mm deep.
State-of-the-art hybrid technology combines advantages of nonwearing electronic control with high capacity of special relays.
Control voltages 12 V UC.
Contact position indicator with LED. Control power demand 0.2 W only.
Safe disconnection to VDE 0106, Part 101; therefore, these devices can also be used as coupling relays.

| | | | |
|--------------------|------------------|-------------------|--------------------|
| KR09-12V UC | 1 NO contact 6 A | EAN 4010312203415 | 35,00 €/pc. |
|--------------------|------------------|-------------------|--------------------|



Technical data page 12-16.
Housing for operating instructions GBA14,
see accessoires, chapter Z.

KR09-24V UC



1 NO contact potential free 6 A/250 V AC, incandescent lamp load up to 500 W. No standby loss.

Modular device for DIN-EN 60715 TH35 rail mounting. 1/2 module = 9 mm wide, 55 mm deep.
State-of-the-art hybrid technology combines advantages of nonwearing electronic control with high capacity of special relays.
Control voltages 24 V UC.
Contact position indicator with LED. Control power demand 0.2 W only.
Safe disconnection to VDE 0106, Part 101; therefore, these devices can also be used as coupling relays.

| | | | |
|--------------------|------------------|-------------------|--------------------|
| KR09-24V UC | 1 NO contact 6 A | EAN 4010312203385 | 33,90 €/pc. |
|--------------------|------------------|-------------------|--------------------|

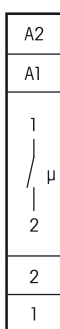

Technical data page 12-16.
Housing for operating instructions GBA14,
see accessoires, chapter Z.

KR09-230V



1 NO contact potential free 6 A/250 V AC, incandescent lamp load up to 500 W. No standby loss.

Modular device for DIN-EN 60715 TH35 rail mounting. 1/2 module = 9 mm wide, 55 mm deep.
State-of-the-art hybrid technology combines advantages of nonwearing electronic control with high capacity of special relays.
Control voltages 230 V.
Contact position indicator with LED. Control power demand 0.2 W only.
Safe disconnection to VDE 0106, Part 101; therefore, these devices can also be used as coupling relays.

| | | | |
|------------------|------------------|-------------------|--------------------|
| KR09-230V | 1 NO contact 6 A | EAN 4010312203378 | 33,90 €/pc. |
|------------------|------------------|-------------------|--------------------|

12-9

COUPLING RELAY KRW12DX-UC

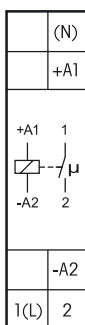

Typical connection

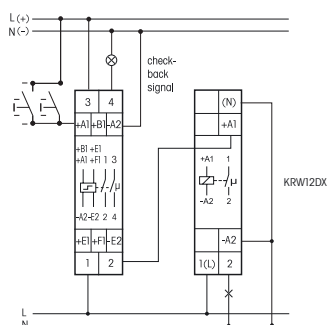

ES12Z with KRW12DX-UC

If N is connected, the zero passage switching is active.

Housing for operating instructions GBA14, see accessoires, chapter Z.

KRW12DX-UC



1 NO contact potential free 16 A/250 V AC with tungsten pre-contact, max. inrush current 500 A/2 ms. No standby loss.

Modular device for DIN-EN 60715 TH35 rail mounting. 1 module = 18 mm wide, 58 mm deep. State-of-the-art hybrid technology combines advantages of nonwearing electronic control with high capacity of special relays.

With the patented Eltako Duplex technology (DX) the normally potential-free contacts can still switch in zero passage when switching 230 V AC 50 Hz and therefore drastically reduce wear. Simply connect the neutral conductor to the terminal (N) and L to 1(L) for this. This gives an standby consumption of only 0.1 watt.

If the contact is used for controlling switching devices which do not perform zero passage switching themselves, (N) should not be connected because the additional closing delay otherwise causes the opposite effect.

Universal control voltage 8 to 230 V UC.

Low switching noise.

Contact position indicator with LED.

By using a bistable relay coil power loss and heating is avoided even in the on mode.

The relay contact can be open or closed when putting into operation. It will be synchronised at first operation.

This relay is not suitable to feed back the switching voltage signal of a dimmer switch. Use only relays ESR12DDX-UC, ESR12NP-230V+UC or ESR61NP-230V+UC for this purpose.

The electronics does not have an internal power supply and therefore no standby loss.

The microcontroller is activated when the control contact closes. This switches the bistable relay to the correct direction. The bistable relay switches back either when the control contact opens or when the control voltage falls.

| | | | |
|-------------------|-------------------|-------------------|--------------------|
| KRW12DX-UC | 1 NO contact 16 A | EAN 4010312206683 | 44,00 €/pc. |
|-------------------|-------------------|-------------------|--------------------|

SWITCHING RELAY ER61-UC
IMPULSE SWITCH WITH INTEGRATED RELAY FUNCTION ESR61NP-230V+UC

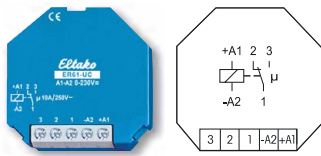

Typical connection

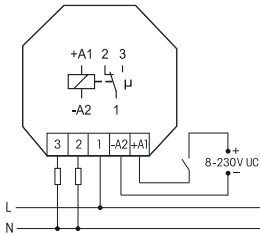

Technical data page 12-16.

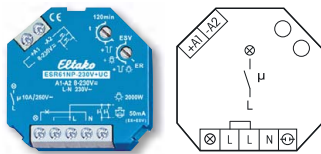

Function rotary switches

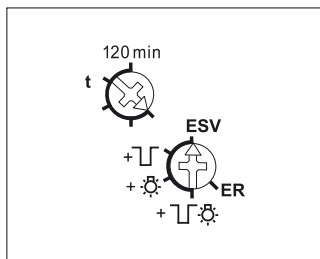

Standard setting ex works.

Typical connection

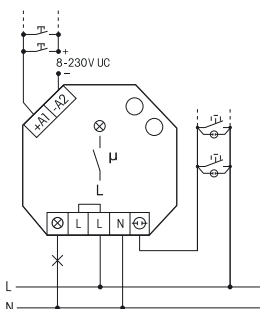

Technical data page 12-16.

Recommended retail prices excluding VAT.

ER61-UC



1 CO contact potential free 10 A/250 V AC, incandescent lamp load up to 2000 W. No standby loss.

For installation. 45 mm long, 45 mm wide, 18 mm deep.

State-of-the-art hybrid technology combines advantages of nonwearing electronic control with high capacity of special relays. Universal control voltage 8 to 230 V UC. Low switching noise.

By using a bistable relay coil power loss and heating is avoided even in the on mode.

The relay contact can be open or closed when putting into operation. It will be synchronised at first operation.

This relay is not suitable to feed back the switching voltage signal of a dimmer switch.

Use only relays ESR12DDX-UC, ESR12NP-230V+UC or ESR61NP-230V+UC for this purpose.

The electronics does not have an internal power supply and therefore no standby loss.

The microcontroller is activated when the control contact closes. This switches the bistable relay to the correct direction. The bistable relay switches back either when the control contact opens or when the control voltage falls.

| | | | |
|----------------|-------------------|-------------------|--------------------|
| ER61-UC | 1 CO contact 10 A | EAN 4010312205358 | 40,70 €/pc. |
|----------------|-------------------|-------------------|--------------------|

ESR61NP-230V+UC



1 NO contact not potential free 10 A/250 V AC, incandescent lamp load up to 2000W. Off delay impulse switch with switch-off early warning and pushbutton permanent light switchable. Standby loss 0.7 watt only.

For installation. 45 mm long, 45 mm wide, 18 mm deep.

Zero passage switching to protect contacts and lamps. This prolongs in particular the lifetime of energy saving lamps.

State-of-the-art hybrid technology combines advantages of nonwearing electronic control with high capacity of special relays.

By using a bistable relay coil power loss and heating is avoided even in the on mode.

The switched consumer may not be connected to the mains before the short automatic synchronisation after installation has terminated.

Control voltage 230 V. In addition electrically isolated universal control voltage from 8 to 230 V UC. Supply voltage and switching voltage 230 V. Very low switching noise. Variable time range up to 120 minutes in the function ESV. At the control input  pushbuttons with a glow lamp current up to 50 mA can be connected.

In case of a power failure the system is disconnected in a preset sequence.

If the timing period is set to minimum in the function ESV, the release delay is switched off.

The standard impulse switch function ES is then set. The function ER is selectable. If the function ER is selected a glow lamp current is not permitted. Only the control input A1- A2 should be used.

When set to the function ER this device is suitable to feed back the switching voltage signal of a dimmer switch.

If switch-off early warning function  is switched on, the light starts flickering approx. 30 seconds before time-out. This is repeated three times at decreasing time intervals.

If the permanent light function  is switched on, the function can be activated by pressing the push-button for longer than 1 second. This function switches off automatically after 2 hours or by pressing the pushbutton for longer than 2 seconds.

If both switch-off early warning function and permanent light by pushbutton  are set, the switch-off early warning function is activated before switching off the permanent light.

| | | | |
|------------------------|-------------------|-------------------|--------------------|
| ESR61NP-230V+UC | 1 NO contact 10 A | EAN 4010312107911 | 43,90 €/pc. |
|------------------------|-------------------|-------------------|--------------------|

MULTIFUNCTION IMPULSE SWITCH WITH INTEGR. RELAY FUNCTION ESR61M-UC

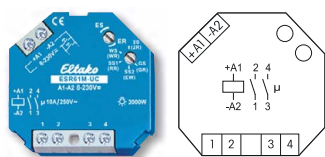

ESR61M-UC



1+1 NO contacts potential free 10 A/250 V AC. Incandescent lamp load up to 2000 W. No standby loss.

For installation. 45 mm long, 45 mm wide, **32 mm deep.**

State-of-the-art hybrid technology combines advantages of nonwearing electronic control with high capacity of special relays.

Universal control voltage 8 to 230 V UC.

No permanent power supply necessary, therefore no standby loss.

By using bistable relays coil power loss and heating is avoided even in the on mode.

The switched consumer may not be connected to the mains before the short automatic synchronisation after installation has terminated.

The functions of the second rotary switch are preselected using the rotary switch ES/ER.

The setting ER selects the function in brackets. 10 different functions are selectable.

2S = Impulse switch with 2 NO contacts

(2R) = Switching relay with 2 NO contacts

WS = Impulse switch with 1 NO contact and 1 NC contact

(WR) = Switching relay with 1 NO contact and 1 NC contact

SS1 = Impulse multi circuit switch 1+1 NO contacts for switching sequence

0 - contact 1(1-2) - contact 2(3-4) - contacts 1 + 2

(RR) = Switching relay (closed-circuit current relay) with 2 NC contacts

SS2 = Impulse multi circuit switch 1+1 NO contacts for switching sequence

0 - contact 1 - contacts 1 + 2 - contact 2

(EW) = Impulse relay for fleeting NO contact with 1 NO contact and 1 NC contact, wiping time 1 sec

GS = Impulse group switch 1+1 NO contacts for switching sequence

0 - contact 1 - 0 - contact 2

(GR) = Group relay 1+1 NO contacts (relay with alternating closing contacts)

This relay is not suitable to feed back the switching voltage signal of a dimmer switch.

Use only relays ESR12DDX-UC, ESR12NP-230V+UC or ESR61NP-230V+UC for this purpose.

Function rotary switches

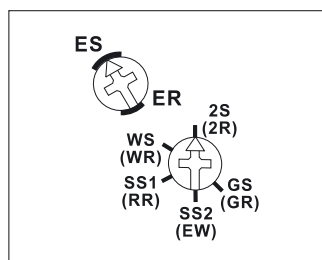

Standard setting ex works.

Typical connection

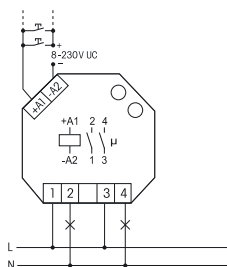

The electronics does not have an internal power supply and therefore no power is consumed in any contact position. A control current flows only during a short control impulse of 0.2 seconds. This activates the microcontroller, reads the last switching state from the non-voltage memory, switches the bistable relay to its opposite state accordingly and rewrites the new switching state to memory

Technical data page 12-16.

| | | | |
|------------------|----------------------|-------------------|--------------------|
| ESR61M-UC | 1+1 NO contacts 10 A | EAN 4010312108079 | 56,80 €/pc. |
|------------------|----------------------|-------------------|--------------------|

NOISELESS IMPULSE SWITCH WITH INTEGRATED RELAY FUNCTION ESR61SSR-230V WITH SOLID STATE RELAY

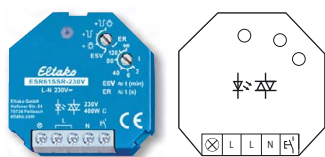

ESR61SSR-230V



Noiseless solid state relay not potential free, 400 watt, Off delay impulse switch with switch-off early warning and pushbutton permanent light switchable. Standby loss 0,3 Watt only.

Function rotary switches

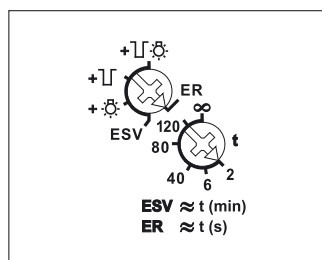

Standard setting ex works.

Typical connection

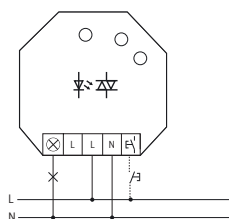

Technical data page 12-16.

For installation. 45 mm long, 45 mm wide, 18 mm deep.

Supply, switching and control voltage 230 V.

Zero passage switching.

In case of a power failure the system is disconnected in a preset sequence.

In the ER function the relay switches back on when the power is restored and the control input is active.

It is not permitted to apply a glow lamp current to the control input.

With automatic electronic overtemperature switch-off.

At a load of < 1W a GLE must be switched in parallel to the load.

Use the top rotary switch to select the required function of this impulse switch:

ER = switching relay

ESV = impulse switch. Possibly with off delay, then

+ = ESV with pushbutton permanent light

+ = ESV with switch-off early warning

+ = ESV with pushbutton permanent light and switch-off early warning

The LED flashes when the rotary switch reaches a new setting range to assist you to find the require position with certainty.

The LED lights up permanently when the relay is switched on.

When the pushbutton permanent light is switched on , set the LED to permanent light by pressing the pushbutton for longer than 1 second. This is indicated by the LED flickering briefly. After 2 hours, the permanent light switches off automatically or it can be switched off previously by briefly pressing the pushbutton.

If the switch-off early warning is switched on, the light starts to flicker approx. 30 seconds before time-out. This is repeated three times at decreasing time intervals.

During the switch-off early warning, the light can be switched back on by briefly pressing the pushbutton. If both switch-off early warning and pushbutton permanent light are switched on, switch-off early warning is activated before automatic switch-off of the permanent light.

The function **ESV on the bottom rotary switch** sets the off delay from 2 to 120 minutes.

In setting ∞ normal impulse switch function ES without off delay, without pushbutton permanent light and without switch-off early warning.

In the ER function a switch-on wipe time can be set between 2 and 120 seconds. On expiry of the wipe time the relay switches off automatically.

In setting ∞ default relay function ER without wipe time.

| | | | |
|----------------------|--|-------------------|--------------------|
| ESR61SSR-230V | Impulse switch with integrated relay function with SSR | EAN 4010312109786 | 44,70 €/pc. |
|----------------------|--|-------------------|--------------------|

ISOLATING RELAY ETR61-230V AND ETR61NP-230V

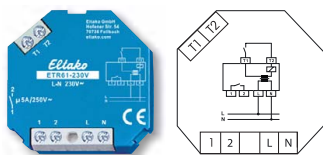

Typical connection

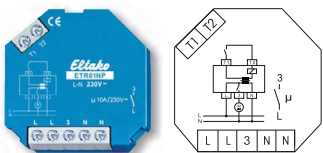
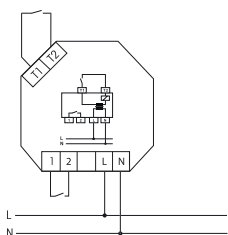

Typical connection

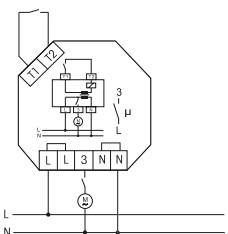

Technical data page 12-16.

ETR61-230V



1 NO contact potential free 5 A/250 V AC. Standby loss 0.5 watt only.

For installation. 45 mm long, 45 mm wide, 18 mm deep.

State-of-the-art hybrid technology combines advantages of nonwearing electronic control with high capacity of special relays.

Control input with internally produced low voltage 24 V DC. With an isolating transformer electrically isolated from power supply and make contact (PELV).

Therefore no external low voltage power supply necessary.

Spacing between power supply and contact: 6 mm.

Power supply 230 V.

| | | | |
|-------------------|------------------|-------------------|--------------------|
| ETR61-230V | 1 NO contact 5 A | EAN 4010312206690 | 35,50 €/pc. |
|-------------------|------------------|-------------------|--------------------|

ETR61NP-230V



1 NO contact not potential free 10 A/250 V AC. With window contact. Standby loss 0.5 watt only.

For installation. 45 mm long, 45 mm wide, 18 mm deep.

State-of-the-art hybrid technology combines advantages of nonwearing electronic control with high capacity of special relays.

Control input with internally produced low voltage 24 V DC. With an isolating transformer electrically isolated from power supply and make contact (PELV).

Therefore no external low voltage power supply necessary.

With 2 L terminals and 2 N terminals for an easy and quick installation.

Power supply 230 V.

| | | | |
|---------------------|-------------------|-------------------|--------------------|
| ETR61NP-230V | 1 NO contact 10 A | EAN 4010312205488 | 35,50 €/pc. |
|---------------------|-------------------|-------------------|--------------------|

ISOLATING RELAY ETR61NP-230V WITH WINDOW CONTACT FK AND WINDOW CONTACT FK

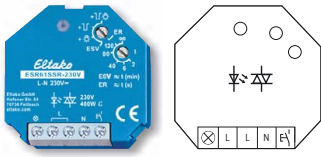

Typical connection

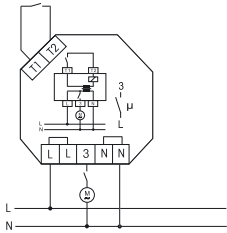

The power supply of an extractor hood is connected by a window contact (NO if window open) so it can be switched on only if the window is open.

Window contact FK



Reed relay and solenoid each
54 x 12 x 10 mm

Technical data page 12-16.

Window contact FK



Reed relay and solenoid each
54 x 12 x 10 mm

ETR61NP-230V+FK



1 NO contact not potential free 10 A/250 V AC. With window contact. Standby loss 0.5 watt only.

For installation. 45 mm long, 45 mm wide, 18 mm deep.

State-of-the-art hybrid technology combines advantages of nonwearing electronic control with high capacity of special relays.

Control input with internally produced low voltage 24 V DC. With an isolating transformer electrically isolated from power supply and make contact (PELV).

Therefore no external low voltage power supply necessary.

With 2 L terminals and 2 N terminals for an easy and quick installation.

Power supply 230 V.

The enclosed window contact consists of a Reed relay with terminals and a solenoid. The NC contact opens when the solenoid approaches closer than 25 mm. The disconnection relay ETR61NP is connected to terminals T1 and T2. Power supply to the extractor only cuts in when the window is open. ETR61NP can be wired in the flush mounted socket behind the socket for the extractor.

Mounting the window contact FK:

Lever out the inserts at the narrow end of the housing. Wire up the Reed relay and cut out the cable entry on the housing. Affix the two housings in parallel maximum 15 mm apart and also screw if necessary. In the longitudinal direction the solenoid may be twisted in any direction compared to the Reed relay.

| | | | |
|------------------------|-------------------|-------------------|--------------------|
| ETR61NP-230V+FK | 1 NO contact 10 A | EAN 4010312205495 | 60,20 €/pc. |
|------------------------|-------------------|-------------------|--------------------|

FK

Window contact

The window contact as described above is also supplied as individual (accessory) item.

Reed relay with 1 NC contact, switching capacity 5 W or VA. Switching voltage max. 175 V UC.

| | | | |
|-----------|----------------|-------------------|--------------------|
| FK | window contact | EAN 4010312903001 | 26,80 €/pc. |
|-----------|----------------|-------------------|--------------------|

TECHNICAL DATA ELECTRONIC SWITCHING RELAYS, CONTROL RELAYS AND COUPLING RELAYS

| Type | ESR12NP-230V+UC | ESR12DDX-UC ^{b)} ER12DX-UC ^{a)} ER12-200-UC ^{a)} ER12-110-UC ^{a)} ER12-001-UC ^{a)} ER12-002-UC ^{a)} | ESR61NP-230V+UC ^{b)} ESR61M-UC ^{a)} ETR61-230V ETR61NP-230V ER61-UC ^{a)} | ER12SSR-UC ESR61SSR-230V | KR09 -12V UC, -24V UC, -230V | KRW12DX-UC ^{a)} |
|---|---|--|---|---|---|--|
| Contacts | | | | | | |
| Contact material/contact gap | AgSnO ₂ /0.5 mm | | | Opto Triac | AgSnO ₂ /0.5 mm | W+AgSnO ₂ /0.5 mm |
| Spacing of control connections/contact | 3 mm | 6 mm | 6 mm, ER61: 3 mm | | 6 mm | 6 mm |
| Spacing of control connections C1-C2 or A1-A2/contact | 6 mm | 6 mm | ESR61NP+M: 6 mm | – | – | – |
| Test voltage contact/contact | – | ESR12DDX: 4000 V ER12-200/110: 2000 V | ESR61M: 2000 V | – | – | – |
| Test voltage control connections/contact Test voltage C1-C2 or A1-A2/contact | 2000 V 4000 V | 4000 V – | 2000 V ESR61NP+M+ETR61NP: 4000 V | – | 4000 V – | 4000 V – |
| Rated switching capacity | 16 A/250 V AC | 16 A/250 V AC ⁴⁾ | 10 A/250 V AC ETR61: 5 A/250 V AC | – | 6 A/250 V AC | 16 A/250 V AC |
| Incandescent lamp and halogen lamp load ¹⁾ 230 V, I on ≤ 70 A/10 ms | 2300 W | 2000 W | 2000 W ETR61: 1000 W | up to 400 W | 500 W | 3300 W |
| Fluorescent lamp load with KVG* in lead-lag circuit or non compensated | 1000 VA | 1000 VA | 1000 VA | – | 600 VA | 1000 VA |
| Fluorescent lamp load with KVG* shunt-compensated or with EVG* | 500 VA | 500 VA | 500 VA | up to 400 VA ⁵⁾ | 300 VA | 500 VA |
| Compact fluorescent lamps with EVG* and energy saving lamps ESL | 15x7 W 10x20 W ⁵⁾ | I on ≤ 70 A/10 ms ²⁾ When using DX types: 15x7 W 10x20 W ³⁾⁵⁾ | I on ≤ 70 A/10 ms ²⁾ ESR61NP: 15x7 W, 10x20 W ⁵⁾ | up to 400 W ⁵⁾ | 52 W | I on ≤ 500 A/2 ms ²⁾ |
| 230 V LED lamps | up to 200 W ⁵⁾ I on ≤ 30 A/20 ms | up to 200 W ⁵⁾ I on ≤ 120 A/5 ms | up to 200 W ⁵⁾ I on ≤ 120 A/5 ms | up to 400 W ⁵⁾ I on ≤ 120 A/ 20 ms | up to 50 W ⁵⁾ I on ≤ 10 A/10 ms | up to 500 W ⁵⁾ I on ≤ 500 A/2 ms |
| Max. switching current DC: 12 V/24 V DC | – | 8 A | 8 A (not ESR) | – | 6 A | – |
| Life at rated load, cos φ = 1 or for incandescent lamps 1000 W at 100/h | > 10 ⁵ | > 10 ⁵ | > 10 ⁵ | ∞ | > 10 ⁵ | > 10 ⁵ |
| Life at rated load, cos φ = 0.6 at 100/h | > 4x10 ⁴ | > 4x10 ⁴ | > 4x10 ⁴ | – | – | > 4x10 ⁴ |
| Max. operating cycles | 10 ³ /h | 10 ³ /h | 10 ³ /h | 10 ³ /h | 10 ⁴ /h | 10 ³ /h |
| Contact position indication | LED (not series 61) | | | | | |
| Maximum conductor cross-section | series 12: 6 mm ² (3-fold terminal 4 mm ²), series 61: 4 mm ² | | | | | |
| Two conductors of same cross-section | series 12: 2.5 mm ² (3-fold terminal 1.5 mm ²), series 61: 1.5 mm ² | | | | | |
| Screw head | series 12: slotted/crosshead, pozidriv, series 61: slotted/crosshead | | | | | |
| Type of enclosure/terminals | series 12: IP50/IP20, series 61: IP30/IP20 | | | | | |
| Electronics | | | | | | |
| Time on | 100% | | | | | |
| Max./min. temperature at mounting location | +50°C/-20°C | | | | | |
| Stand by loss (active power) | 0.5 W | – ESR12DDX: 0.4 W | – ESR61NP: 0.7 W, ETR61+ ETR61NP: 0.5 W | – ESR61SSR: 0.3 W | – | – |
| Control current 230 V control input local ±20% | 10 mA | – | 10 mA, ER61 and ESR61M: – | 1 mA | – | – |
| Control current universal control voltage all control voltages mA ± 20% | – | 4 (not ESR12DDX) | ER61: 2, ESR61M: 4 | 4 | – | 4 |
| Control current at 8/12/24/230 V (<10 s) mA ± 20% | 2/4/9/5(100) | only ESR12DDX: 2/3/7/3(50) mA | only ESR61NP: 2/4/9/5(100) only ETR61+ ETR61NP: 10 mA/24 V DC | – | –/15/10/11 | – |
| Max. parallel capacitance (approx. length) of control lead at 230 V AC | ES: 0.3 μF (1000 m) ER: 3 nF (10 m) C1-C2: 15 nF (50 m) | 0.06 μF (200 m) ESR12DDX: 0.3 μF (1000 m) | 0.06 μF (200 m) | 30 nF (100 m) | 0.06 μF (200 m) | 0.06 μF (200 m) |

* EVG = electronic ballast units; KVG = conventional ballast units ^{a)} Bistable relay as relay contact. The relay contact can be open or closed when putting into operation. It will be synchronised at first operation. ^{b)} Bistable relay as relay contact. The switched consumer may not be connected to the mains before the short automatic synchronisation after installation has terminated. ¹⁾ For lamps with 150 W max. ²⁾ A 40-fold inrush current must be expected for electronic ballast devices. For steady loads of 1200 W or 600 W use the currentlimiting relay SBR12 or SBR61. See chapter 14, page 14-8. ³⁾ When using DX types close attention must be paid that zero passage switching is activated! ⁴⁾ For ER12-200 maximum current across both contacts 16 A for 230 V. ⁵⁾ Usually applies for dimmable energy saving lamps and dimmable 230 V LED lamps. Due to differences in the lamps electronics, there may be a restriction on the maximum number of lamps; especially if the connected load is very low (for 5 W-LEDs).

To comply with DIN VDE 0100-443 and DIN VDE 0100-534, a Type 2 or Type 3 surge protection device (SPD) must be installed.