

**FTS61BTK  
B4T65  
FTS14KS**



**2 THE REMOTE SWITCH SYSTEM FTS14 –  
COMBINING DEVICES AND FUNCTIONS FLEXIBLY.  
TAKE ADVANTAGE OF THE NEW POSSIBILITIES  
OF SERIES 14.**

# The remote switch system FTS14 - Modular RS485 bus

|   |      |
|---|------|
| The remote switch system <b>FTS14</b> - modular RS485 bus of the next generation  | 2-2  |
| Input module <b>FTS14EM</b>   | 2-4  |
| <b>FTS14</b> communication interface <b>FTS14KS</b>   | 2-5  |
| Optional: Pushbutton gateway <b>FTS14TG</b> and bus pushbutton <b>B4T65</b> and <b>B4FT65</b>                                       | 2-6  |
| Bus pushbutton coupler <b>FTS61BTK</b> and bus pushbutton coupler <b>FTS61BTKL</b>  | 2-7  |
| Optional: Wireless output module <b>FTS14FA</b>   | 2-8  |
| The input module <b>FTS14EM</b> with Series 14 actuators  | 2-9  |
| The input module <b>FTS14EM</b> with actuators in combination with <b>FAM14</b> to expand the Wireless Building                     | 2-10 |
| The wireless output module <b>FTS14FA</b> with <b>FTS14TG</b> , <b>FTS14EM</b> and actuators  | 2-11 |
| The pushbutton gateway <b>FTS14TG</b> with bus pushbutton coupler <b>FTS61BTK</b> and bus pushbuttons <b>B4T65</b> or <b>B4FT65</b> | 2-12 |
| All possible combinations <b>FTS14KS</b> , <b>FAM14</b> , <b>FTS14TG</b> , <b>FTS14EM</b> and <b>FTS14FA</b> and actuators          | 2-13 |

# THE REMOTE SENSING SYSTEM FTS14 USES THE NEW FEATURES OF OUR SERIES 14

2-2

The bus and power supply connections on the input module FTS14EM, communication interface FTS14KS and actuators as DIN rail mounted devices are very simply cross-wired by means of jumpers. A customary screened 4-wire telephone line acts as bus line to connect several distributors together.

**The FTS14 bus and the input module FTS14EM use exactly the same telegram structure as the Wireless Building DIN rail mounted devices of the Series 14 and are therefore directly combinable with actuators and other components in the Series 14. All the necessary functions of current production are then immediately available.**

**The power supply in the FTS14KS decouples the electronics of all connected devices from the 230 V power supply grid. As a result, the devices are not exposed to voltage peaks and other faults which are becoming increasingly frequent on mains power supplies. This protection significantly increases the expected service life of the devices.**

Every FTS14EM with only two pitches width has 10 inputs for either conventional pushbuttons, window/door-contacts or motion sensors. Thanks to the electrically isolated universal control voltage from 8 to 230V UC, the inputs can be controlled either directly with the mains voltage or with low voltage. A separate switch mode power supply unit, e.g. the SNT12 which is only one pitch unit wide, must then be used for 12 V or 24 V. Control power requirement is only 0.05 or 0.2 watts per pushbutton when a pushbutton is operated. All input terminals (E1 to E10) are arranged in the lower terminal blocks and a terminal for the common pushbutton reference potential (-E) is located on the upper terminal block.

The FTS14EM can be configured by 2 rotary switches in such a way that **max. 50 FTS14EM devices** can be connected to **max. 500 pushbuttons in a bus installation**. In addition the pushbutton inputs of each FTS14EM are set by rotary switch either as universal pushbuttons or in pairs as direction pushbuttons. The telegram of each pushbutton input in the entire bus is available over the bus system simultaneously for all actuators connected. It is therefore possible to install central and group pushbuttons rapidly and using few wires. The related pushbuttons are simply taught-in in the required actuators on the bus.

The connected actuators can also be configured with the PC tool PCT14 via communication interface of the FTS14KS.

→ **Optional:** Instead of the FTS14KS a **wireless antenna module FAM14** (from the Wireless Building System), which is only two pitch units wide, can also be installed. Actuators can then be activated via the FTS14EM by wireless pushbuttons, handheld transmitters and wireless sensors as well as conventional pushbuttons. The bidirectional FAM14 also permits a Smart Home central unit SafeIV to evaluate feedback messages from the actuators transferred by wireless. Each actuator status is then displayed and can also be changed. Connecting the HOLD terminals of all devices regulates bus access and prevents collisions.

→ **Optional:** The **pushbutton gateway FTS14TG**, which is only two pitch units wide, can feed telegrams from the **4-way bus pushbuttons B4T65, B4FT65** and **pushbutton coupler FTS61BTK** connected by 2-wire pushbutton bus to conventional pushbuttons connected to the bus. Data transfer and power supply take place simultaneously over 2 wires only. This avoids many single pushbutton control lines. This avoids many single pushbutton control lines. An FTS14EM device is then not required.

→ **Optional:** Pushbutton telegrams on the bus can be sent directly to the Wireless Building system with a **wireless output module FTS14FA**, e.g. to control decentral actuators.

→ **Optional:** The **multiple gateway FGW14**, which is only one pitch unit wide, can set up connections to the Smart Home central unit SafeIV, bus components of the previous Series 12 and an RS232 interface. In addition to this, two RS485 buses from Series 14 can be connected.

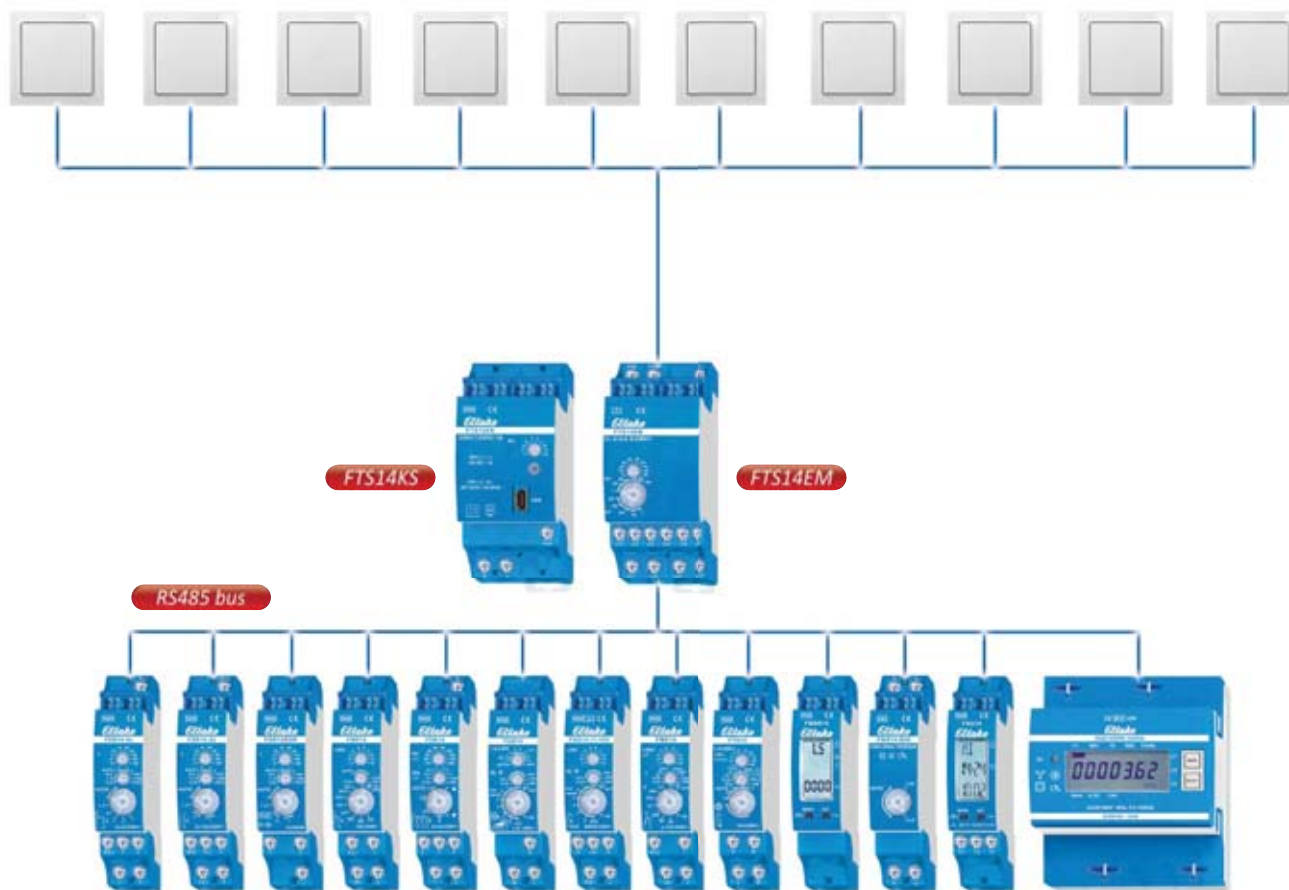

All optional possibilities can be combined as required: FTS14EM with actuators, the wireless antenna module FAM14, the pushbutton wireless output module FTS14FA and the pushbutton gateway FTS14TG for connection to pushbutton couplers FTS61BTK.

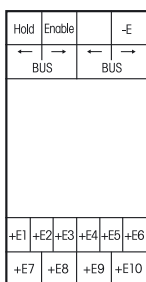

# FTS14EM



**Input module for the Eltako RS485 bus, 10 control inputs for universal control voltage. Only 0.1 watt standby loss.**

Modular device for DIN-EN 60715 TH35 railmounting.  
2 modules = 36 mm wide, 58 mm deep.

**Connection to the Eltako-RS485 bus. Bus cross wiring and power supply with jumper.**

**Operation in conjunction with FTS14KS or FAM14.**

10 control inputs +E1 to +E10/-E electrically isolated from the supply voltage.

Control voltage: 8..230 V UC.

The control inputs can be either activated for pushbuttons (delivery state), window-door contacts or motion detectors.

From the production week 21/19 the signals of the control inputs can be inverted.

**Control inputs for pushbuttons:** telegrams of pushbuttons will be generated (e.g. 0x70).

Each FTS14EM can be set to UT (= universal pushbutton) or RT (= direction pushbutton) on the lower rotary switch.

**Control inputs for window-door contacts:** telegrams of the window-door contact FTK are generated (EEP D5-00-01). If the input is driven by the contact with the control voltage to be applied externally, the telegram 'window open' is generated. If the contact is opened, the telegram 'window open' is generated. As with the wireless sensor FTK, the status telegram is repeated every 15 minutes.

**Control inputs for motion detectors:** telegrams of the wireless motion/brightness sensor FBH are generated (EEP A5-08-01), wherein the brightness value is always 0. If the input is driven by the contact with the control voltage to be applied externally, the telegram 'motion' is generated. If the contact is opened, the telegram 'no motion' will be generated. As with the wireless sensors FBH, the status telegram is repeated every 15 minutes.

Each telegram of a contact input has to be taught-in with an identification number (ID) into one or more actuators according to the operating instructions.

**The lower rotary switch** defines the group to which an FTS14EM belongs. A total of 5 groups are available (1, 101, 201, 301 and 401) each with 100 IDs.

**The upper rotary switch** (0 to 90) sets the ID within a group. The ID range within a group results from the combination of upper and lower rotary switches and must be set differently on each FTS14EM. Maximum ten FTS14EMs form a group. Therefore, a total of 50 FTS14EMs comprising 500 pushbuttons or contacts are possible in one RS485 bus.

To generate the necessary **teach-in telegrams** for teaching-in into the actuators, the requested group has to be selected on the upper and lower rotary switch. For pushbuttons in the range UT or RT or for window-door contacts and motion sensors in the range RT. Then confirm the required control input.

**In operation**, the same group should be selected for window-door contacts and motion sensors in the range UT or RT for pushbutton or UT.

The LED below the upper rotary switch flashes briefly, when a connected contact is closed.

**Optional:** An **FAM14 wireless antenna module** (from Wireless Building System) which is only two modules wide can also be installed. Actuators can then be activated via the FTS14EM by wireless pushbuttons and contacts, handheld transmitters and wireless sensors in addition to conventional buttons. As the FAM14 has an integrated switch mode power supply unit, the FTS14KS is no longer required for power supply in this configuration.

The bidirectional FAM14 also permits a Smart Home central unit SafeIV to evaluate feedback messages from the actuators transferred by wireless. Each actuator status is then displayed and can also be changed. Connecting the HOLD terminals of all devices regulates bus access and prevents collisions.

The telegrams of the FTS14EM can also be sent to the Eltako Wireless Building **with the optional wireless output module FTS14FA.**

## Function rotary switches

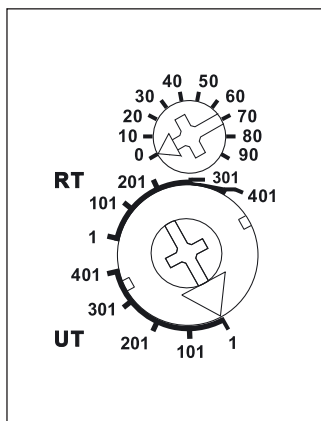

Standard setting ex works.

Housing for operating instructions GBA14 page 1-44.

|                |              |                   |                    |
|----------------|--------------|-------------------|--------------------|
| <b>FTS14EM</b> | Input module | EAN 4010312315071 | <b>58,10 €/pc.</b> |
|----------------|--------------|-------------------|--------------------|

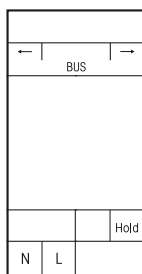

# FTS14KS



**FTS14 communication interface for the Eltako RS485 bus with integrated power supply unit 12V DC/8 W. Only 0.6 watt standby loss.**

Modular device for DIN-EN 60715 TH35 rail mounting.  
2 module = 36 mm wide, 58 mm deep.  
Supply voltage 230 V.

The delivery includes 2 terminators with printing  $\Omega$ , 1/2 module, 3 jumpers 1 module (including 1 spare), 2 jumpers 1/2 module (including 1 spare) and 1 jumper installation tool SMW14.

**Bus cross wiring and power supply with jumper.**

The attached second terminator should be plugged **to the last actuator.**

**Mini USB to connect to a PC, to create an equipment list, to configurate the actuators using the PC tool PCT14 and for data backup.** A legalization code to download the PCT14 from the Eltako homepage [www.eltako.com](http://www.eltako.com) is included in the FTS14KS.

All FTS14EM and if needed gateways FGW14 will be connected to the terminal Hold when they connect a PC with a RS232 bus.

According to the operating manual 10 different operating modes can be set with the operating mode rotary switch BA.

**The bottom LED** lights up green if a connection from the PC tool PCT14 was created. When reading or writing date the LED flashes green. The green LED goes out if the connection from the PC tool PCT14 was terminated.

At a load of more than 50% of the rated capacity of 8 W a ventilation clearance of 1/2 module must be maintained with the spacer DS14 on the left side.

**Function rotary switch**

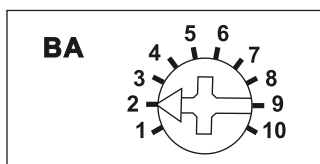

Standard setting ex works.

Housing for operating instructions GBA14 page 1-44.

2-5

|                |                               |                   |                    |
|----------------|-------------------------------|-------------------|--------------------|
| <b>FTS14KS</b> | FTS14 communication interface | EAN 4010312315651 | <b>77,10 €/pc.</b> |
|----------------|-------------------------------|-------------------|--------------------|

## OPTIONAL: PUSHBUTTON GATEWAY FTS14TG AND BUS PUSHBUTTON B4T65, B4FT65

2-6

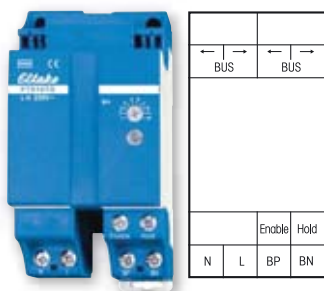

### Function rotary switch

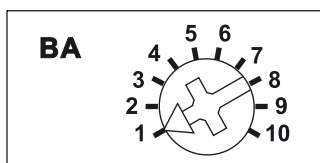

Standard setting ex works.

Description FTS61BTK and FTS61BTKL on page 2-7.



Bus pushbutton with double rocker



Bus pushbutton with rocker

Typical connections on page 2-12 and 2-13.

## FTS14TG



**Optional: Pushbutton gateway for FTS14 systems. Only 1.3 watt standby loss.**

Modular device for DIN-EN 60715 TH35 railmounting. 2,5 modules = 45 mm wide, 58 mm deep. To improve heat dissipation, provide a ventilation gap  $\frac{1}{2}$  a pitch unit wide on the left-hand side. Use the enclosed spacer DS14 for this purpose. Power supply 230 V.

**Connection to the Eltako-RS485 bus. Bus cross wiring and power supply with jumper. Operation in conjunction with FAM14 or FTS14KS.**

Using up to **3 pushbutton gateways FTS14TG**, you can feed the telegrams of up to 90 **4-way bus switches B4T65 and B4FT65** or **pushbutton bus couplers FTS61BTK and FTS61BTKL** connected over a 2-wire bus with conventional pushbuttons connected to them. Data transfer and power supply take place simultaneously over 2 wires only. This avoids a mass of single pushbutton control lines. An FTS14EM device is then not required.

**Up to 30 B4T65, B4FT65, FTS61BTK and FTS61BTKL devices can be connected to an FTS14TG pushbutton gateway.**

A voltage of 29 V DC is supplied to the connected devices over a 2-wire bus which is also used for data transfer.

Please use only conventional bus or telephone lines.

The 2-wire bus is electrically isolated from the Eltako RS485 bus.

The permitted maximum line length is 200 m. The RLC device enclosed with the FTS14TG must also be connected to the terminals BP and BN on the bus switch or pushbutton bus coupler furthest away.

Pushbutton telegrams from the connected devices are transmitted by an FTS14FA device over the Eltako RS485 bus and over the Eltako building wireless system.

| RLC element | Range extension for FTS14TG | EAN 4010312907092 | 4,00 €/pc.  |
|-------------|-----------------------------|-------------------|-------------|
| FTS14TG     | Pushbutton gateway          | EAN 4010312315088 | 79,10 €/pc. |

## B4T65 AND B4FT65



**Bus switch 84 x 84 mm external for connection to FTS14TG pushbutton gateway by 2-wire pushbutton bus. Pure white, glossy. Only 0.2 watt standby loss. B4FT65 bus 4-way flat pushbutton in E-design, only 11mm high. B4T65 bus 4-way pushbutton in E-Design, only 16 mm high.**

The scope of supply comprises the R1E resp. RF1E frame including snapped-on electronics, a flat rocker and a flat double rocker (all the same colour).

The double rocker permits entry of 4 evaluable signals, but the rocker allows only 2 signals.

At the rear, a 20 cm long red/black by pushbutton bus line is routed externally. Red terminal to BP, black to BN of a pushbutton gateway FTS14TG.

**Up to 30 bus switches and/or FTS61BTK pushbutton bus couplers can be connected to terminals BP and BN of an FTS14TG pushbutton gateway.**

The permitted maximum line length is 200 m. The RLC device enclosed with the FTS14TG must also be connected to the terminals BP and BN on the bus switch or pushbutton bus coupler furthest away.

A voltage of 29 V DC is supplied to the connected B4 over a 2-wire pushbutton bus which is also used for data transfer.

Please use only conventional bus or telephone lines.

Confirmation telegrams from actuators are displayed by 4 resp. 2 yellow LEDs when the actuator IDs are entered by the PCT14 in the ID table of the FTS14TG.

| B4FT65-wg   | Bus flat pushbutton              | EAN 4010312315682 | 43,40 €/pc. |
|-------------|----------------------------------|-------------------|-------------|
| B4T65-wg    | Bus pushbutton in E-Design       | EAN 4010312315675 | 42,10 €/pc. |
| RLC element | Range extension for B4T65/B4FT65 | EAN 4010312907092 | 4,00 €/pc.  |

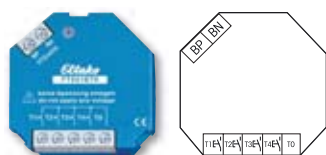

## FTS61BTK



**Bus pushbutton coupler FTS61BTK for 4 conventional pushbuttons for connection to FTS14TG pushbutton gateways by 2-wire pushbutton bus. Only 0.2 watt standby loss.**

For installation. 45 mm long, 45 mm wide, 18 mm deep.

Up to 30 bus pushbuttons and/or bus pushbutton couplers FTS61BTK devices can be connected to the BP and BN terminals of a pushbutton gateway FTS14TG. The permitted total line length is 200 m. The RLC device enclosed with the FTS14TG must also be connected to the terminals BP and BN on the bus switch or pushbutton bus coupler furthest away.

A voltage of 29 V DC is supplied to the connected FTS61BTK over a 2-wire pushbutton bus which is also used for data transfer.

Please use only conventional bus or telephone lines.

Up to four conventional pushbuttons can be connected to T1, T2, T3 and T4 by a maximum line length of 2 metres. Connect the opposite pole to the T0 terminal in each case.

**Caution: Do not apply any voltage.**

The pairs T1/T3 and T2/T4 can be defined as direction pushbuttons.

Connect the bus to BP and BN. Make sure the polarity is correct.

Typical connections on page 2-12 and 2-13.

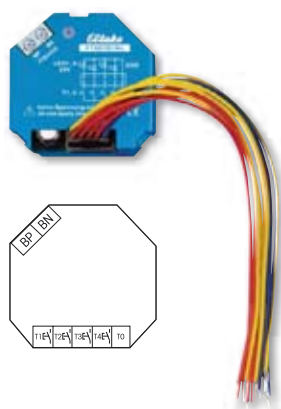

## FTS61BTKL



**Bus pushbutton coupler FTS61BTKL for 4 conventional pushbuttons with integrated 24 V LEDs for connection to FTS14TG pushbutton gateways by 2-wire pushbutton bus. Only 0.2 watt standby loss.**

For installation. 45 mm long, 45 mm wide, 18 mm deep.

Up to 30 bus pushbuttons and/or bus pushbutton couplers FTS61BTKL devices can be connected to the BP and BN terminals of a pushbutton gateway FTS14TG. The permitted total line length is 200 m. The RLC device enclosed with the FTS14TG must also be connected to the terminals BP and BN on the bus switch or pushbutton bus coupler furthest away.

A voltage of 29 V DC is supplied to the connected FTS61BTKL over a 2-wire pushbutton bus which is also used for data transfer.

Please use only conventional bus or telephone lines.

Up to four conventional pushbuttons T1-T4 can be connected to the 15 cm long connecting cables. Each opposite pole is T0. The connecting cables can be extended up to 2 m. With the 24 V LEDs integrated in the pushbuttons, confirmation telegrams of actuators are displayed if the IDs of the actuators were registered into the ID table of the FTS14TG with PCT14.

**Caution: Do not apply any voltage.**

The pairs T1/T3 and T2/T4 can be defined as direction pushbuttons.

Connect the bus to BP and BN. Make sure the polarity is correct.

|                 |                        |                   |                    |
|-----------------|------------------------|-------------------|--------------------|
| <b>FTS61BTK</b> | Bus pushbutton coupler | EAN 4010312315668 | <b>43,90 €/pc.</b> |
|-----------------|------------------------|-------------------|--------------------|

|                  |   |                   |                    |
|------------------|---|-------------------|--------------------|
| <b>FTS61BTKL</b> | Bus pushbutton coupler for feedback LED | EAN 4010312316801 | <b>49,90 €/pc.</b> |
|------------------|---|-------------------|--------------------|



## OPTIONAL: WIRELESS OUTPUT MODULE FTS14FA

2-8

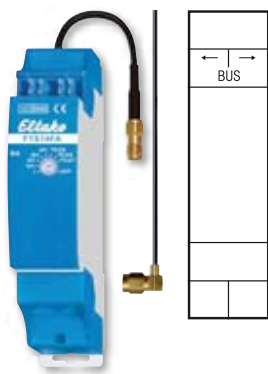

The enclosed small antenna can be replaced with a wireless antenna FA250 or if need be FA200 with magnetic base and cable.

### Mode switch

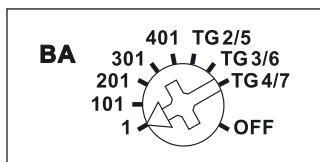

Standard setting ex works.

Housing for operating instructions GBA14 page 1-44.

## FTS14FA



**Optional: Wireless output module pushbutton telegrams for FTS14 systems with FTS14EM and/or FTS14TG. Only 0.5 watt standby loss.**

Modular device for DIN-EN 60715 TH35 rail mounting.

1 module = 18 mm wide, 58 mm deep.

**Connection to the Eltako-RS485 bus. Bus cross wiring and power supply with jumper.**

**Operation in conjunction with FTS14KS with or without FAM14.**

A rotary switch defines the FTS14EM or FTS14TG group to which an FTS14FA belongs. Therefore a maximum of 8 FTS14FAs can be connected to a bus. Every pushbutton telegram from an FTS14EM or FTS14TG is sent with its own ID to the Eltako building wireless system.

**Rotary switch on the FTS14FA set to position 1:** Sends telegrams of all FTS14EMs set to 1.

**Rotary switch on the FTS14FA set to position 101:** Sends telegrams of all FTS14EMs set to 101.

**Rotary switch on the FTS14FA set to position 201:** Sends telegrams of all FTS14EMs set to 201.

**Rotary switch on the FTS14FA set to position 301:** Sends telegrams of all FTS14EMs set to 301.

**Rotary switch on the FTS14FA set to position 401:** Sends telegrams of all FTS14EMs set to 401.

**Rotary switch on the FTS14FA set to position TG2/5:** Sends telegrams of all FTS14TG set to 2 or 5.

**Rotary switch on the FTS14FA set to position TG3/6:** Sends telegrams of all FTS14TG set to 3 or 6.

**Rotary switch on the FTS14FA set to position TG4/7:** Sends telegrams of all FTS14TG set to 4 or 7.

**Rotary switch on the FTS14FA set to position OFF:** The FTS14FA is switched off.

The green LED under the rotary switch will flash shortly when a wireless telegram is sent.

Telegrams from an FAM14 are not sent by the FTS14FA.

|         |                        |                   |             |
|---------|------------------------|-------------------|-------------|
| FTS14FA | Wireless output module | EAN 4010312315101 | 89,90 €/pc. |
|---------|------------------------|-------------------|-------------|

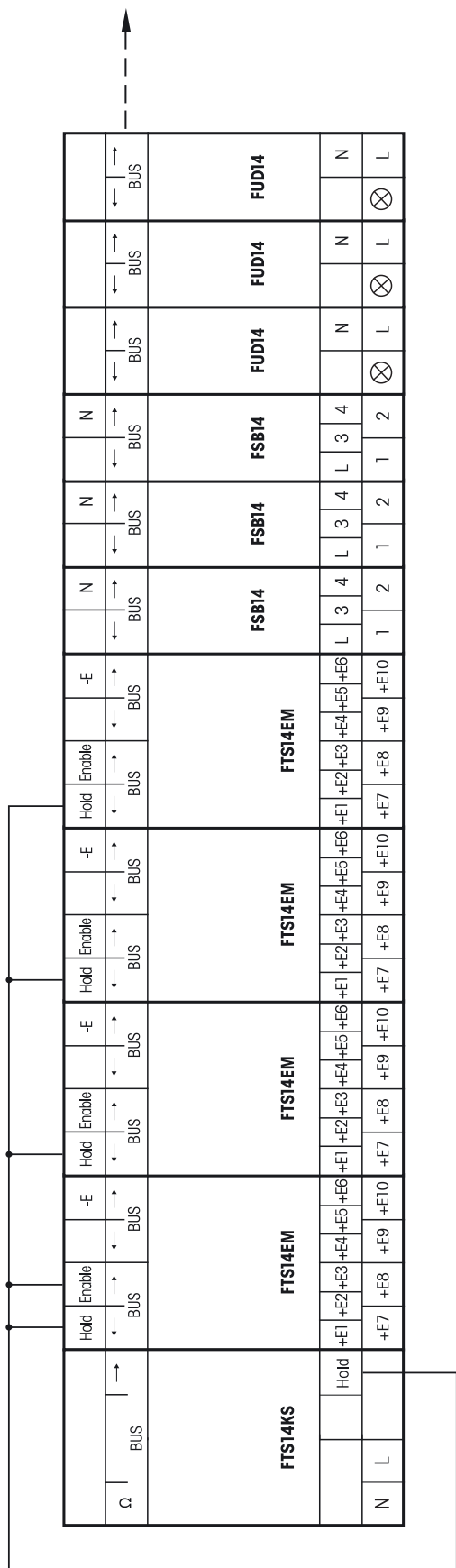

The second terminator which is included in the FTS14KS has to be plugged to the last actuator.

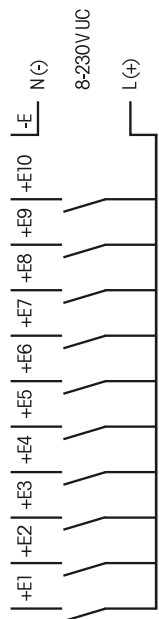

Control inputs FTS14EM

# THE INPUT MODULE FTS14EM WITH ACTUATORS IN COMBINATION WITH FAM14 TO EXPAND THE WIRELESS BUILDING

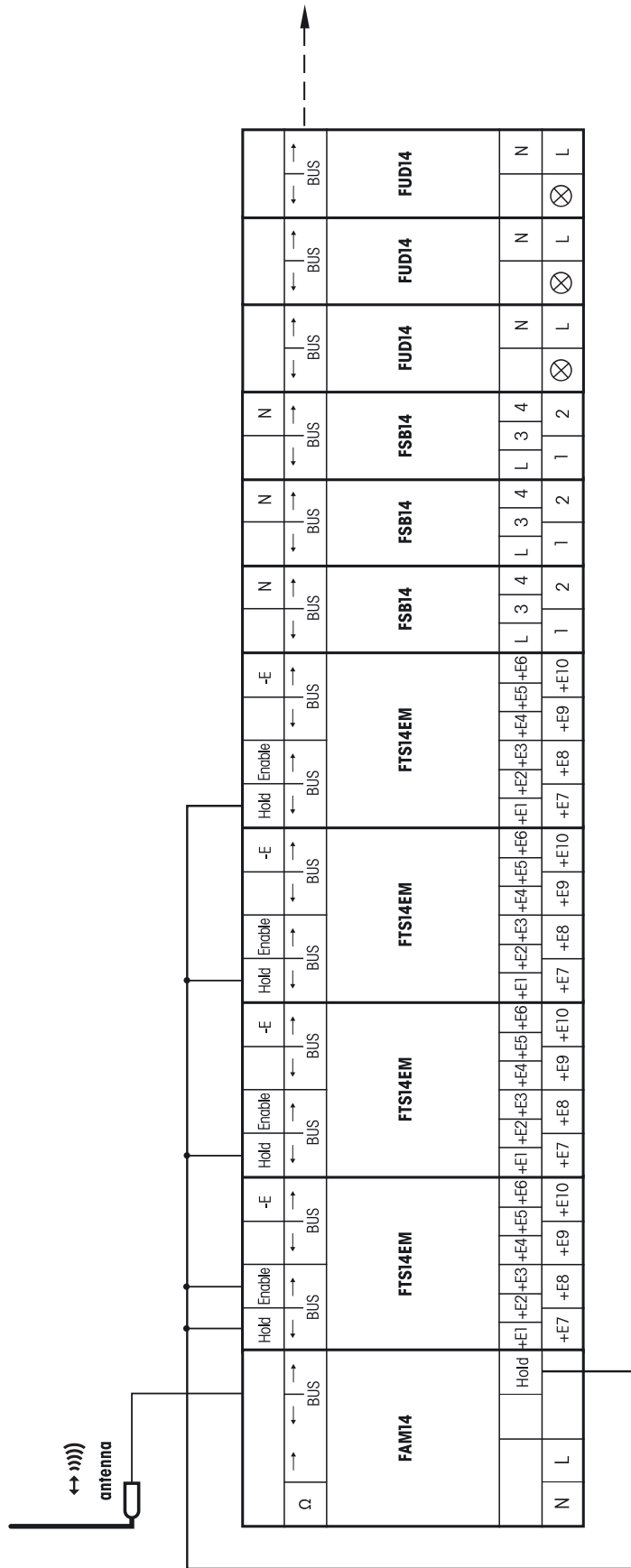

The second terminator which is included in the FAM14 has to be plugged to the last actuator.

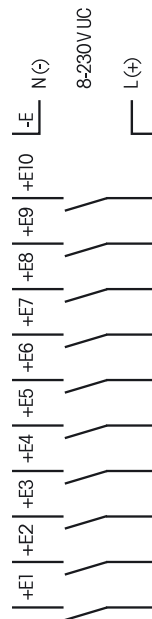

Control inputs FTS14EM

**THE WIRELESS OUTPUT MODULE FTS14FA  
WITH FTS14TG, FTS14EM AND ACTUATORS**

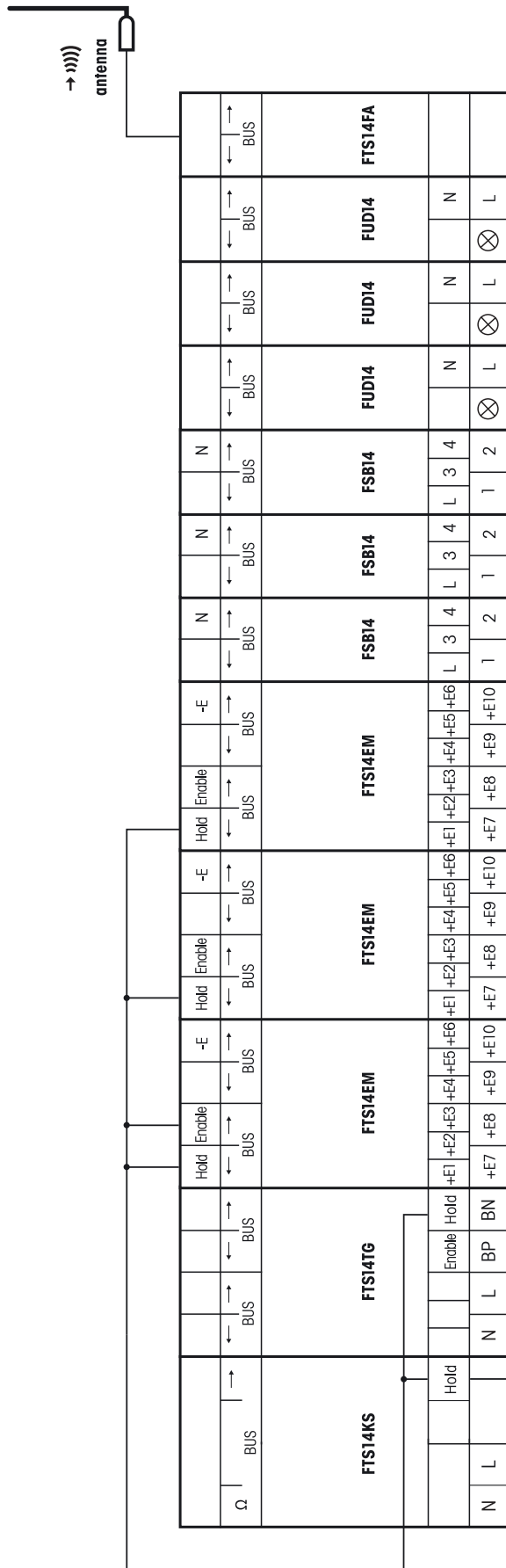

The second terminating resistor supplied with the FTS14KS must be plugged into the last bus user.

Every FTS14FA generates wireless telegrams from up to 5 FTS14EM pushbutton input modules and up to 3 FTS14TG pushbutton gateways.

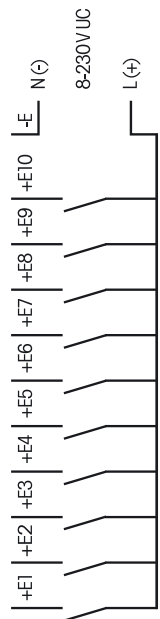

Control inputs FTS14EM



### ALL POSSIBLE COMBINATIONS FTS14KS, FAM14, FTS14TG, FTS14EM AND FTS14FA AND ACTUATORS

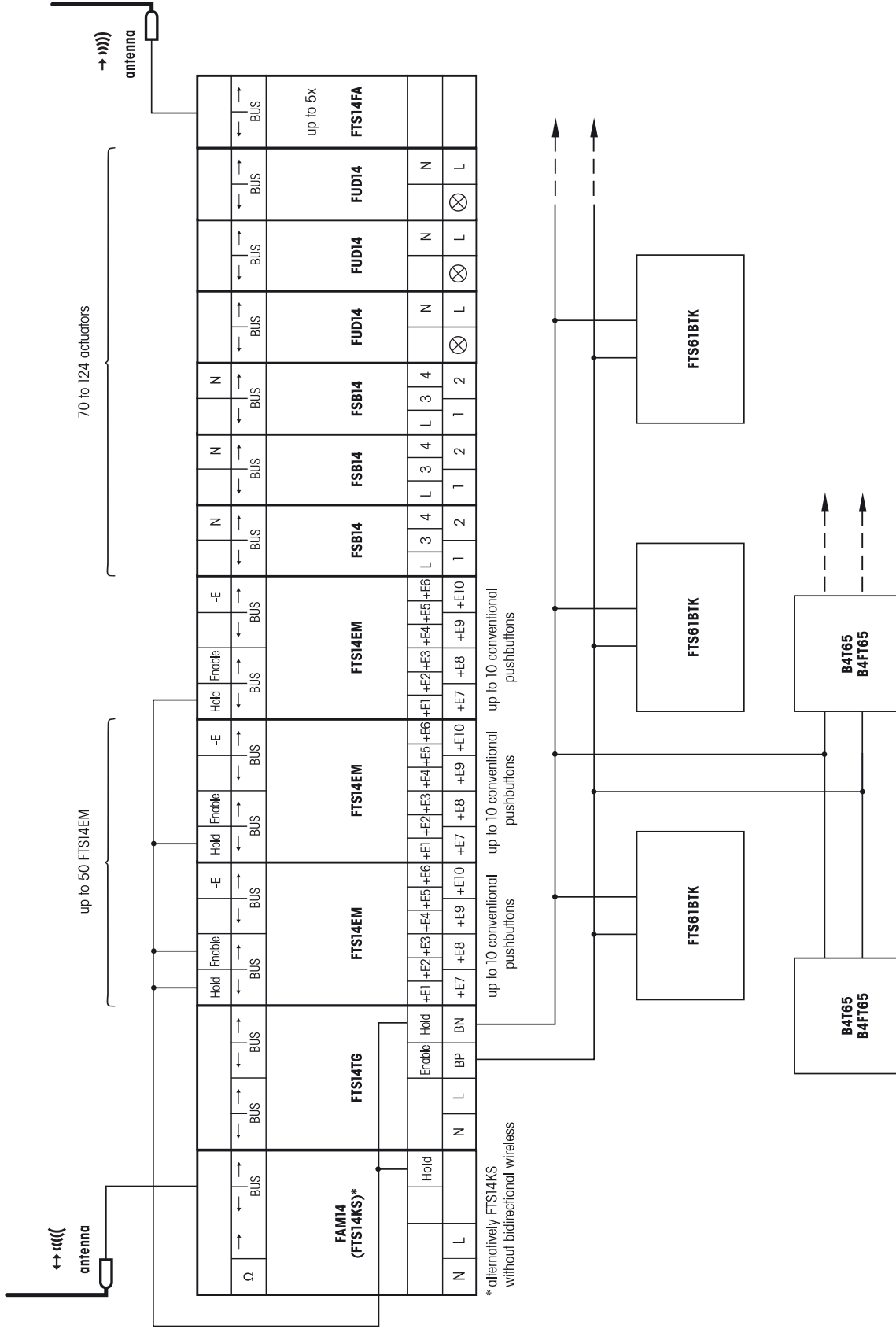

\* alternatively FTS14KS without bidirectional wireless

The second terminator which is included in the FAM14 respectively FTS14KS has to be plugged to the last bus participant. Additional actuator setting options with the PCT14 PC tool for conventional pushbuttons. Up to 30 bus pushbuttons B4T65 or B4FT65 and decentralised bus pushbutton couplers FTS61BTK with 4 pushbutton inputs can be connected with a pushbutton gateway FTS14TG. A simple 2-wire circuit supplies the bus pushbutton coupler with power and also pushbutton information will be transmitted. The topology of the 2-wire connection can be chosen arbitrarily here.