

THE HOME OF INNOVATION.

*Eltako*

# THE RIGHT LIGHT FOR EVERY ROOM WITH ELTAKO DIMMER SWITCHES.

**UNIVERSAL DIMMER SWITCHES, CAPACITY ENHANCER,  
1-10V CONTROLLERS AND AND ROTARY DIMMERS**

SET THE MOOD AND REDUCE ENERGY COSTS AT THE SAME TIME – A FASCINATING COMBINATION FOR INCANDESCENT LAMPS, HALOGEN LAMPS AND LED LAMPS.

**PRODUCTS AND PRICES 2021**

*Eltako*

PROFESSIONAL  
**STAN  
DARD**

# SELECTION TABLE FOR UNIVERSAL DIMMER SWITCHES, CAPACITY ENHANCER AND 1-10 V CONTROLLERS

## THE ENERGY SAVERS



Set the mood and reduce energy costs at the same time - a fascinating combination for incandescent lamps, halogen lamps and LED lamps. The dimming of lamps in combination with soft ON and soft OFF, prolongs their lifetime considerably. This applies also to the infinitely dimmable energy saving lamps. Only universal dimmers with the marking R, L, C recognize automatically the connected load

and adjust their dimming function accordingly. Other dimmers have to be exchanged if lamps with other kind of loads are used later.

Only universal dimmer switches with the added ESL marking and added LED marking have the associated comfort settings.

Page	3	4	5	6	7	9	10	11	12	13	14	15	16	17	18	19	20	21	22	23		
	Piktogramme	EUD12NPN-UC	EUD12D-UC	EUD12F	EUD12DK/800W-UC	LUD12-230V	MOD12D-UC	MFZ12PMD-UC	SDS12/1-10V	SUD12/1-10V	DTD65-230V	DTD65L-230V	DTD55-230V	DTD55L-230V	EUD6INP-230V	EUD6INPL-230V	EUD6INPN-UC	EUD6INPN-230V	EUD6IM-UC	ELD61/12-36V DC	SDS61/1-10V	
Modular device for DIN EN 60715 TH35 rail mounting, number of modules 18 mm each	1	1	1	2	1	1	1	1	1													
Built-in device for installation (e.g. flush-mounting box) and surface mounting											■	■	■	■	■	■	■	■	■	■	■	
Dimming R, L and C loads		■	■	■	■	■ <sup>5)</sup>	L	■	1-10V EVG	1-10V EVG	■	R, C	■	R, C	■	R, C	■	■	■	■	1-10V EVG	
With comfort position for dimmable energy saving lamps ESL		■	■	■	■	■					■	■	■	■			■	■	■	■		
With comfort position for dimmable LEDs		■	■		■	■					■	■	■	■			■	■	■	■	■	
Power MOSFET up to W (nearly unlimited number of switching cycles)		400	400	300	800	400	300	400	—	400 <sup>7)</sup>	300	200	300	200	400	200	400	400	400	400	4A	—
Increase of capacity with capacity enhancer LUD12-230 V			■		■			■														
Zero passage switching		■	■	■	■	■	■	■	■	■	■	■	■	■	■	■	■	■	■	■	■	■
Minimum brightness level adjustable		■	■	■	■	■ <sup>6)</sup>	■	■	■	■ <sup>7)</sup>	■	■	■	■	■	■	■	■	■	■	■	
Dimming speed adjustable		■	■	■		■ <sup>6)</sup>	■	■	■	■ <sup>7)</sup>	■ <sup>9)</sup>	■ <sup>9)</sup>	■ <sup>9)</sup>	■ <sup>9)</sup>	■	■	■ <sup>6)</sup>	■ <sup>6)</sup>		■ <sup>6)</sup>	■	
Universal control voltage 8 to 230 V UC		■	■		■	■ <sup>6)</sup>	■	■	■	■ <sup>6)</sup>												
Supply voltage 230 V		■	■	■	■	■	■	■	■	■	■	■ <sup>1)</sup>	■	■ <sup>1)</sup>	■ <sup>1)</sup>	■ <sup>1)</sup>	■	■	■	■	■	
Low standby loss		■	■	■	■	■	■	■	■	■	■	■	■	■	■	■	■	■	■	■	■	
Glow lamp current (mA) <sup>2)4)</sup>		5	5 <sup>3)</sup>		5 <sup>6)</sup>	5	5															
Central control electrically isolated from the local input			■		■ <sup>6)</sup>	■	■	■	(■)	■ <sup>6)</sup>												
Switching operation for children's rooms		■	■	■	■ <sup>6)</sup>			■	■ <sup>6)</sup>	■	■	■	■	■	■	■	■	■	■	■	■	
Snooze function		■	■	■	■ <sup>6)</sup>			■	■ <sup>6)</sup>	■	■	■	■	■	■	■	■	■	■	■	■	
Multifunction		■					■		■ <sup>6)</sup>									■				

\* EVG = electronic ballast units

<sup>1)</sup> No N connection required.

<sup>2)</sup> Applies to glow lamps with 170 V ignition voltage, for glow lamps with 90 V ignition voltage approx. 1/2 glow lamp current.

<sup>3)</sup> Depends on the set function.

<sup>4)</sup> Will automatically be switched on from 110 V control voltage.

<sup>5)</sup> Same load as main dimmer switch or separate R, L or C load, depending on circuit.

<sup>6)</sup> This specification refers to EUD12D, which is connected in series.

<sup>7)</sup> This specification refers to the connected EUD12D or LUD12 depending on the selected mode.

<sup>8)</sup> Minimum brightness level or dimming speed adjustable.

<sup>9)</sup> Rotation speed determines the dimming speed.

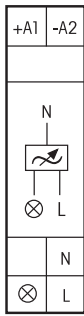

# EUD12NPN-UC



**Universal dimmer switch. Power MOSFET up to 400 W. Automatic lamp detection. Standby loss 0.1 watt only. With adjustable minimum or maximum brightness and dimming speed. With switching operation for children's rooms and snooze function.**

Modular device for DIN EN 60715 TH35 rail mounting. 1 module = 18 mm wide, 58 mm deep. Universal dimmer switch for lamps up to 400 W, depending on ventilation conditions, dimmable energy saving lamps (ESL) and dimmable 230 V LED lamps are also dependent on the lamp electronics. **Zero passage switching with soft start and soft OFF to protect lamps.** **Universal control voltage input 8 to 230 V UC**, electrically isolated from the 230 V supply voltage and switching voltage. No minimum load required.

Short-time control commands switch on/off, permanent control varies the brightness to the maximum level. An interruption of control changes the direction of dimming. The setting of the brightness level is stored after switching off. In case of a power failure the switching position and the brightness level are stored. If applicable the dimmer will be switched on at the stored brightness level after the supply voltage is recovered.

Glow lamp current up to 5 mA starting at 110 V. Automatic electronic overload protection and over-temperature switch-off. The LED below the top rotary switch on the front shows control commands. It starts blinking after 15 seconds if a pushbutton is inhibited.

**The upper rotary switch** determines the operation, whether the automatic lamp detection or special comfort positions should act:

**AUTO allows the dimming of all light species.**

**EC1** is a comfort position for energy saving lamps which must be switched on with increased power dependent on the construction, so they will also switch on again safely in cold condition when dimmed down.

**EC2** is a comfort position for energy saving lamps which will not be switched on again when dimmed down dependent on the construction. Memory is switched off in this position.

**LC1** is a comfort position for dimmable 230 V LED lamps which are not being dimmed down enough when set to AUTO (trailing phase angle) dependent on the construction and must therefore be forced to leading phase angle.

**LC2 and LC3** are comfort positions for dimmable 230 V LED lamps like LC1, but with different dimming curves. **In positions EC1, EC2, LC1, LC2 and LC3 no inductive (wound) transformers should be used.** In addition, the maximum number of dimmable LED lamps can be lower than in the AUTO position dependent on the construction.

The minimum brightness level (completely dimmed down) or the maximum brightness level (completely dimmed up) is adjustable with the **middle % rotary switch**.

The dimming speed can be adjusted **with the lower dimming speed rotary switch**.

The duration of soft start and soft OFF is changed simultaneously.

**With special switching operation for children's rooms:** If the light is switched on by holding down the pushbutton, it starts at the lowest brightness level after approx. 1 second and dims up slowly as long as the pushbutton is held down without modifying the last stored brightness level.

**Snooze function:** With a double impulse the lighting is dimmed down from the current dimming position to the minimum brightness level and switched off. The current dimming position as well as the adjustable minimum brightness level determine the dimming time (max. = 60 minutes) which can be reduced as required. It can be switched off at any time by short-time control commands during the lighting is dimmed down. Holding down the pushbutton during the dimming down process dims up and stops the snooze function.

Mixing of L loads (inductive loads, e.g. wound transformers) and C loads (capacitive loads, e.g. electronic transformers) is not permitted. R loads (ohmic loads, e.g. 230 V incandescent lamps and halogen lamps) may be added anytime.

**Mixing of L loads and C loads** is possible with the dimmer switch **EUD12D** (page 4) in connection with capacity enhancer **LUD12** (page 7).

## Function rotary switches

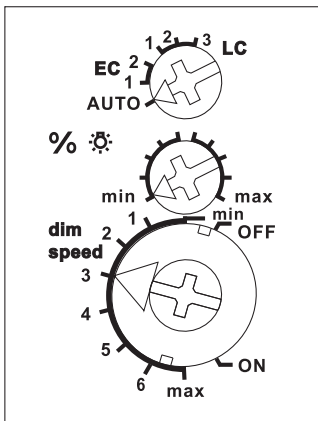

Standard setting ex works.

## Typical connection

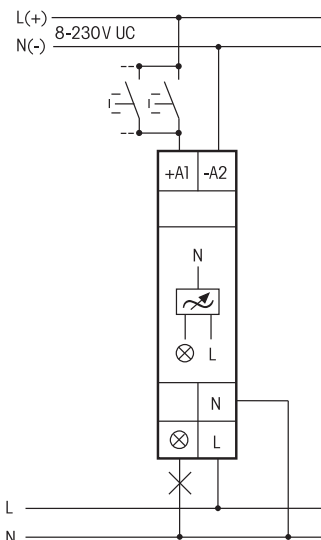

Technical data page 24.  
Housing for operating instructions GBA14,  
see accessoires, chapter Z.

<b>EUD12NPN-UC</b>	Power MOSFET up to 400 W	EAN 4010312107843	<b>59,20 €/pc.</b>
--------------------	--------------------------	-------------------	--------------------

# DIGITAL SETTABLE MULTIFUNCTION UNIVERSAL DIMMER SWITCH EUD12D-UC

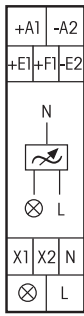

## EUD12D-UC



**Universal dimmer switch. Power MOSFET up to 400 W. Automatic lamp detection. Standby loss 0.3 watt only. With adjustable minimum brightness, maximum brightness and dimming speed. With switching operation for children's rooms and snooze function.**

Modular device for DIN EN 60715 TH35 rail mounting. 1 module = 18 mm wide, 58 mm deep.

Universal dimmer switch for lamps up to 400 W, depending on ventilation conditions, dimmable energy saving lamps (ESL) and dimmable 230 V LED lamps are also dependent on the lamp electronics.

**Up to 3600 W with capacity enhancers LUD12-230V** (description page 7) at the terminals X1 and X2.

Universal control voltage 8 to 230 V UC and additionally the universal voltage control inputs 8 to 230 V UC central ON and central OFF. The control inputs are electrically isolated from the supply voltage and switching voltage. **Zero passage switching with soft start and soft OFF to protect lamps.** In case of a power failure the switching position and the brightness level are stored. If applicable the dimmer will be switched on at the stored brightness level after the supply voltage is recovered. From 110 V control voltage glow lamp current up to 5 mA (not for DSD). Automatic electronic overload protection and over-temperature switch-off. The functions and times are entered using the MODE and SET keys as described in the operating manual and indicated on the LC display. A keylock function is provided.

**You can dim all lamp types in automatic mode settings EUD, DSD, Udo, STS, MIN, MMX, CG and R.**

**EUD** = Universal dimmer switch with settings for dimming speed, minimum brightness, maximum brightness, memory and Soft ON/OFF as well as choice of priority for central control. ESL and LED is settable. Short-time control commands switch on/off, permanent control varies the brightness to the maximum level. A interruption of control changes the direction of dimming.

**ESL** is a convenience setting for energy saving lamps which must be switched on at high voltage for design reasons so that they can also be switched back on cold in dimmed state. Memory must be switched off on energy saving lamps which cannot be switched back on in dimmed state for design reasons.

**LED** is a convenience setting for dimmable 230 V LED lamps which cannot be dimmed down far enough in automatic mode (phase cut-off) for design reasons and must therefore be forced to phase control. There is a choice of 3 dimming curves. **No inductive (wound) transformers may be used in ESL and LED settings.** In addition the maximum number of lamps may be lower than in automatic mode for design reasons.

**Switching operation for children's rooms:** If the light is switched on by holding down the pushbutton, it starts at the lowest brightness level after approx. 1 second and dims up slowly as long as the pushbutton is held down without modifying the last stored brightness level.

**Snooze function:** With a double impulse the lighting is dimmed down from the current dimming position to the minimum brightness level and switched off. The current dimming position as well as the adjustable minimum brightness level determine the dimming time (max. = 60 minutes) which can be reduced as required. It can be switched off at any time by short-time control commands during the lighting is dimmed down. Holding down the pushbutton during the dimming down process dims up and stops the snooze function.

**DSD** = Same as universal dimmer switch EUD but also comprising activation via two direction switches on the universal voltage control inputs 8..230 V UC.

**Udo** = Same as universal dimmer switch EUD but also comprising setting for a time delay from 1 to 99 minutes. Switch-off early warning at the end by dimming is selectable and adjustable from 1 to 3 minutes.

**STS** = Staircase time switch with switchable switch-off early warning by dimming. With pump and permanent light by pushbutton. Time adjustable from 1 to 99 minutes. Switch-off early warning (no flickering) by dimming is adjustable from 1 to 3 minutes. Also for dimmable energy saving lamps ESL and 230 V LED lamps.

**MIN** = Universal dimmer switch, switches when control voltage is applied to the minimum brightness setting. Maximum brightness is dimmed during the set dim time from 1 to 99 minutes. When the control voltage is interrupted, the device is switched off immediately, even during the dim time. **MMX** = Same function as for **MIN**; when the control voltage is interrupted, dimming still continues until the set minimum brightness is reached. Then the device is switched off. **CG** = Clock with adjustable switch on/off times from 0.1 to 9.9 seconds. The maximum brightness is adjustable from 3 to 99%. **R** = Switching relay with setting for Soft ON/OFF from 0.1 to 9.9 seconds. The maximum brightness is adjustable from 3 to 99%. **ON** = permanent ON. **OFF** = permanent OFF.

**The dim position in % or the time lapse in minutes is indicated in the middle of the display.** The expired, resettable switch-on time is indicated at the bottom of the display. Display menu guidance including language selection (German, English, French, Italian or Spanish) is described in the supplied operating instructions.

### Typical connections

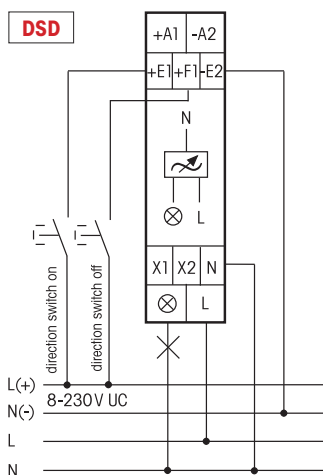
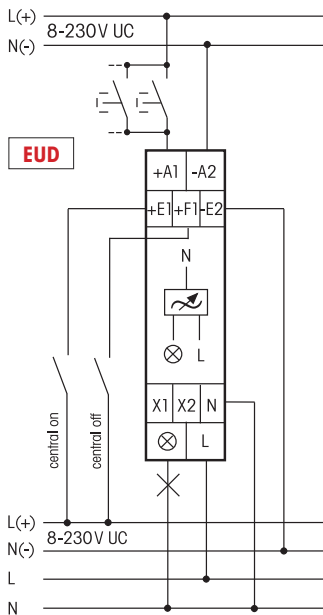

Technical data page 24.

Housing for operating instructions GBA14, see accessories, chapter Z.

<b>EUD12D-UC</b>	Power MOSFET up to 400 W	EAN 4010312109489	<b>71,10 €/pc.</b>
------------------	--------------------------	-------------------	--------------------

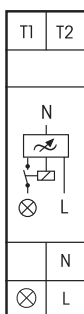

# EUD12F



**Universal dimming switch. Power MOSFET up to 300 W. Automatic lamp detection. Standby loss 0.1 watt only. With adjustable minimum brightness and dimming speed. With switching operation for children's rooms and snooze function.**

Modular device for DIN EN 60715 TH35 rail mounting. 1 module = 18 mm wide, 58 mm deep. Universal dimmer switch for lamps up to 300 W, depending on ventilation conditions, dimmable energy saving lamps (ESL) and dimmable 230 V LED lamps are also dependent on the lamp electronics.

**Zero passage switching with soft start and soft OFF to protect lamps.**

Supply voltage and switching voltage 230 V.

Short-time control commands switch on/off, permanent control varies the brightness to the maximum level.

An interruption of control changes the direction of dimming.

The setting of the brightness level is stored after switching off.

In case of a power failure the switching position and the brightness level are stored.

If applicable the dimmer will be switched on at the stored brightness level after the supply voltage is recovered.

Automatic electronic overload protection and over-temperature switch-off.

**With integrated switching-off relay for the mains disconnection of switched circuits.**

The control pushbutton(s) of the room are connected via low voltage control wires to the terminals T1 and T2 of the EUD12F (field-free internal DC voltage). The permanent power supply must be connected directly to a phase conductor **ahead** of the mains disconnection relay FR12-230V. Due to this, the complete function remains but the leads to the lamps is disconnected by means of the switching-off relay. A glow lamp current is not permitted.

The minimum brightness level (completely dimmed down) can be adjusted with **the upper rotary switch** % ⚙️, e.g. for dimmable energy saving lamps.

**You can dim all lamp types in automatic mode.**

**Use the lower dimming speed rotary switch** to set the dimming speed in seven steps in automatic mode.

**+ESL** is a convenience setting for energy saving lamps which must be switched on at high voltage for design reasons so that they can also be switched back on cold in dimmed state.

**-ESL** is a convenience setting for energy saving lamps which cannot be switched back on in dimmed state for design reasons.

This is why memory is switched off in this position. No inductive (wound) transformers may be used in +ESL and -ESL settings. In addition the maximum number of dimmable energy saving lamps may be lower than in automatic mode for design reasons.

**With special switching operation for children's rooms:** If the light is switched on by holding down the pushbutton, it starts at the lowest brightness level after approx. 1 second and dims up slowly as long as the pushbutton is held down without modifying the last stored brightness level.

**Snooze function:** With a double impulse the lighting is dimmed down from the current dimming position to the minimum brightness level and switched off. The current dimming position as well as the adjustable minimum brightness level determine the dimming time (max. = 60 minutes) which can be reduced as required. It can be switched off at any time by short-time control commands during the lighting is dimmed down. Holding down the pushbutton during the dimming down process dims up and stops the snooze function.

Mixing of L loads (inductive loads, e.g. wound transformers) and C loads (capacitive loads, e.g. electronic transformers) is not permitted. R loads (ohmic loads, e.g. 230 V incandescent lamps and halogen lamps) may be added anytime.

**Mixing of L loads and C loads** is possible with the dimmer switch **EUD12D** (page 4) in connection with capacity enhancer **LUD12** (page 7).

**Function rotary switches**

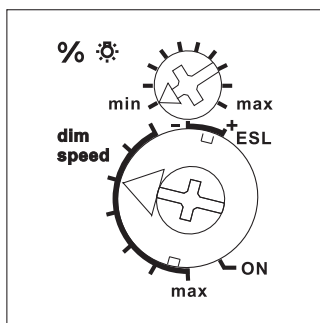

Standard setting ex works.

**Typical connection**

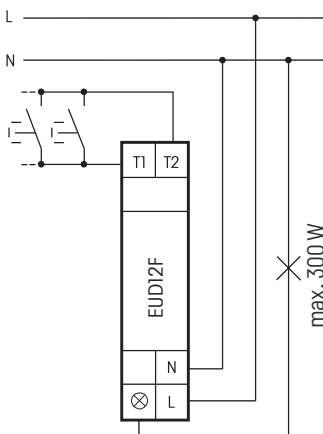

Technical data page 24.  
Housing for operating instructions GBA14,  
see accessoires, chapter Z.

<b>EUD12F</b>	Power MOSFET 300 W and switching-off relay	EAN 4010312108086	<b>71,10 €/pc.</b>
---------------	--	-------------------	--------------------

**UNIVERSAL DIMMER SWITCH WITH ROTARY KNOB EUD12DK/800W-UC**

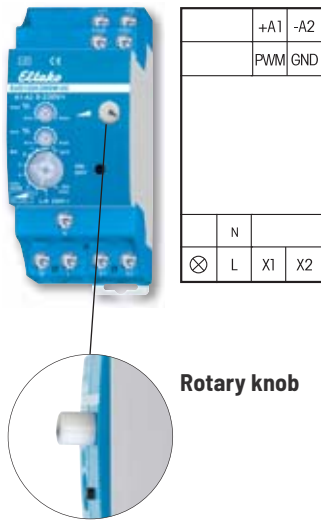

**Rotary knob**

# EUD12DK/800W-UC



**Universal dimmer switch with rotary knob, Power MOSFET up to 800 W. Automatic lamp detection. Standby loss 0.2 watt only. With adjustable minimum and maximum brightness.**

Modular device for DIN EN 60715 TH35 rail mounting. 2 modules = 36 mm wide, 58 mm deep. Universal dimmer switch for lamps up to 800 W, depending on ventilation conditions, dimmable energy saving lamps (ESL) and dimmable 230 V LED lamps are also dependent on the lamp electronics.

**Up to 3600W with capacity enhancers LUD12** at the terminals X1 and X2.

**Zero passage switching with soft start and soft OFF to protect lamps.**

**Universal control voltage input 8 to 230 V UC**, electrically isolated from the 230 V supply voltage and switching voltage. No minimum load required.

**Alternatively, PWM control with 10-24 V DC at the PWM and GND connections.**

The setting of the brightness level is stored after switching off (Memory).

In case of a power failure the switching position and the brightness level are stored.

If applicable the dimmer will be switched on at the stored brightness level after the supply voltage is recovered.

Automatic electronic overload protection and over-temperature switch-off.

**Maximum brightness (fully dimmed up) is adjustable using the upper % rotary switch.**

**Use the middle % rotary switch** to set the minimum brightness (fully dimmed down).

**The lower rotary switch** sets the operating mode:

**ON:** Permanent ON at maximum brightness.

**Pos. 1** is an AUTO position and allows the dimming of all lamp types. Switch on and off using pushbutton on the device and/or pushbutton connected to +A1/-A2. Dimming via rotary knob.

**Pos. 2** is a comfort setting for dimmable 230 V LED lamps which cannot be dimmed down far enough on AUTO (phase cut-off) due to the design and must therefore be forced at phase control. Switch on and off using pushbutton on the device and/or pushbutton connected to +A1/-A2. Dimming via rotary knob.

**Pos. 3** is a comfort setting for energy saving lamps which must be switched on at a higher voltage so that they can be safely switched on cold when they are dimmed down. Switch on and off using pushbutton on the device and/or pushbutton connected to +A1/-A2. Dimming via rotary knob.

**Pos. 4** is an AUTO position and allows the dimming of all lamp types. Switch on and off using switch connected to +A1/-A2. Dimming via rotary knob.

**Pos. 5** is a comfort setting for dimmable 230 V LED lamps which cannot be dimmed down far enough on AUTO (phase cut-off) due to the design and must therefore be forced at phase control. Switch on and off using switch connected to +A1/-A2. Dimming via rotary knob.

**Pos. 6** is a comfort setting for energy saving lamps which must be switched on at a higher voltage so that they can be safely switched on cold when they are dimmed down. Switch on and off using switch connected to +A1/-A2. Dimming via rotary knob.

**Pos. 7** is an AUTO position and allows the dimming of all lamp types. Switch on and off and dimming with PWM activation.

**Pos. 8** is a comfort setting for dimmable 230 V LED lamps which cannot be dimmed down far enough on AUTO (phase cut-off) due to the design and must therefore be forced at phase control. Switch on and off and dimming with PWM activation.

**In positions 2, 3, 5, 6 and 8 no inductive (wound) transformers should be used.**

**OFF:** Permanent OFF.

**The LED** under the upper rotary switch lights up when the lamp is switched on.

**Function rotary switches**

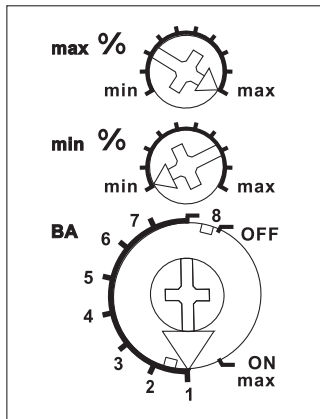

Standard setting ex works.

**Typical connection**

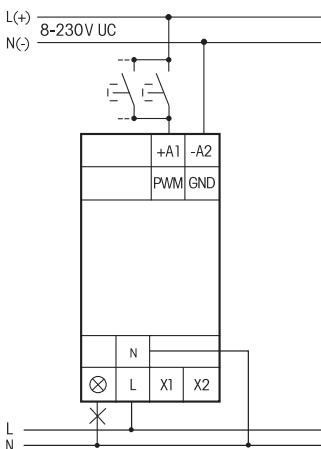

Technical data page 24.  
Housing for operating instructions GBA14,  
see accessoires, chapter Z.

<b>EUD12DK/800W-UC</b>	Universal dimmer switch, Power MOSFET up to 800 W	EAN 4010312109656	<b>69,20 €/pc.</b>
------------------------	---	-------------------	--------------------



# LUD12-230V



**Capacity enhancer for universal dimmer switches. Power MOSFET up to 400 W. Standby loss 0.1 watt only.**

Modular device for DIN EN 60715 TH35 rail mounting. 1 module = 18 mm wide, 58 mm deep. Capacity enhancers LUD12-230V can be connected to the universal dimmer switches EUD12D, SUD12 (1-10 V input) and the multifunction time relay MFZ12PMD. By this the switching capacity for **one lamp** will be increased up to 200 W or **alternatively for additional lamps** up to 400 W per each capacity enhancer. Dimmable energy saving lamps and dimmable 230 V LED lamps are also dependent on the lamp electronics. Both switching modes for increase of capacity can be executed simultaneously. Automatic lamp detection in the "Capacity increase **with additional lamps**" setting. Supply voltage 230 V.

Automatic electronic overload protection and over-temperature switch-off. In the mode "Increase of capacity with additional lamps" the kind of load of a capacity enhancer LUD12-230V can vary from the kind of load of the universal impulse dimmer switch. **Therefore it is possible to mix L loads and C loads.**

### Function rotary switch

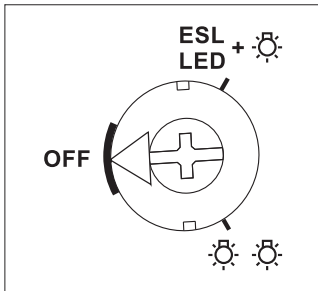

Standard setting ex works.

Standard setting ex works. The switching mode **"one lamp"** (☀️) or **"additional lamps"** (☀️☀️) is set with a rotary switch on the front.

**This setting must be same as the actual installation, otherwise there is a risk of destruction of the electronics.**

Alternative setting for ESL and 230 V LED when the universal dimmer switch in operated in the ESL or LED comfort settings. See page 8.

Technical data page 24.  
Housing for operating instructions GBA14, see accessoires, chapter Z.

### Increase of capacity for one lamp (☀️), ESL and LED see next page

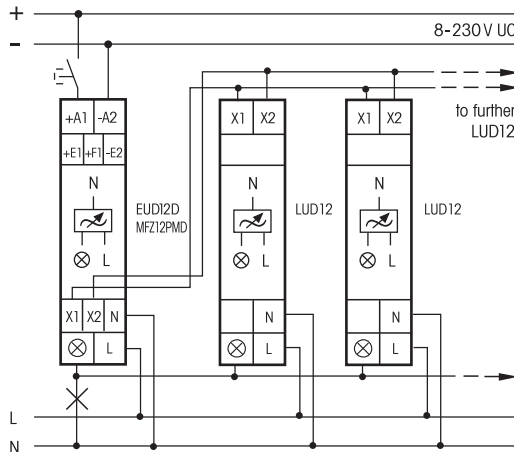

**EUD12D and MFZ12PMD:**  
1.-9. LUD12 + up to 200 W each

### Increase of capacity with additional lamps (☀️☀️), ESL and LED see next page

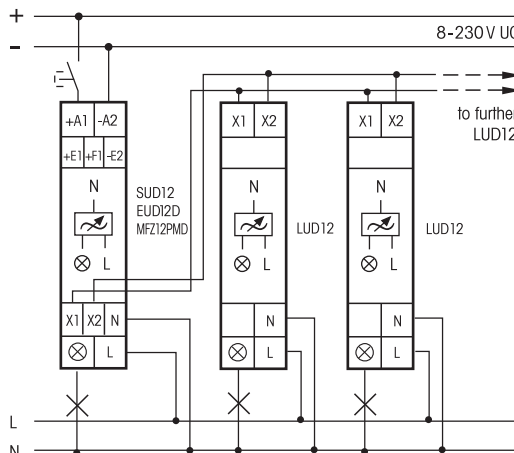

**EUD12D, SUD12 and MFZ12PMD:**  
1.-8. LUD12 + up to 400W each

<b>LUD12-230V</b>	Power MOSFET up to 400 W	EAN 4010312107867	<b>64,10 €/pc.</b>
-------------------	--------------------------	-------------------	--------------------

# LUD12-230V



## Function rotary switch

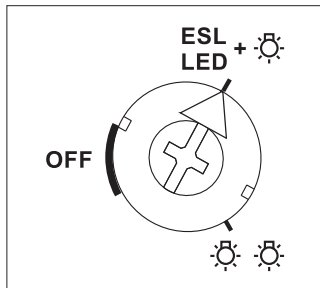

Standard setting ex works.

This setting must be made on the front panel of ESL and 230 V LED lamps if the universal dimmer switch is operated in the ESL or LED comfort settings. Also for capacity increase with additional lamps.

**Otherwise there is a risk of destruction of the electronics.**

Technical data page 24.  
Housing for operating instructions GBA14,  
see accessoires, chapter Z.

Capacity increase with capacity enhancer LUD12 for ESL dimmable energy saving lamps and dimmable 230 V LED lamps in the ESL and LED comfort settings.

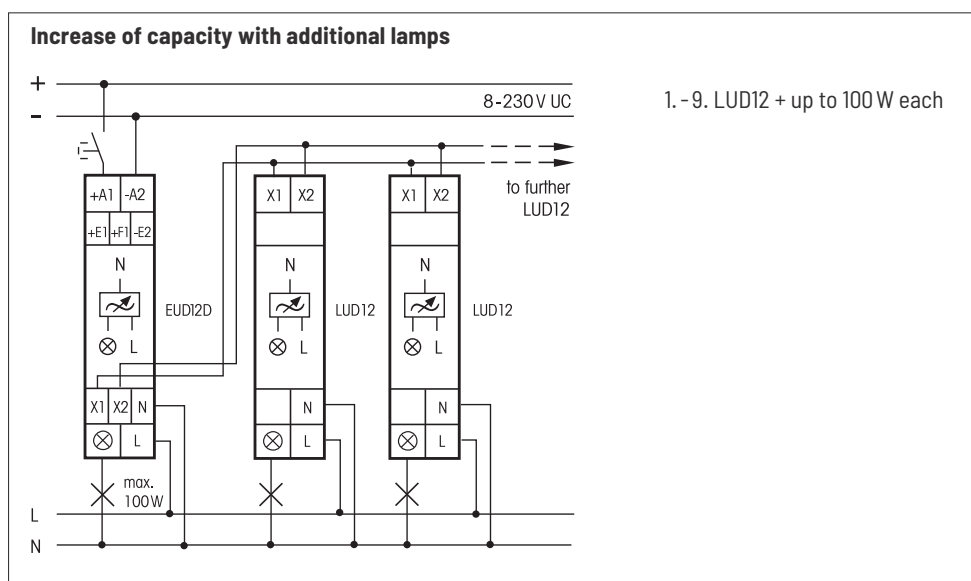
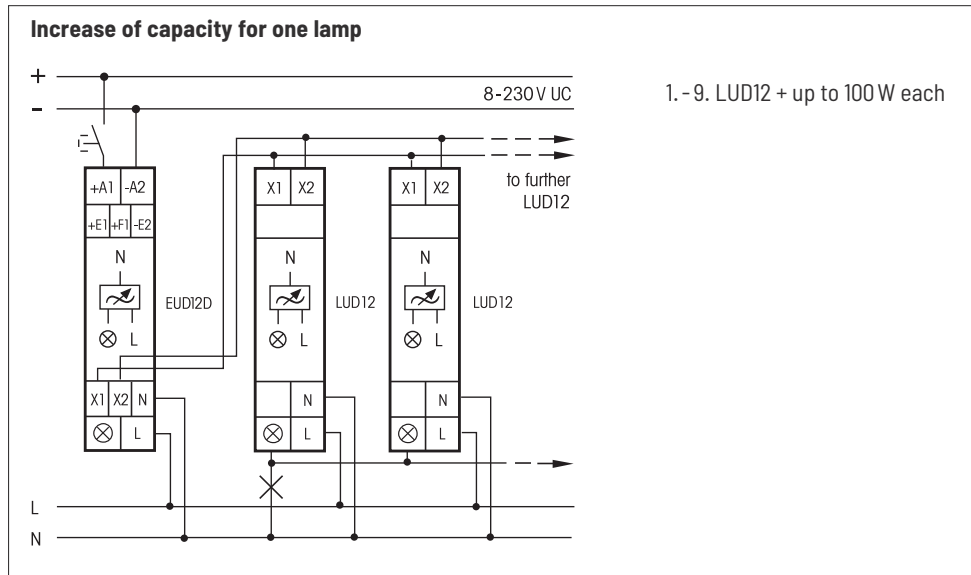

<b>LUD12-230V</b>	Power MOSFET up to 400 W	EAN 4010312107867	<b>64,10 €/pc.</b>
-------------------	--------------------------	-------------------	--------------------





# MOD12D-UC

**Power MOSFET up to 300 W. Standby loss 0.3 watt only. Minimal speed, maximum speed and dimming speed are adjustable.**

Modular device for DIN EN 60715 TH35 rail mounting.

1 module = 18 mm wide, 58 mm deep.

Motor dimmer with phase control for L loads up to 300 W, depending on ventilation conditions.

Only 1 fan motor should be connected.

Universal control voltage 8 to 230 V UC and additionally the universal voltage control inputs 8 to 230 V UC central ON and central OFF. The control inputs are electrically isolated from the 230 V supply voltage and switching voltage.

**Switching in zero crossing and switch-on at increased speed.**

If there is a power failure, the switch position and the speed level are saved. The device can be switched on when the power supply is restored.

Automatic electronic overload protection and over-temperature switch-off.

Enter the 6 functions and times using the MODE and SET keys as described in the operator manual.

The functions and times are indicated in the LC display. Other features include language selection and keylock.

The total switch-on time is added and indicated in the bottom line of the display. It can be reset to zero. The top line shows the parameters during the setting procedure and the active function in service. The left arrow indicates the switch position 'ON' and the right arrow shows the keylock function when applied. During the setting procedure, the middle line shows the parameters set. In service, the middle line indicates the speed between 10 and 99 for the MOD and DSD functions or the remaining time in minutes for the Udo and ODT functions.

**MOD** = Motor dimmer with settings for dimming speed DSP, minimum speed MI%, maximum speed MA%, memory function MEM+ and selection of the central control inputs ON and/or OFF when activated or deactivated. Short commands switch on/off, permanent activation changes speed. An interruption in activation changes the dimming direction.

**DSD** = Motor dimmer with activation with two direction buttons for dimming direction. Setting the dimming speed DSP, minimum speed MI%, maximum speed MA% and memory function MEM+. When activation takes place via +E1, a short command switches on. Permanent activation dims up to maximum speed. A double-click immediately dims to maximum speed. When activation takes place via +F1, a short command switches off. Permanent activation dims down to minimum speed. No central control function.

**Udo** = Motor dimmer as for MOD function with manual on/off. In addition, a time delay time TIM can be set from 1 to 99 minutes. When the time delay expires, the device switches off. Central ON has priority over Central OFF.

**ODT** = Motor dimmer with run-on switch function with adjustable speed SP%, response lag AV adjustable from 1 to 99 minutes and time delay RV adjustable from 1 to 99 minutes. When the control voltage is applied, the device switches on after the AV time expires. When the control voltage cuts off, the RV time begins. When the RV time expires, the device switches off.

No central control function.

**ON** = Permanent ON at maximum speed, **OFF** = Permanent OFF.

Press MODE and SET briefly and simultaneously to activate the keylock. Then press SET to confirm the flashing LCK. Press MODE and SET simultaneously for 2 seconds to deactivate keylock. Then press SET to confirm the flashing UNL.

**Typical connections**

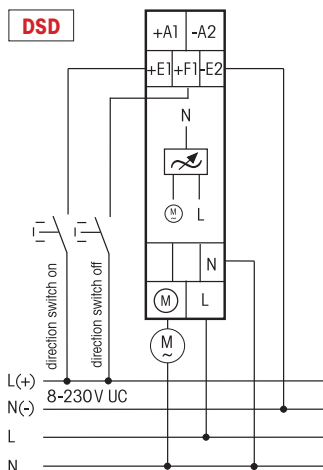
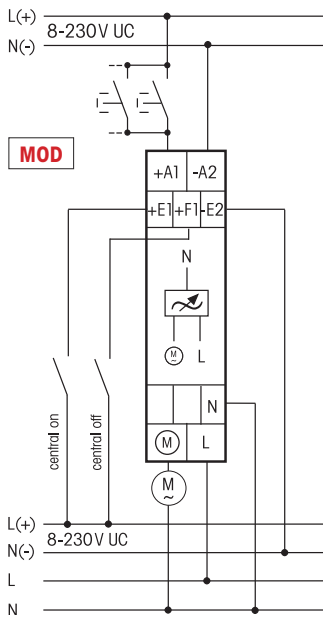

Technical data page 24.  
Housing for operating instructions GBA14,  
see accessoires, chapter Z.

<b>MOD12D-UC</b>	Power MOSFET up to 300 W	EAN 4010312109526	<b>71,10 €/pc.</b>
------------------	--------------------------	-------------------	--------------------

## FULLY ELECTRONIC MULTIFUNCTION TIME RELAY MFZ12PMD-UC WITH 18 FUNCTIONS

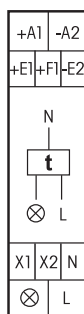

## MFZ12PMD-UC



**Power MOSFET with almost unlimited number of circuits up to 400 W. Automatic lamp detection. Standby loss 0.3 watt only. Dim down to minimum brightness and up to maximum brightness and Soft ON / Soft OFF are also adjustable for lamp circuit.**

Modular device for DIN EN 60715 TH35 rail mounting. 1 module = 18 mm wide, 58 mm deep. Digitally adjustable and fully electronic multifunction time relay for lamps up to 400 W dependent on ventilation conditions. Dimmable energy saving lamps (ESL) and dimmable 230V LED lamps are also dependent on the lamp electronics.

If **minimum brightness** is not set to 0, the circuit is not switched off but dimmed down to the set percentage.

**Up to 3600 W with capacity enhancers LUD12-230V** (description page 7) at the terminals X1 and X2. Universal control voltage 8 to 230 V UC and additionally the universal voltage control inputs 8 to 230 V UC central ON and central OFF. The control inputs are electrically isolated from the supply voltage and switching voltage.

### Zero passage switching to protect lamps.

Glow lamp current up to 5 mA starting at 110 V.

Automatic electronic overload protection and overtemperature switch-off.

Enter both the functions and the times using the two buttons MODE and SET. The functions and times are indicated digitally on an LC display. The time can be set by entering all values within the preselected time scale (0.1 to 9.9 or 1 to 99 seconds, minutes or hours). The longest time is 99 hours. This permits 600 time settings. The time(s) entered is (are) permanently displayed digitally.

**Settable functions** (description page 13-11): **RV** = release delay, **AV** = operate delay, **AV+** = additive operate delay, **TI** = clock generator starting with impulse, **TP** = clock generator starting with pause, **IA** = impulse-controlled operate delay, **IF** = pulse shaper, **EW** = fleeting NO contact, **AW** = fleeting NC contact, **EAW** = fleeting NO contact and fleeting NC contact, **ARV** = operate and release delay, **ARV+** = additive operate and release delay, **ES** = impulse switch, **SRV** = release-delay impulse switch, **ESV** = impulse switch with release delay and switch-off early-warning function, **ER** = relay, **ON** = permanent ON, **OFF** = permanent OFF. With TI, TP, IA, EAW, ARV and ARV+ functions, a different second time can be entered also with different time ranges.

**Setting the times and functions:** The LCD component to be changed is selected by pressing the MODE key. The component accessed flashes. Press the SET key to change the component accessed. This may be the function, the time ranges, time T1 or time T2 (on TI, TP, IA, EAW, ARV and ARV+ only). Pressing the MODE key terminates each input. Once the time has been set with MODE, no more components are flashing. The timing relay is now ready to operate. Press the MODE key again to restart the input cycle. All the entered parameters are retained if they are not changed using SET. 25 sec. after the last operation and if the component still flashes the input cycle is automatically terminated and the previously made changes lapse.

**Setting additional parameters valid for all functions:** when you press the MODE button for longer than 2 seconds, you access the submenu. Press the SET button to select the parameter you want to change. Then confirm by pressing MODE. Press SET to enter the parameter and confirm by pressing MODE. After the 'LED' submenu, you return automatically to the main menu.

**MIN** = Minimum brightness in OFF state settable to 0 and from 10 to 89 (%), factory setting = 0.

**MAX** = Maximal brightness in ON state settable from 10 to 99 (%), factory setting = 99. MAX must be at least 10 divisions above MIN.

**RMP** = Switch ON/OFF ramp (soft ON and soft ON) adjustable from 0 = 10 ms to 99 = 1 s, factory setting = 0.

**LED** = LED+ for dimmable 230 V LED lamps which cannot be dimmed down far enough in automatic mode (trailing edge control) for design reasons and must therefore be forced by phase control. Enabled by pressing MODE; factory setting = LED without +.

**Functions of the LC display:** if you selected the functions ON or OFF, no time is displayed. Instead an arrow indicates either ON or OFF. In all other functions the set time(s), the function abbreviation and an arrow next to ON and OFF display the switching position. The clock symbol flashes while the set time is elapsing and the remaining time is shown.

**Safety in the event of a power failure:** The set parameters are stored in an EEPROM and are therefore immediately available again when the power supply is restored after a power failure.

### Typical connection

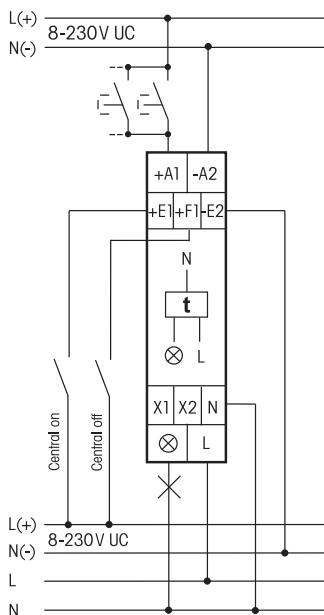

Technical data page 24.  
Housing for operating instructions GBA14,  
see accessories, chapter Z.

MFZ12PMD-UC	Power MOSFET up to 400 W	EAN 4010312601099	70,40 €/pc.
-------------	--------------------------	-------------------	-------------

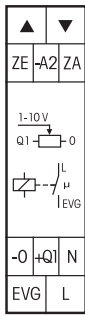

## SDS12/1-10V



**1 NO contact not potential free 600 VA and 1-10 V control output 40 mA. Only 1 watt standby loss. With adjustable minimum brightness and dimming speed. With switching operation for children's rooms and snooze function.**

Modular device for DIN-EN 60715 TH35 rail mounting.  
1 modul = 18 mm wide, 58 mm deep.

**Zero passage switching with soft ON and soft OFF to protect lamps.**

**Also adapted for LED driver with 1-10 V passive interface, without voltage source up to 0.6 mA, above this value an additional voltage source is necessary.**

Universal control voltage 8 to 230 V UC, local and central on/off with same potential.

Supply voltage 230 V electrically isolated.

State-of-the-art hybrid technology combines advantages of nonwearing electronic control with high capacity of special relays.

The brightness level is stored on switch-off (Memory).

In case of a power failure the switch position and the brightness stage are stored and may be switched on when the power supply is restored.

**The minimum brightness (fully dimmed) is adjustable with the upper % rotary switch.**

At the same time, you define whether the children's room function and the snooze function are active (+KI +SL). The dimming speed is adjustable **using the lower dimming speed rotary switch.**

The load is switched on and off by a bistable relay at output EVG (electronic ballast units). Switching capacity for fluorescent lamps or LV halogen lamps with electronic ballast units 600 VA.

**By using a bistable relay coil power loss and heating is avoided even in the on mode.** After installation, wait for short automatic synchronisation before the switched consumer is connected to the mains.

**Either direction pushbuttons can be connected to ▲ ▼ or these terminals are bridged and a push-button is connected as universal pushbutton. As direction pushbutton ▲ is 'switch on and dim up' and ▼ is 'switch off and dim down'. A double click at ▲ triggers the automatic updimming until full brightness with dim speed. A double click at ▼ triggers the snooze function. The children's room function is realized with the pushbutton at ▲.**

**As a universal pushbutton, change the direction by briefly releasing the pushbutton.**

**Switching operation for children's rooms KI (universal pushbutton or direction pushbutton ▲):**

If the light is switched on by holding down the pushbutton, it starts at the lowest brightness level after approx. 1 second and dims up slowly as long as the pushbutton is held down without modifying the last stored brightness level.

**Snooze function SL (universal pushbutton or direction pushbutton ▼):** With a double impulse the lighting is dimmed down from the current dimming position to the minimum brightness level and switched off.

The current dimming position as well as the adjustable minimum brightness level determine the dimming time (max. = 60 minutes) which can be reduced as required. It can be switched off at any time by short-time control commands during the lighting is dimmed down. Holding down the pushbutton during the dimming down process dims up and stops the snooze function.

### Function rotary switches

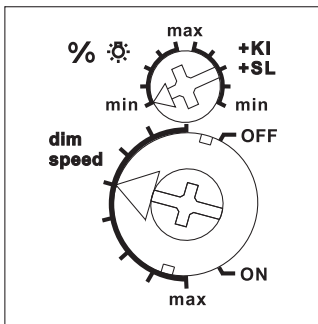

Standard setting ex works.

### Typical connections

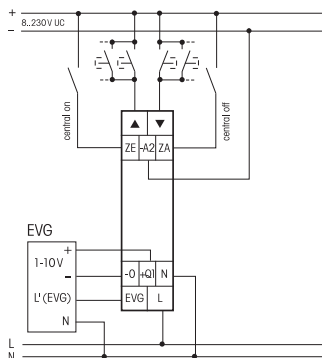

with direction pushbutton

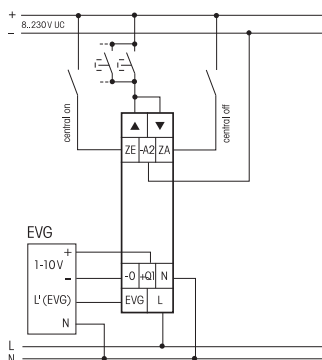

with universal pushbutton

Technical data page 24.  
Housing for operating instructions GBA14,  
see accessories, chapter Z.

SDS12/1-10V	1 NO contact 600 VA	EAN 4010312109403	57,00 €/pc.
-------------	---------------------	-------------------	-------------

## 1-10V CONTROLLER SUD12/1-10V FOR UNIVERSAL DIMMER SWITCHES

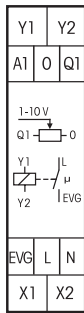

# SUD12/1-10V



**1 NO contact potential free 600 VA and 1-10 V control output 40 mA. Standby loss 0.9 watt only.**

Modular device for DIN-EN 60715 TH35 rail mounting. 1 module = 18 mm wide, 58 mm deep.  
State-of-the-art hybrid technology combines advantages of nonwearing electronic control with high capacity of special relays.

**The controller SUD12 can be used in two different modes:**

## Mode 1-10 V output

In this mode electronic ballast units and transformers with a 1-10V interface up to a total control current of 40 mA can be controlled when connected to an universal dimmer switch EUD12D or MFZ12PMD. The EUD12D or the MFZ12PMD is controlled with pushbuttons at the universal control voltage input locally or centrally. The SUD12 converts the dimmer signals from Y1/Y2 to the 1-10 V output 0/Q1 for the interface.

It switches the electronic ballast with a bistable relay at the output EVG (electronic ballast units). **Zero passage switching to protect contacts.** The switching capacity for fluorescent lamps or low voltage halogen lamps with electronic ballast is up to 600 VA.

**By using a bistable relay coil power loss and heating is avoided even in the on mode.**

The switched load may not be connected to the mains before the short automatic synchronisation after installation has terminated.

**At the same time a directly dimmable lamp can be connected to the dimmer switch EUD12D. Furthermore the dimmer switch EUD12D or MFZ12PMD can be expanded with capacity enhancers LUD12 for directly dimmable lamps as described on page 9-7.**

### Mode 1-10 V output

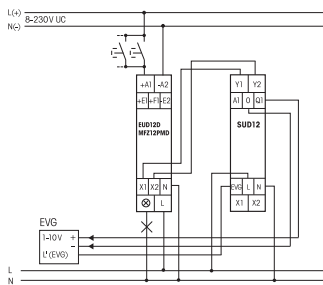

### Mode 1-10 V input

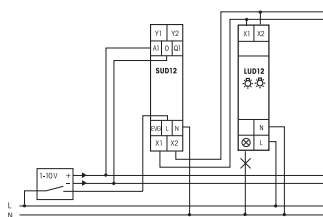

Technical data page 24.  
Housing for operating instructions GBA14,  
see accessoires, chapter Z.

## Mode 1-10 V input

In this mode the output of a 1-10 V controller can be converted at A1/0 into a direct dimming function when connected to a capacity enhancer LUD12 at terminals X1/X2. The closing operation and the opening operation is also carried out externally at L of the SUD12.

**The rotary switch of the LUD12 must be adjusted to the setting  (additional lamps).**

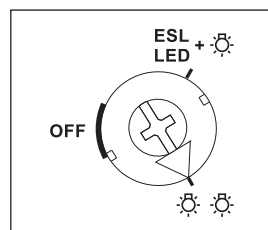

Further capacity enhancers LUD12 in the mode "increase of capacity with additional lamps" can be connected to the controller SUD12 as described on page 9-8.

A 100 K potentiometer for brightness control may also be directly connected to the control input A1/0. If the input A1/0 is disconnected the LUD12 dims to maximum brightness.

<b>SUD12/1-10V</b>	1 NO contact 600 VA	EAN 4010312108116	<b>54,40 €/pc.</b>
--------------------	---------------------	-------------------	--------------------



Function rotary switches

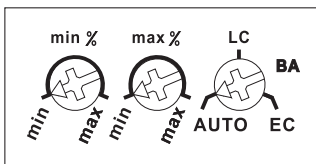

Standard setting ex works.

## DTD65-230V-wg



**Rotary dimmer for single mounting 84 x 84 x 25 mm or mounting into the E-Design65 switching system. Installation depth 33 mm. Universal dimmer switch with rotary knob, Power MOSFET up to 300 W. Automatic lamp detection. With adjustable minimum and maximum brightness. Standby loss 0.14 watt only.**

Universal dimmer switch for lamps up to 300 W, depending on the ventilation conditions. Dimmable energy saving lamps (ESL) and dimmable 230 V LED lamps also depending on the lamp electronics.

**Zero passage switching with soft start and soft OFF to protect lamps.**

Control voltage, supply voltage and switching voltage 230 V. No minimum load required.

The setting of the brightness level is stored after switching off (Memory).

In case of a power failure the switching position and the brightness level are stored. If applicable the dimmer will be switched on at the stored brightness level after the supply voltage is recovered.

Automatic electronic overload protection and over-temperature switch-off.

**Mounting:** screw mounting plate. After the rotary switch setting, pull the red insulating cap and attach the knob. The insulating cap should be remained for future use in the DTD65. Then put up the frame and attach the front panel.

**⚠ Important! Before mounting and removal, always disconnect the power supply!**

Minimum brightness (fully dimmed down) is adjustable using the left % rotary switch.

**Use the middle % rotary switch** to set the maximum brightness (fully dimmed up).

**The right rotary knob** sets the operating mode:

**AUTO** allows the dimming of all lamp types.

**LC** is a comfort position for dimmable 230 V LED lamps which are not being dimmed down enough when set to AUTO (trailing phase angle) dependent on the construction and must therefore be forced to leading phase angle.

**EC** is a comfort position for energy saving lamps which must be switched on with increased power dependent on the construction, so they will also switch on again safely in cold condition when dimmed down.

**In positions EC and LC no inductive (wound) transformers should be used.** In addition, the maximum number of dimmable LED lamps may be lower by design than in the AUTO position.

**Operation:**

**Press the middle of the rotary knob** to switch on with memory value and to switch off and save the current dimming value.

**Turn to the right (clockwise) to dim up.** The turning speed determines the dim-up speed.

If the dimming actuator was switched off to the right at the start of dimming, switch-on is at minimum brightness followed by gradual dim-up. **This is the children's room circuit.**

**When the rotary knob is turned jerkily to the right** - dim-up is rapid to the maximum brightness adjusted.

**Turn to the left (anticlockwise) to dim-down** to the minimum brightness adjusted.

The turning speed determines the dim-down speed.

**When the rotary knob is turned jerkily to the left**, dim-down is rapid to the minimum brightness adjusted.

If the dimming switch was switched off to the left at the start of turning, switch-on is at minimum brightness followed by gradual dim-up by turning to the right.

**Control is also possible using a 230 V control pushbutton in addition to the rotary knob:**

Short commands switch on/off, continuous activation changes brightness up to maximum or minimum value. If you interrupt activation, it changes the dimming direction.

**Children's room circuit with control pushbutton:** Press the control pushbutton for a long time to switch on at minimum brightness, then continue pressing the pushbutton to dim up the lights slowly without changing the last dimming value stored.

**Sleep time with control pushbutton:** A double pulse dims down and switches off the lighting from the current dimming position through to minimum brightness.

The maximum dimming time of 60 minutes is dependent on the current dimming position and the adjusted minimum brightness and can therefore be shortened as required. Tap briefly at any time during dim-down process to switch off. Press long during the dimming-down process to dim up and end the sleep timer.

Technical data page 9-24.

DTD65-230V-wg	Rotary dimmer, pure white glossy	EAN 4010312317426	56,40 €/pc.
---------------	----------------------------------	-------------------	-------------



Function rotary switches

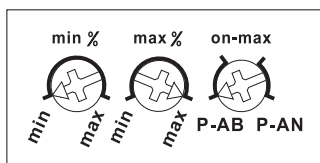

Standard setting ex works.

## DTD65L-230V-wg



Rotary dimmer without N connection for single mounting 84 x 84 x 25 mm or mounting into the E-Design65 switching system. Installation depth 33 mm. Universal dimmer switch with rotary knob, Power MOSFET up to 200 W. With adjustable minimum and maximum brightness. Standby loss 0.5 watt only.

Universal dimmer switch for R and C loads up to 200 watt, depending on ventilation conditions. Dimmable energy saving lamps ESL and 230 V LED lamps in 'trailing edge' mode up to 200 W or up to 40 W in 'leading edge' mode, depending on ventilation conditions.

If 230 V LED lamps are lightly glowing when they are turned off, a GLE base load must be installed parallel to the lamp.

**It is not permitted to connect L loads (inductive loads, like wounded transformers).**

**Zero passage switching with soft start and soft OFF to protect lamps.**

Control voltage, supply voltage and switching voltage 230 V. Minimum load 4 W.

In case of a power failure the switching position and the brightness level are stored. If applicable the dimmer will be switched on at the stored brightness level after the supply voltage is recovered.

Automatic electronic overload protection and over-temperature switch-off.

**Mounting:** screw mounting plate. After the rotary switch setting, pull the red insulating cap and attach the knob. The insulating cap should be remained for future use in the DTD65L. Then put up the frame and attach the front panel.

**⚠ Important! Before mounting and removal, always disconnect the power supply!**

Minimum brightness (fully dimmed down) is adjustable **using the left % rotary switch.**

**Use the middle % rotary switch** to set the maximum brightness (fully dimmed up).

**The right rotary switch** allows to choose the dimming technology: **trailing edge** with memory (**P-AB**), **trailing edge** without memory (**P-AB on-max**), **leading edge** with memory (**P-AN**) or leading edge without memory (**P-AN on-max**).

The adjusted brightness stays saved at turning off if the **memory function** is active. At **on-max function** it turns on always with 100% brightness, by this way ESL can be switched.

**Operation:**

**Press the middle of the rotary knob** to switch on with memory value and to switch off and save the current dimming value.

**Turn to the right (clockwise) to dim up.** The turning speed determines the dim-up speed.

If the dimming actuator was switched off to the right at the start of dimming, switch-on is at minimum brightness followed by gradual dim-up. **This is the children's room circuit.**

**When the rotary knob is turned jerkily to the right** – dim-up is rapid to the maximum brightness adjusted.

**Turn to the left (anticlockwise) to dim-down** to the minimum brightness adjusted.

The turning speed determines the dim-down speed.

**When the rotary knob is turned jerkily to the left**, dim-down is rapid to the minimum brightness adjusted.

If the dimming switch was switched off to the left at the start of turning, switch-on is at minimum brightness followed by gradual dim-up by turning to the right.

**Control is also possible using a 230 V control pushbutton in addition to the rotary knob:**

Short commands switch on/off, continuous activation changes brightness up to maximum or minimum value. If you interrupt activation, it changes the dimming direction.

**Children's room circuit with control pushbutton:** Press the control pushbutton for a long time to switch on at minimum brightness, then continue pressing the pushbutton to dim up the lights slowly without changing the last dimming value stored.

**Sleep time with control pushbutton:** A double pulse dims down and switches off the lighting from the current dimming position through to minimum brightness.

The maximum dimming time of 60 minutes is dependent on the current dimming position and the adjusted minimum brightness and can therefore be shortened as required. Tap briefly at any time during dim-down process to switch off. Press long during the dimming-down process to dim up and end the sleep timer.

Technical data page 24.

DTD65L-230V-wg	Rotary dimmer without N connection, pure white glossy	EAN 4010312317716	56,40 €/pc.
----------------	---	-------------------	-------------



Function rotary switches

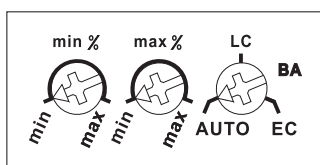

Standard setting ex works.

## DTD55-230V-wg



**Rotary dimmer for single mounting 80 x 80 x 25 mm or mounting into the E-Design55 switching system. Installation depth 33 mm. Universal dimmer switch with rotary knob, Power MOSFET up to 300 W. Automatic lamp detection. With adjustable minimum and maximum brightness. Standby loss 0.14 watt only.**

Universal dimmer switch for lamps up to 300 W, depending on the ventilation conditions. Dimmable energy saving lamps (ESL) and dimmable 230 V LED lamps also depending on the lamp electronics.

**Zero passage switching with soft start and soft OFF to protect lamps.**

Control voltage, supply voltage and switching voltage 230 V. No minimum load required.

The setting of the brightness level is stored after switching off (Memory).

In case of a power failure the switching position and the brightness level are stored. If applicable the dimmer will be switched on at the stored brightness level after the supply voltage is recovered.

Automatic electronic overload protection and over-temperature switch-off.

**Mounting:** screw mounting plate. After the rotary switch setting, pull the red insulating cap and attach the knob. The insulating cap should be remained for future use in the DTD55. Then put up the frame and attach the front panel.

**⚠ Important! Before mounting and removal, always disconnect the power supply!**

Minimum brightness (fully dimmed down) is adjustable **using the left % rotary switch.**

**Use the middle % rotary switch** to set the maximum brightness (fully dimmed up).

**The right rotary knob** sets the operating mode:

**AUTO** allows the dimming of all lamp types.

**LC** is a comfort position for dimmable 230 V LED lamps which are not being dimmed down enough when set to AUTO (trailing phase angle) dependent on the construction and must therefore be forced to leading phase angle.

**EC** is a comfort position for energy saving lamps which must be switched on with increased power dependent on the construction, so they will also switch on again safely in cold condition when dimmed down.

**In positions EC and LC no inductive (wound) transformers should be used.** In addition, the maximum number of dimmable LED lamps may be lower by design than in the AUTO position.

**Operation:**

**Press the middle of the rotary knob** to switch on with memory value and to switch off and save the current dimming value.

**Turn to the right (clockwise) to dim up.** The turning speed determines the dim-up speed.

If the dimming actuator was switched off to the right at the start of dimming, switch-on is at minimum brightness followed by gradual dim-up. **This is the children's room circuit.**

**When the rotary knob is turned jerkily to the right** - dim-up is rapid to the maximum brightness adjusted.

**Turn to the left (anticlockwise) to dim-down** to the minimum brightness adjusted.

The turning speed determines the dim-down speed.

**When the rotary knob is turned jerkily to the left**, dim-down is rapid to the minimum brightness adjusted.

If the dimming switch was switched off to the left at the start of turning, switch-on is at minimum brightness followed by gradual dim-up by turning to the right.

**Control is also possible using a 230 V control pushbutton in addition to the rotary knob:** Short commands switch on/off, continuous activation changes brightness up to maximum or minimum value.

If you interrupt activation, it changes the dimming direction.

**Children's room circuit with control pushbutton:** Press the control pushbutton for a long time to switch on at minimum brightness, then continue pressing the pushbutton to dim up the lights slowly without changing the last dimming value stored.

**Sleep time with control pushbutton:** A double pulse dims down and switches off the lighting from the current dimming position through to minimum brightness.

The maximum dimming time of 60 minutes is dependent on the current dimming position and the adjusted minimum brightness and can therefore be shortened as required. Tap briefly at any time during dim-down process to switch off. Press long during the dimming-down process to dim up and end the sleep timer.

Technical data page 24.

DTD55-230V-wg	Rotary dimmer, pure white glossy	EAN 4010312317785	56,40 €/pc.
---------------	----------------------------------	-------------------	-------------



Function rotary switches

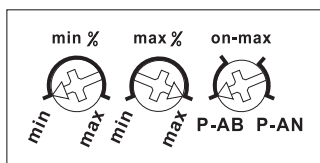

Standard setting ex works.

Technical data page 24.

## DTD55L-230V-wg



**Rotary dimmer without N connection for single mounting 80 x 80 x 25 mm or mounting into the E-Design55 switching system. Installation depth 33 mm. Universal dimmer switch with rotary knob, Power MOSFET up to 200 W. With adjustable minimum and maximum brightness. Standby loss 0.5 watt only.**

Universal dimmer switch for R and C loads up to 200 watt, depending on ventilation conditions. Dimmable energy saving lamps ESL and 230 V LED lamps in 'trailing edge' mode up to 200 W or up to 40 W in 'leading edge' mode, depending on ventilation conditions.

If 230 V LED lamps are lightly glowing when they are turned off, a GLE base load must be installed parallel to the lamp.

**It is not permitted to connect L loads (inductive loads, like wounded transformers).**

**Zero passage switching with soft start and soft OFF to protect lamps.**

Control voltage, supply voltage and switching voltage 230 V. Minimum load 4 W.

In case of a power failure the switching position and the brightness level are stored. If applicable the dimmer will be switched on at the stored brightness level after the supply voltage is recovered.

Automatic electronic overload protection and over-temperature switch-off.

**Mounting:** screw mounting plate. After the rotary switch setting, pull the red insulating cap and attach the knob. The insulating cap should be remained for future use in the DTD55L. Then put up the frame and attach the front panel.

**⚠ Important! Before mounting and removal, always disconnect the power supply!**

Minimum brightness (fully dimmed down) is adjustable **using the left % rotary switch.**

**Use the middle % rotary switch** to set the maximum brightness (fully dimmed up).

**The right rotary switch** allows to choose the dimming technology: **trailing edge** with memory (**P-AB**), **trailing edge** without memory (**P-AB on-max**), **leading edge** with memory (**P-AN**) or leading edge without memory (**P-AN on-max**).

The adjusted brightness stays saved at turning off if the **memory function** is active. At **on-max function** it turns on always with 100% brightness, by this way ESL can be switched.

**Operation:**

**Press the middle of the rotary knob** to switch on with memory value and to switch off and save the current dimming value.

**Turn to the right (clockwise) to dim up.** The turning speed determines the dim-up speed.

If the dimming actuator was switched off to the right at the start of dimming, switch-on is at minimum brightness followed by gradual dim-up. **This is the children's room circuit.**

**When the rotary knob is turned jerkily to the right** - dim-up is rapid to the maximum brightness adjusted.

**Turn to the left (anticlockwise) to dim-down** to the minimum brightness adjusted.

The turning speed determines the dim-down speed.

**When the rotary knob is turned jerkily to the left**, dim-down is rapid to the minimum brightness adjusted.

If the dimming switch was switched off to the left at the start of turning, switch-on is at minimum brightness followed by gradual dim-up by turning to the right.

**Control is also possible using a 230 V control pushbutton in addition to the rotary knob:**

Short commands switch on/off, continuous activation changes brightness up to maximum or minimum value. If you interrupt activation, it changes the dimming direction.

**Children's room circuit with control pushbutton:** Press the control pushbutton for a long time to switch on at minimum brightness, then continue pressing the pushbutton to dim up the lights slowly without changing the last dimming value stored.

**Sleep time with control pushbutton:** A double pulse dims down and switches off the lighting from the current dimming position through to minimum brightness.

The maximum dimming time of 60 minutes is dependent on the current dimming position and the adjusted minimum brightness and can therefore be shortened as required. Tap briefly at any time during dim-down process to switch off. Press long during the dimming-down process to dim up and end the sleep timer.

<b>DTD55L-230V-wg</b>	Rotary dimmer without N connection, pure white glossy	EAN 4010312317792	<b>56,40 €/pc.</b>
-----------------------	---	-------------------	--------------------



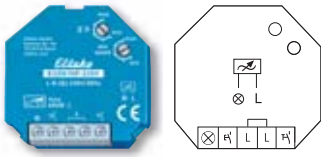

## EUD61NP-230V



**Without N connection, POWER MOSFET up to 400 W. Standby loss 0.5 watt only. With control inputs for pushbutton light switches and light switches. With adjustable minimum brightness and dimming speed.**

### Function rotary switches

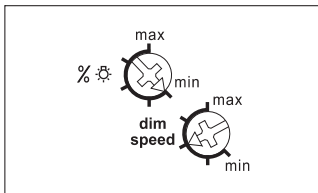

Standard setting ex works.

### Typical connection

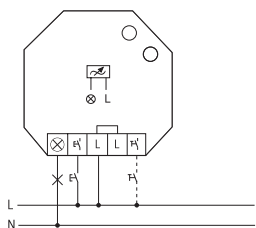

Control by pushbutton switches or light switches.

Built-in device for installation. 45 mm long, 45 mm wide, 18 mm deep.

Universal dimmer switch for R, L and C loads up to 400 watt, depending on ventilation conditions.

Automatic detection of load R+L or R+C.

Not compatible with energy saving lamps and 230 V LED, please use the EUD61NPL or the dimmer with N connection: EUD61NPN.

#### Zero passage switching with soft start and soft OFF to protect lamps.

Control voltage 230 V. Min. load 20 W.

Short-time control commands switch on/off, permanent control varies the brightness up to the maximum level. A short interruption of control changes the direction of dimming.

The brightness level is stored after switching off.

In case of a power failure the switching position and the brightness level are stored.

If applicable the dimmer will be switched on at the stored brightness level after the supply voltage is recovered.

Automatic electronic overload protection and over-temperature switch-off.

The minimum brightness level (completely dimmed down) can be adjusted **with the upper rotary switch** %⚙️.

The dimming speed can be adjusted **with the lower dimming speed rotary switch**. Simultaneously the soft on and soft off period is changed.

**If light switches cannot be replaced by pushbutton light switches, there is a separate control input for light switches.** If the switch is opened briefly after closing, the light is dimmed until the next time it is opened again briefly. The dimming direction changes automatically at both peaks. The dimming direction can also be changed by opening the switch briefly twice.

**Switching operation for children's rooms (only if controlled by pushbutton light switch):** If the light is switched on by holding down the pushbutton, it starts at the lowest brightness level after approx. 1 second and dims up slowly as long as the pushbutton is held down without modifying the last stored brightness level.

**Snooze function (only if controlled by pushbutton light switch):** With a double impulse the lighting is dimmed down from the current dimming position to the minimum brightness level and switched off. The current dimming position as well as the adjustable minimum brightness level determine the dimming time (max. = 60 minutes) which can be reduced as required. It can be switched off at any time by short-time control commands during the lighting is dimmed down. Holding down the pushbutton during the dimming down process dims up and stops the snooze function.

**Without N connection, therefore suitable for mounting directly behind the pushbutton light switch or light switch, even if no N wire is available.**

Mixing of L loads (inductive loads, e.g. wound transformers) and C loads (capacitive loads, e.g. electronic transformers) is not permitted. R loads (ohmic loads, e.g. 230 V incandescent lamps and halogen lamps) may be added anytime.

Technical data page 24.

<b>EUD61NP-230V</b>	Power MOSFET up to 400 W	EAN 4010312108062	<b>56,90 €/pc.</b>
---------------------	--------------------------	-------------------	--------------------

## UNIVERSAL DIMMER SWITCH EUD61NPL-230V WITHOUT N CONNECTION, ESPECIALLY FOR LED

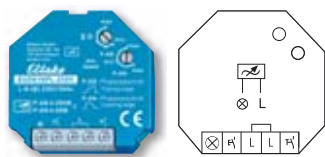

### EUD61NPL-230V



**Without N connection, POWER MOSFET up to 200 W. Standby loss 0.5 watt only. With control inputs for pushbutton light switches and light switches. With adjustable minimum brightness, dimming technology and dimming speed.**

#### Function rotary switches

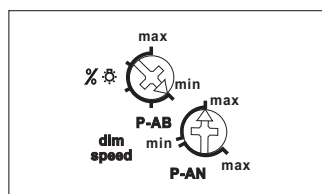

Standard setting ex works.

#### Typical connection

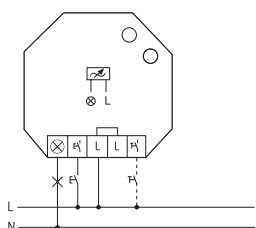

Control by pushbutton switches or light switches.

For installation. 45 mm long, 45 mm wide, 18 mm deep.

Universal dimmer switch for R and C loads up to 200 W, depending on ventilation conditions.

Dimmable energy saving lamps ESL and 230 V LED lamps in 'trailing edge' mode up to 200 W or up to 40 W in 'leading edge' mode, depending on ventilation conditions.

If 230 V LED lamps are lightly glowing when they are turned off, a GLE base load must be installed parallel to the lamp.

**It is not permitted to connect L loads (inductive loads, like wounded transformers).**

**Zero passage switching with soft start and soft OFF to protect lamps.**

Control voltage, supply voltage and switching voltage 230 V. Min. load 4 W.

Short-time control commands switch on/off, permanent control varies the brightness up to the maximum level. A short interruption of control changes the direction of dimming.

The brightness level is stored after switching off (memory). It is possible to deactivate the memory function by turning 3 times the upper rotary switch to the right stop (max), then it is compatible with ESL.

To reactivate the memory function (factory setting), turn the upper rotary switch 3 times to the left stop (min). In case of a power failure the switching position and the brightness level are stored, and will switch on after the failure if applicable.

Automatic electronic overload protection and over-temperature switch-off.

The minimum brightness level (completely dimmed down) can be adjusted **with the upper rotary switch** % ⚙️.

**The lower rotary switch** allows to choose between the both dimming technologies, P-AN leading or P-AB trailing edge and to change the dimming speed. Simultaneously the duration of soft on and soft off will be adjusted.

**If light switches cannot be replaced by pushbutton light switches, there is a separate control input**

**for light switches:** If the switch is opened briefly after closing, the light is dimmed until the next time it is opened again briefly. The dimming direction changes automatically at both peaks. The dimming direction can also be changed by opening the switch briefly twice.

**Switching operation for children's rooms (only if controlled by pushbutton light switch):** If the light is switched on by holding down the pushbutton, it starts at the lowest brightness level after approx. 1 second and dims up slowly as long as the pushbutton is held down without modifying the last stored brightness level.

**Snooze function (only if controlled by pushbutton light switch):** With a double impulse the lighting is dimmed down from the current dimming position to the minimum brightness level and switched off. The current dimming position as well as the adjustable minimum brightness level determine the dimming time (max. = 60 minutes) which can be reduced as required.

It can be switched off at any time by short-time control commands during the lighting is dimmed down. Holding down the pushbutton during the dimming down process dims up and stops the snooze function.

**Without N connection, therefore suitable for mounting directly behind the pushbutton light switch or light switch, even if no N wire is available.**

Technical data page 24.

<b>EUD61NPL-230V</b>	Power MOSFET up to 200 W	EAN 4010312109618	<b>56,50 €/pc.</b>
----------------------	--------------------------	-------------------	--------------------

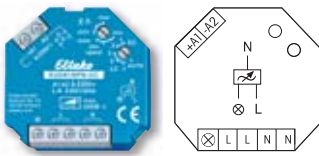

## EUD61NPN-UC



**Universal dimmer switch. Power MOSFET up to 400 W. Automatic lamp detection. Standby loss 0.1 watt only. With adjustable minimum brightness or dimming speed. With switching operation for children's rooms and snooze function.**

### Function rotary switches

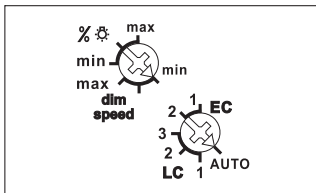

Standard setting ex works.

### Typical connection

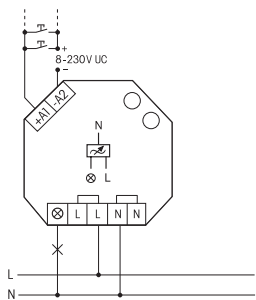

For installation. 45 mm long, 45 mm wide, 18 mm deep.

Universal dimmer switch for lamps up to 400 watts, depending on ventilation conditions. Dimmable energy saving lamps ESL and dimmable 230 V LED lamps dependent on the lamps electronics.

**Zero passage switching with soft start and soft OFF to protect lamps.**

**Universal control voltage input 8 to 230 V UC**, electrically isolated from the 230 V supply voltage and switching voltage. No minimum load required.

Short-time control commands switch on/off, permanent control varies the brightness to the maximum level. An interruption of control changes the direction of dimming.

The setting of the brightness level is stored after switching off (Memory).

In case of a power failure the switching position and the brightness level are stored. If applicable the dimmer will be switched on at the stored brightness level after the supply voltage is recovered.

Automatic electronic overload protection and over-temperature switch-off.

**With the top rotary switch %/dim speed** either the minimum brightness level (completely dimmed down) or the dim speed can be adjusted. The duration of soft-on and soft-off will be changed with the dimming speed.

In operation, the bottom rotary switch determines, whether automatic lamp detection or special comfort positions should operate:

**AUTO allows the dimming of all lamp types.**

**EC1** is a comfort position for energy saving lamps which must be switched on with increased power dependent on the construction, so they will also switch on again safely in cold condition when dimmed down.

**EC2** is a comfort position for energy saving lamps which will not be switched on again when dimmed down dependent on the construction. Memory is switched off in this position.

**LC1** is a comfort position for dimmable 230 V LED lamps which are not being dimmed down enough when set to AUTO (trailing phase angle) dependent on the construction and must therefore be forced to leading phase angle.

**LC2** and **LC3** are comfort positions for dimmable 230 V LED lamps like LC1, but with different dimming curves. **In positions EC1, EC2, LC1, LC2 and LC3 no inductive (wound) transformers should be used.** In addition, the maximum number of dimmable LED lamps can be lower than in the AUTO position dependent on the construction.

**With special switching operation for children's rooms:** If the light is switched on by holding down the pushbutton, it starts at the lowest brightness level after approx. 1 second and dims up slowly as long as the pushbutton is held down without modifying the last stored brightness level.

**Snooze function:** With a double impulse the lighting is dimmed down from the current dimming position to the minimum brightness level and switched off. The current dimming position as well as the adjustable minimum brightness level determine the dimming time (max. = 60 minutes) which can be reduced as required. It can be switched off at any time by short-time control commands during the lighting is dimmed down. Holding down the pushbutton during the dimming down process dims up and stops the snooze function.

Mixing of L loads (inductive loads, e.g. wound transformers) and C loads (capacitive loads, e.g. electronic transformers) is not permitted. R loads (ohmic loads, e.g. 230 V incandescent lamps and halogen lamps) may be added anytime.

Technical data page 24.

<b>EUD61NPN-UC</b>	Power MOSFET up to 400 W	EAN 4010312107874	<b>54,90 €/pc.</b>
--------------------	--------------------------	-------------------	--------------------

## UNIVERSAL DIMMER SWITCH EUD61NPN-230V

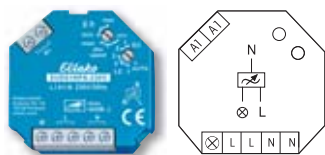

# EUD61NPN-230V



**Universal dimmer switch. Power MOSFET up to 400 W. Automatic lamp detection. Standby loss 0.1 watt only. With adjustable minimum brightness or dimming speed. With switching operation for children's rooms and snooze function.**

### Function rotary switches

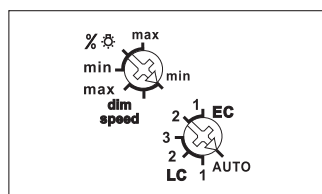

Standard setting ex works.

### Typical connection

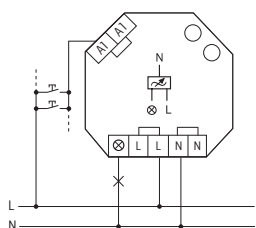

For installation. 45 mm long, 45 mm wide, 18 mm deep.

Universal dimmer switch for lamps up to 400 watts, depending on ventilation conditions. Dimmable energy saving lamps ESL and dimmable 230 V LED lamps dependent on the lamps electronics.

**Zero passage switching with soft start and soft OFF to protect lamps.**

**Control voltage**, supply voltage and switching voltage 230 V.

No minimum load required.

Short-time control commands switch on/off, permanent control varies the brightness to the maximum level. An interruption of control changes the direction of dimming.

The setting of the brightness level is stored after switching off (Memory).

In case of a power failure the switching position and the brightness level are stored. If applicable the dimmer will be switched on at the stored brightness level after the supply voltage is recovered.

Automatic electronic overload protection and over-temperature switch-off.

**With the top rotary switch % dim speed** either the dim speed can be adjusted or the minimum brightness level (completely dimmed down). The duration of soft-on and soft-off will be changed with the dimming speed.

In operation, **the bottom rotary switch** determines, whether automatic lamp detection or special comfort positions should operate:

**AUTO allows the dimming of all lamp types.**

**EC1** is a comfort position for energy saving lamps which must be switched on with increased power dependent on the construction, so they will also switch on again safely in cold condition when dimmed down.

**EC2** is a comfort position for energy saving lamps which will not be switched on again when dimmed down dependent on the construction. Memory is switched off in this position.

**LC1** is a comfort position for dimmable 230 V LED lamps which are not being dimmed down enough when set to AUTO (trailing phase angle) dependent on the construction and must therefore be forced to leading phase angle.

**LC2** and **LC3** are comfort positions for dimmable 230 V LED lamps like LC1, but with different dimming curves. **In positions EC1, EC2, LC1, LC2 and LC3 no inductive (wound) transformers should be used.** In addition, the maximum number of dimmable LED lamps can be lower than in the AUTO position dependent on the construction.

**With special switching operation for children's rooms:** If the light is switched on by holding down the pushbutton, it starts at the lowest brightness level after approx. 1 second and dims up slowly as long as the pushbutton is held down without modifying the last stored brightness level.

**Snooze function:** With a double impulse the lighting is dimmed down from the current dimming position to the minimum brightness level and switched off. The current dimming position as well as the adjustable minimum brightness level determine the dimming time (max. = 60 minutes) which can be reduced as required. It can be switched off at any time by short-time control commands during the lighting is dimmed down. Holding down the pushbutton during the dimming down process dims up and stops the snooze function.

Mixing of L loads (inductive loads, e.g. wound transformers) and C loads (capacitive loads, e.g. electronic transformers) is not permitted. R loads (ohmic loads, e.g. 230 V incandescent lamps and halogen lamps) may be added anytime.

Technical data page 24.

<b>EUD61NPN-230V</b>	Power MOSFET up to 400 W	EAN 4010312109564	<b>54,90 €/pc.</b>
----------------------	--------------------------	-------------------	--------------------

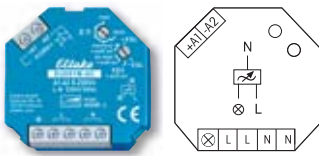

## EUD61M-UC



**Universal dimmer switch. Power MOSFET up to 400 W. Automatic lamp detection. Standby loss 0.1 watt only. With adjustable minimum brightness. With switching operation for children's rooms and snooze function.**

### Function rotary switches

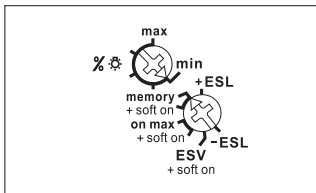

Standard setting ex works.

### Typical connection

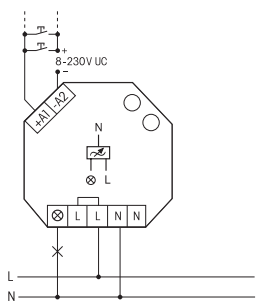

Built-in device for installation. 45 mm long, 45 mm wide, 18 mm deep.

Universal dimmer switch for lamps up to 400 W, depending on ventilation conditions, dimmable energy saving lamps (ESL) and dimmable 230 V LED lamps are also dependent on the lamp electronics.

**Zero passage switching with soft start and soft OFF to protect lamps.**

**Universal control voltage input 8 to 230 V UC**, electrically isolated from the 230 V supply voltage and switching voltage.

Short-time control commands switch on/off, permanent control varies the brightness to the maximum level.

A interruption of control changes the direction of dimming. The brightness level is stored after switching off in case the **function memory** is set. If the **function on max** is set, it always switches on at the maximum brightness level.

In case of a power failure the switching position and the brightness level are stored.

If applicable the dimmer will be switched on at the stored brightness level after the supply voltage is recovered.

Automatic electronic overload protection and over-temperature switch-off.

The minimum brightness level (completely dimmed down) can be adjusted with **the upper rotary switch** %⚙️, e.g. for dimmable energy saving lamps.

**You can dim all lamp types in automatic mode.**

**Use the lower function rotary switch** to select between five automatic mode functions: memory, memory+soft on, on max, on max+soft on and ESV+soft on.

**+ESL** is a convenience setting for energy saving lamps which must be switched on at high voltage for design reasons so that they can also be switched back on cold in dimmed state.

**-ESL** is a convenience setting for energy saving lamps which cannot be switched back on in dimmed state for design reasons. This is why memory is switched off in this position.

No inductive (wound) transformers may be used in +ESL and -ESL settings. In addition the maximum number of dimmable energy saving lamps may be lower than in automatic mode for design reasons.

**Setting of function ESV** same as 'memory+soft on' with setting of a release delay up to 90 minutes with the rotary switch %⚙️ if the manual off command is not given. Before time-out switch-off early warning function by dimming down within 1 minute.

**Switching operation for children's rooms:** If the light is switched on by holding down the pushbutton, it starts at the lowest brightness level after approx. 1 second and dims up slowly as long as the pushbutton is held down without modifying the last stored brightness level.

Snooze function: With a double impulse the lighting is dimmed down from the current dimming position to the minimum brightness level and switched off. The current dimming position as well as the adjustable minimum brightness level determine the dimming time (max. = 60 minutes) which can be reduced as required. It can be switched off at any time by short-time control commands during the lighting is dimmed down. Holding down the pushbutton during the dimming down process dims up and stops the snooze function.

Mixing of L loads (inductive loads, e.g. wound transformers) and C loads (capacitive loads, e.g. electronic transformers) is not permitted. R loads (ohmic loads, e.g. 230 V incandescent lamps and halogen lamps) may be added anytime.

Technical data page 24.

<b>EUD61M-UC</b>	Power MOSFET up to 400 W	EAN 4010312107973	<b>54,90 €/pc.</b>
------------------	--------------------------	-------------------	--------------------

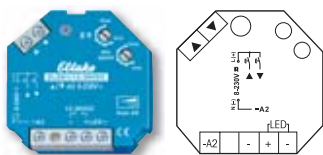

# ELD61/12-36V DC



**Power MOSFET for LED lamps 12-36 V DC up to 4 A, pulse width modulation PWM. Stand-by loss 0.1 Watt only. With adjustable minimum brightness and dimming speed. With switching operation for children's rooms and snooze function.**

### Function rotary switches

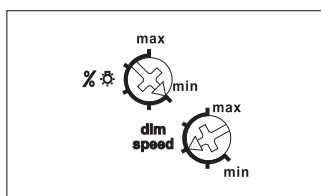

Standard setting ex works.

### Typical connection

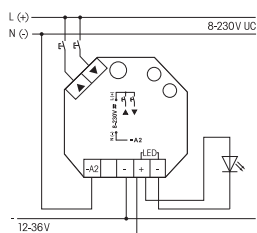

Technical data page 24.

For installation. 45 mm long, 45 mm wide, 18 mm deep.

Dimmer switch for R- and LED loads up to 4 A depending on ventilation conditions.

**Zero passage switching with soft start and soft OFF to protect lamps.**

Supply voltage input 12 to 36 V DC, depending on the connected LED illumination.

A pulse resistant switching power supply unit is necessary.

**Universal control voltage 8..230 V UC**, electrically isolated from the supply voltage.

Either direction pushbuttons can be connected to ▲ ▼ or these terminals will be bridged and a pushbutton will be connected as an universal pushbutton.

With universal pushbutton: short commands switch on/off, permanent control changes the brightness to the maximum. An interruption of the control changes the dimming direction.

With direction pushbutton: switching and dimming on with ▲, turning and dimming off with ▼. A dual pulse with ▲ effects dimming on up to the maximum brightness with the set dimming speed (dimspeed). The set brightness level will be stored when turning off (Memory).

In case of power failure the switching position and the brightness level will be stored and will be switched on when supply voltage recurs.

Automatic electronic overload protection and overtemperature switch off.

The LED indicates an activation by a short flickering.

**With the top rotary switch** % ⚙️ the minimum brightness level (completely dimmed down) can be adjusted.

**With the lower dim speed rotary switch**, the dimming speed can be set. At the same time, soft-on and soft-off is changed.

**With switching operation for children's rooms (universal or direction pushbutton ▲):**

if the light is switched on by holding down the pushbutton it starts at the lowest brightness level after approx. 1 second and dims up slowly as long as the pushbutton is pressed without modifying the latest stored brightness level.

**Snooze function (universal or direction pushbutton ▼):** with a double impulse the lighting is dimmed down from the current dimming position to the minimum brightness level and switched off. The current dimming position as well as the adjustable minimum brightness level determine the dimming time (max. = 60 minutes) which can be reduced as required. It can be switched off at any time by short-time control commands during the lighting is dimmed down. Holding down the pushbutton during the dimming down process dims up and stops the snooze function.

<b>ELD61/12-36V DC</b>	Power MOSFET up to 4 A	EAN 4010312109502	<b>52,70 €/pc.</b>
------------------------	------------------------	-------------------	--------------------

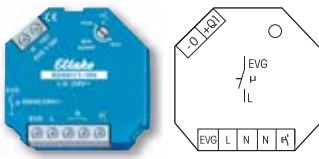

## SDS61/1-10V



**1 NO contact not potential free 600 VA and 1-10 V control output 40 mA. Only 1 watt standby loss. With adjustable dimming speed. With switching operation for children's rooms and snooze function. With pushbutton or switch activation.**

### Function rotary switch

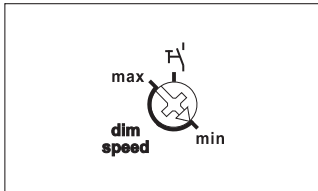

Standard setting ex works.

### Typical connection

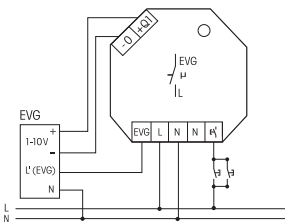

Technical data page 24.

Built-in device for installation. 45 mm long, 45 mm wide, 33 mm deep.

**Zero passage switching with soft ON and soft OFF to protect lamps.**

**Also adapted for LED driver with 1-10 V passive interface, without voltage source up to 0.6 mA, above this value an additional voltage source is necessary.**

Switching voltage and control voltage 230 V.

State-of-the-art hybrid technology combines advantages of nonwearing electronic control with high capacity of special relays.

The load is switched on and off by a bistable relay at output EVG (electronic ballast units). Switching capacity for fluorescent lamps or LV halogen lamps with electronic ballast units 600 VA.

**By using a bistable relay coil power loss and heating is avoided even in the on mode.**

After installation, wait for short automatic synchronisation before the switched consumer is connected to the mains.

Short-time control commands switch on/off, permanent control varies the brightness up to the maximum level. An interruption of control changes the direction of dimming.

The brightness level is stored after switching off.

In case of a power failure the switching position and the brightness level are stored.

If applicable the dimmer will be switched on at the stored brightness level after the supply voltage is recovered.

The dimming speed is adjustable **using the dimming speed rotary switch (only for pushbutton activation).**

**If light switches cannot be replaced by light pushbuttons, the rotary switch can be set to the switch symbol at the right stop:**

When the closed switch is briefly opened, the light is dimmed until the switch is briefly opened again. The dimming direction is changed automatically at each of the two vertices. In addition the direction can be changed by opening the switch briefly twice.

**Switching operation for children's rooms (only for pushbutton activation):** If the light is switched on by holding down the pushbutton, it starts at the lowest brightness level after approx. 1 second and dims up slowly as long as the pushbutton is held down without modifying the last stored brightness level.

**Snooze function (only for pushbutton activation):** With a double impulse the lighting is dimmed down from the current dimming position to the minimum brightness level and switched off. The current dimming position as well as the adjustable minimum brightness level determine the dimming time (max. = 60 minutes) which can be reduced as required. It can be switched off at any time by short-time control commands during the lighting is dimmed down. Holding down the pushbutton during the dimming down process dims up and stops the snooze function.

SDS61/1-10V	1 NO contact 600 VA	EAN 4010312109496	52,30 €/pc.
-------------	---------------------	-------------------	-------------

## TECHNICAL DATA UNIVERSAL DIMMER SWITCHES, CAPACITY ENHANCERS AND 1-10 V CONTROLLERS

Type	ELD61 <sup>1)</sup>	EUD12NPN <sup>1)</sup> EUD12D <sup>1)</sup> EUD12DK <sup>1)</sup> LUD12 <sup>1)</sup> MFZ12PMD <sup>1)</sup>	EUD61NPN <sup>1)</sup> EUD61M <sup>1)</sup> EUD61NP <sup>1)</sup> EUD61NPL <sup>1)</sup>	EUD12F <sup>1)</sup>	SDS12 SUD12	SDS61	MOD12D	DTD65 <sup>1)</sup> DTD65L <sup>1)</sup> DTD55 <sup>1)</sup> DTD55L <sup>1)</sup>
Spacing of control connections/load	6 mm	6 mm	6 mm EUD61NP: 3 mm	6 mm	6 mm	3 mm	6 mm	3 mm
Incandescent and halogen lamps 230 V (R)	-	up to 400 W EUD12DK: up to 800 W	up to 400 W EUD61NPL: 200 W	up to 300 W	-	-	-	up to 300 W DTD65L and DTD55L: up to 200 W
Inductive transformers (L) <sup>2)3)</sup>	-	up to 400 W EUD12DK: up to 800 W	up to 400 W (not EUD61NPL)	up to 300 W	-	-	-	up to 300 W DTD65L and DTD55L: -
Motor (L)	-	-	-	-	-	-	up to 300 W <sup>7)</sup>	-
Capacitive transformers (C) <sup>3)8)</sup>	-	up to 400 W EUD12DK: up to 800 W	up to 400 W EUD61NPL: 200 W	up to 300 W	-	-	-	up to 300 W DTD65L and DTD55L: up to 200 W
Dimmable energy saving lamps ESL <sup>5)6)9)</sup>	-	up to 400 W EUD12DK: up to 800 W	up to 400 W EUD61NPL: 200 W (not EUD61NP)	up to 300 W	-	-	-	up to 300 W DTD65L/FL and DTD55L: up to 200 W
Dimmable 230 V LED lamps <sup>5)6)9)</sup>	-	up to 400 W EUD12DK: up to 800 W	up to 400 W EUD61NPL: 200 W (not EUD61NP)	-	-	-	-	up to 300 W DTD65L and DTD55L: up to 200 W
Dimmable LED lamps 12-36 V DC	4 A	-	-	-	-	-	-	-
1-10 V EVG*	-	-	-	-	40 mA 600 VA	40 mA 600 VA	-	-
Maximum conductor cross-section (3-fold terminal)	4 mm <sup>2</sup>	6 mm <sup>2</sup> (4 mm <sup>2</sup> )	4 mm <sup>2</sup>	6 mm <sup>2</sup> (4 mm <sup>2</sup> )	6 mm <sup>2</sup> (4 mm <sup>2</sup> )	4 mm <sup>2</sup>	6 mm <sup>2</sup> (4 mm <sup>2</sup> )	4 mm <sup>2</sup>
Two conductors of same crosssection (3-fold terminal)	1.5 mm <sup>2</sup>	2.5 mm <sup>2</sup> (1.5 mm <sup>2</sup> )	1.5 mm <sup>2</sup>	2.5 mm <sup>2</sup> (1.5 mm <sup>2</sup> )	2.5 mm <sup>2</sup> (1.5 mm <sup>2</sup> )	1.5 mm <sup>2</sup>	2.5 mm <sup>2</sup> (1.5 mm <sup>2</sup> )	1.5 mm <sup>2</sup>
Screw head	slotted/crosshead	slotted/crosshead, pozidriv	slotted/crosshead	slotted/cross- head, pozidriv	slotted/cross- head, pozidriv	slotted/cross- head	slotted/cross- head, pozidriv	slotted/cross- head, pozidriv
Type of enclosure/terminals	IP30/IP20	IP50/IP20	IP30/IP20	IP50/IP20	IP50/IP20	IP30/IP20	IP50/IP20	IP50/IP20
Time on	100%	100%	100%	100%	100%	100%	100%	100%
Max./min. temperature at mounting location <sup>4)</sup>	+50°C/-20°C	+50°C/-20°C	+50°C/-20°C	+50°C/-20°C	+50°C/-20°C	+50°C/-20°C	+50°C/-20°C	+50°C/-20°C
Standby loss (active power)	0.1 W	0.1 W EUD12DK: 0.2 W EUD12D and MFZ12PMD: 0.3 W	0.1 W EUD61NP: 0.5 W	0.1 W	1 W SUD12: 0.9 W	1 W	0.3 W	0.14 W DTD65L and DTD55L: 0.5 W
Control voltage	8..230 V UC	8..230 V UC	8..230 V UC EUD61NPN-230V und EUD61NP: 230V	internal DC voltage	8..230 V UC	230 V	8..230 V UC	230 V
Control current 230 V-control input (<5 s)	-	-	EUD61NP: 0.7 mA EUD61NPN-230V: 4(100) mA	-	-	0.5 mA	-	0.4 mA
Control current universal control voltage all control voltages (<5 s)	-	10(100) mA	-	-	-	-	2/3/8/5 (100) mA	-
8/12/24/230 V (<5 s)	2/3/7/4(100) mA	-	2/3/7/4(100) mA	-	-	3/5/10/4(100) mA	-	-
Control current central 8/12/24/230 V (<5 s)	-	3/5/10/4(100) mA	-	-	-	3/5/10/4(100) mA	-	2/3/8/5 (100) mA
Max. parallel capacitance (approx. length) of single control lead at 230 V AC	0.3 µF (1000 m)	0.9 µF (3000 m)	0.9 µF (3000 m) EUD61NP: 0.3 µF (1000 m)	-	0.3 µF (1000 m)	0.06 µF (200 m)	0.9 µF (3000 m)	0.3 µF (1000 m)
Max. parallel capacitance (approx. length) of central control lead at 230 V AC	-	0.9 µF (3000 m)	-	-	0.3 µF (1000 m)	-	0.9 µF (3000 m)	-

\* EVG = electronic ballast units; KVG = conventional ballast units<sup>1)</sup> Secondary cable length with a maximum of 2 m. <sup>1)</sup> At a load of more than 200 W (EUD12DK: 400 W, EUD12F: 100 W) a ventilation clearance of 1/2 module to adjacent devices must be maintained. The switching capacity of the EUD61 and DTD depends also on the ventilation conditions. <sup>2)</sup> Per dimmer or capacity enhancer it is only allowed to use max. 2 inductive (wound) transformers of the same type, **furthermore no-load operation on the secondary part is not permitted. The dimmer might be destroyed.** Therefore do not permit load breaking on the secondary part. Operation in parallel of inductive (wound) and capacitive (electronic) transformers is not permitted! <sup>3)</sup> When calculating the load a loss of 20% for inductive (wound) transformers and a loss of 5% for capacitive (electronic) transformers must be considered in addition to the lamp load. <sup>4)</sup> Affects the max. switching capacity. <sup>5)</sup> In the settings ESL and LED no wound (inductive) transformer must be dimmed. <sup>6)</sup> Increase of capacity for dimmable energy saving lamps ESL and dimmable 230 V LED lamps see page 9-8. <sup>7)</sup> Only 1 fan motor may be connected. <sup>8)</sup> For 12 V halogen and LED lamps. <sup>9)</sup> Usually applies for dimmable energy saving lamps and dimmable 230 V LED lamps. Different lamp electronics may result in restricted dimming areas, on/off problems and a limited maximum number of lamps (to 10 units), especially if the connected load is very low (e.g. with 5 W LEDs). The comfort positions of the dimmer switches optimize the dimming range, which, however, only gives a maximum power up to 100 W. No inductive (wound) transformers may be dimmed in these comfort positions.

To comply with DIN VDE 0100-443 and DIN VDE 0100-534, a Type 2 or Type 3 surge protection device (SPD) must be installed.





**DO YOU HAVE ANY QUESTIONS?  
WE HAVE THE ANSWERS FOR YOU.**



**Technical support:**  
+49 711 943 500 25  
technical-support@eltako.de

**Commercial support:**  
+49 711 943 500 00  
export@eltako.de

eltako.com