



## The Modular Approach

The modular approach for the electrical trade	H0
Sensors for brightness, wind, rain, and frost	H1
Multifunction sensor relay <a href="#">MSR12</a>	H2
Digital settable sensor relay <a href="#">LRW12D</a>	H3
Actuator impulse group switch <a href="#">EGS12Z</a>	H4
Actuator impulse group switch <a href="#">EGS12Z2</a>	H5
Motor isolating relay <a href="#">MTR12</a> and DC motor relay <a href="#">DCM12</a>	H5
Actuators impulse group switch <a href="#">EGS61Z</a> and motor isolating relay <a href="#">MTR61</a>	H6
Installation guidelines and technical data	H7
Typical circuit example	H8

## The modular approach for the electrical trade

Planning and realisation of a shading system or roller shutter control are classical tasks for the electrical installer. ELTAKO has developed a well thought-out modular system of control devices and switchgear for mounting in switch cabinets and distribution boards.

The modular approach has been chosen to provide a control or switchgear device (module) for any desired function match the overall system, typically permitting an individual awning to be controlled as perfectly as a large system which comprises dozens of shutters, awnings, Venetian blinds, etc.

Any assignment of control devices to the switchgear devices can be chosen, and provision is made for easy modifications, retrofitting and expansion, "bit by bit".

There are four groups of devices

### 1. Sensors

Sensors serve to detect the actual situation. A light sensor, for example, measures brightness and generates a control voltage as a function of it. Momentary contact switches are switches employed to transmit the SHUT or OPEN condition in terms of a voltage.

### 2. Sensor relays

Sensor relays serve to convert the sensor-produced actual signals to control signals as a function of practical set points, whilst logic operations are performed and faulty sensors detected. Signals from switches and momentary contact switches do not require series-connected sensor relays as they act directly on actuators.

### 3. Actuators

Actuators serve to control the motors of shading systems and roller shutters. These are group impulse switches in hybrid technology with central control functions and possibly motor isolating relays or DC motor relays.

### 4. Accessories

Switching power supply units for the power supply of the multi sensor and the multifunction sensor relay as well as for the heating of the rain sensors are available as accessories.

Page	Sensor relays H2+H3	Actuators H4-H6
		
Multi sensor <b>MS</b>	Multifunction sensor relay <b>MSR12</b> for brightness, twilight, wind, rain and frost	Group impulse switch <b>EGS12Z</b>
Rain sensor <b>RS</b>	Light-twilight-rain-wind sensor relay <b>LRW12D</b> for light, twilight and wind	Group impulse switch <b>EGS12Z2</b>
Light sensor <b>LS</b>		Group impulse switch <b>EGS61Z</b>
Wind sensor <b>WS</b>		Motor isolating relay <b>MTR12</b> and <b>MTR61</b>
Switches <b>A12</b> , momentary contact switches <b>T12</b> and <b>ZT12</b>		DC motor relay <b>DCM12</b>

**The principle of overall control is quite simple: each shading element or its motor is controlled by an actuator that receives commands via sensors and, where fitted, sensor relays.**

**A complete Control System consists (as the smallest unit) of a switch or momentary contact switch controlled EGS12Z group impulse switch for one motor. The largest unit comprises any number of sensors and sensor relays as well as any number of impulse group switches EGS12Z and EGS12Z2 with or without motor isolating relay MTR12 and DC motor relay DCM12 to control the motors.**

## Multi sensor MS



The MS multi sensor sends the current weather details, including brightness (from three points of the compass), wind, rain and frost, to the multifunction sensor relay MSR12 connected in series once per second. A standard telephone wire is sufficient as connecting lead: J-Y(ST)Y 2x2x 0,8 or equivalent. 100m line length is permitted. Solid plastic housing, l x w x h = 118x96x77mm. Degree of protection IP44. Temperature at mounting location -30°C to +50°C. A power supply unit SNT12-230V/24V DC (product group I) is required for the power supply, including heating of the rain sensor. This is only 1 module = 18mm wide and it also it supplies the multifunction sensor relay MSR12 (page H2). Several MSR12 can be connected to a multisensor MS, e.g. for evaluating up to three directions with the light sensor of the MS.

**Multi sensor MS**

EAN 4010312901731

**267,30 €/pc.**

## Rain sensor RS



The rain sensor RS reports rain to the sensor relay LRW12D connected in series once per second. A standard telephone wire is sufficient as connecting lead: J-Y(ST)Y 2x2x 0,8 or equivalent. 100m line length is permitted. Solid plastic housing, l x w x h = 118x96x77mm. Degree of protection IP44. Temperature at mounting location -30°C to +50°C. A power supply unit SNT61-230V/24V DC or SNT12-230V/24V DC (page I0) is required for the power supply, including heating of the rain sensor (1.2W). An LED lights up green when the supply voltage is applied and lights up yellow for rain.

**Regensensor RS**

EAN 4010312206546

**113,20 €/pc.**

## Light sensor LS



The LS light sensor generates a voltage dependent on light intensity by means of a photo resistor. This voltage is evaluated in a LRW12D universal sensor relay connected in series. Solid plastic housing, l x w x h = 37x25x68mm. IP 54 enclosure protection. Temperature at mounting location -15°C to +60°C. For mounting, use aluminium bracket, or the fastening screw that also comes with the device, directly on the KM1 plastic mounting bracket of the wind sensor. Without measuring lead.

**Light sensor LS**

EAN 4010312901267

**42,70 €/pc.**

## Wind sensor WS



The WS wind sensor provides a sequence of pulses as a function of the wind vane speed. This pulse sequence is evaluated in a LRW12D universal sensor relay connected in series. Solid plastic housing, 125mm dia. x117mm high. IP 54 enclosure protection. Temperature at mounting location -15°C to +60°C. For mounting, use KM1 plastic mounting bracket that comes with the device. With 5-metre measuring lead connected. The KM1 plastic mounting bracket is also available as an individual (accessory) item (see page Z4).

**Wind sensor WS**

EAN 4010312901281

**53,20 €/pc.**

## On/Off switch A12, momentary-contact switch T12 and ZT12



External control of actuators takes place by means of commercially available switches, momentary-contact switches, thermostats and, for particular applications, clock timers. Eltako switches and momentary-contact switches that are one module = 18mm wide and 55mm deep, are available for control in distribution boards and control panels as applicable, in particular the ZT12 dual momentary-contact switch for UP and DOWN central control.

**On/Off switch**

1 NO A12-100-16A

EAN 4010312700815

**13,10 €/pc.**

**Momentary-contact switch**

1 NO contact T12-100-16A-blue

EAN 4010312700846

**13,90 €/pc.**

**Dual momentary-contact switch**

1+1 NO contacts ZT12-200-16A-blue

EAN 4010312700877

**24,80 €/pc.**

Recommended retail prices excluding VAT.

# Multifunction Sensor Relay MSR12

**MSR12-8..230V UC**

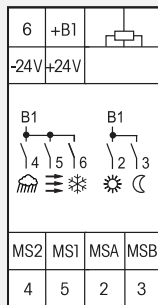

**Multifunction sensor relay for brightness, twilight, wind, rain and frost, 5 OptoMOS semiconductor outputs 50 mA/8..230V UC. Standby loss without Multi sensor MS 0.5 watt only.**

Modular device for DIN 60715 TH35 rail mounting.  
2 modules = 36mm wide, 58mm deep.

The multi-sensor relay MSR12 evaluates the signals from the multisensor MS once per second, and sends appropriate control signals to the downstream EGS12Z or EGS12Z2 actuators depending on the setting of the rotary switch on the front.

The OptoMOS semiconductor outputs switch the voltage applied to the universal voltage input terminal +B1. Only a single Multisensor MS can be connected to a Multifunction sensor relay MSR12. Several MSR12 can be connected to a multisensor MS, e.g. for evaluating up to three directions with the light sensor of the MS. Only a single MSR12 must provide the outer terminal resistance. It must be removed if there is a further MSR12. Supply voltage 24 V DC from power unit SNT12-230V/24V DC (product group I). This power unit simultaneously supplies the multisensor MS connected to the terminals MS1, MS2, MSA and MSB, including heating of the rain sensor surface. After installation wait for the short automatic synchronisation of approx. 1 minute. During this process three LEDs flash in a slow sequence.

## Function rotary switches

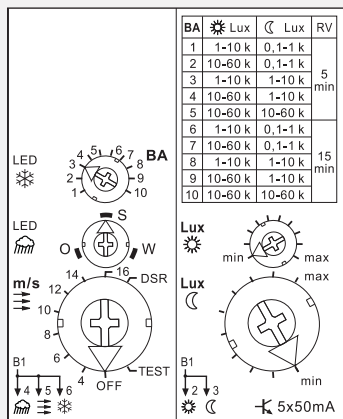

Standard setting ex factory.

## Function rotary switches

**BA** = Setting the operating modes 1 to 10 from the adjacent table. 2 delay times RV - for wind and twilight - each in connection with 5 brightness ranges for light and twilight. The LED behind the rotary switch indicates Frost when the outdoor temperature drops below 2°C, at which point output 6 closes. This output opens again as soon as the temperature is over 3°C for 5 minutes.

**O-S-W** = If the Multisensor MS is aligned towards the south, the weighting for light and twilight can be shifted towards the east or west. If the MS is mounted in a different direction, the desired point of the compass can be set using this rotary switch. An LED behind the rotary switch indicates **rain detection**, at which point output 4 closes. Once the rain sensor surface dries out - assisted by a heating unit - contact 4 opens immediately. This is automatically followed by a 2-second pulse on output 2 if the sun signal is applied at that moment.

**m/s** = This rotary switch is used to select the wind speed in metres per second at which the **wind signal** is triggered. This closes output 5. This is indicated by the LED behind the rotary switch. Opening takes place after the set delay time RV, during which the LED flashes. This is automatically followed by a 2-second pulse on output 2 if the sun signal is applied at that moment.

**DSR** = In this position of the wind rotary switch the MSR12 functions like a twilight sensor relay. The twilight signal as described under **Lux ☾** is then continuously applied to output 3 as long as the set twilight value is undershot. Output 3 opens with a delay of 5 minutes if the brightness value set is overshot. The outputs 4 (rain) and 6 (frost) remain active as described there. Output 5 (wind) likewise remain active, but the wind signal is triggered at 10 m/s.

**TEST** = As long as TEST remains switched on, each switchover from the OFF position to the TEST position activates the outputs 2 to 6 in ascending order.

**OFF** = In the OFF position the MSR12 has no function.

**Lux ☾** = This rotary switch is used to set the brightness at which the sun signal is immediately triggered as a 2-second pulse at output 2. The LED behind the rotary switch indicates when the brightness value is exceeded.

**Lux ☀** = This rotary switch is used to set the brightness at which the 2-second twilight signal is triggered at output 3 after the set delay time RV when the value is undershot. This is indicated by the LED behind the rotary switch. It flashes during the delay time. If the twilight switching threshold is set to the same level or higher than the sun switching threshold, then the sun switching threshold is raised internally above the twilight switching threshold.

**Changing light compensation:** Constant changes between sun and rain clouds would result in sensitive closing and opening of the shade elements. This is prevented by a changing light compensation function.

**Sensor function and open circuit monitoring:** The Multisensor MS sends updated information to the MSR12 every second. If this signal is missing completely for 5 seconds, or if the individual signal from the wind sensor is missing for 24 hours, then an alarm is triggered: three LEDs flash rapidly and the wind output 5 is closed for 2 seconds in order to protect any awnings or windows which may be connected here. This pulse is repeated every hour. The alarm is turned off automatically when a signal is detected again.

Technical data page H7.

Connection example page H8.

Housing for operating instructions GBA12 page Z5.

**MSR12-8..230V UC**

5 OptoMOS

EAN 4010312205327

**87,40 €/pc.**

Recommended retail prices excluding VAT.

## LRW12D-UC

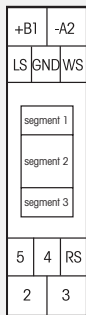

### Light-twilight rain wind sensor relay, 4 OptoMOS semiconductor outputs 50 mA/8..230V UC. Standby loss 0.05–0.5 watt only.

Modular device for DIN 60715 TH35 rail mounting. 1 module = 18 mm wide, 58 mm deep. Supply voltage 8 to 230V UC.

The sensor relay LRW12D evaluates the signals from the light sensor LS, the rain sensor RS and the wind sensor WS and sends appropriate control signals to the downstream EGS12Z or EGS12Z2 actuators depending on the setting via the display on the front panel.

The OptoMOS semiconductor outputs switch the voltage applied to the universal voltage input terminal +B1.

A light sensor LS, rain sensor RS and wind sensor WS can be connected to a sensor relay LRW12D. However, only one per sensor.

However, at a wind sensor WS several LRW12D can be connected for controlling different wind speeds. Then the LRW12D must be connected to the same potential +B1/-A2.

When the supply voltage UC (8-253V AC or 10-230V DC) is applied to B1/A2, the LRW12D can be set:

First **segment 1** indicates 'LS' or 'DSR' and **segment 3** may then indicate closed outputs 2, 3, 4 or 5. 'LS' indicates that the LRW12D is set as light sensor relay (factory setting) and 'DSR' shows that it is set as light-twilight relay. In both settings, the signals of connected rain and wind sensors may also be evaluated. A light sensor need not be connected.

**Segment 2** indicates alternating events: s = brightness overshoot (sun), m = brightness undershoot (moon). If a release delay runs, the affected output flashes in segment 3.

Select the function for which values require changes by pressing the countersunk buttons **MODE** and **SET**:

**LS = light sensor, WS = wind sensor, RS = rain sensor, DSR = light-twilight relay, TST = test** and **OFF = switch all functions on/off**.

#### Subfunctions at LS = light sensor

Display current light sensor measuring value LSM in klux. At LSS set the brightness from 3 to 60klux; this setting immediately triggers the sun signal as a 2 second impulse at output 2 in the event of an overshoot. At LSD set the brightness from 1 to 40klux; this setting triggers the light-twilight signal as a 2-second impulse at output 3 in the event of an undershoot dependent on the set delay time.

#### Subfunctions at WS = wind sensor

Display current wind sensor measuring value WSM in m/s. At WSS set the wind speed from 2 to 20m/s; this setting immediately triggers the wind signal by closing output 5 in the event of an overshoot. If the wind speed again drops below the set value, the output is released after the set delay time. If the sun signal is applied at this moment, a 2-second impulse is triggered at output 2.

#### Subfunctions at RS = rain sensor

When it rains, output 4 is closed. After the sensor surface is dried with the help of the heater, output 4 opens on expiry of the set delay time. If the sun signal is applied at this moment, a 2-second impulse is triggered at output 2.

#### Subfunctions at DSR = light/twilight sensor relay

At DSD set the brightness from 20 to 800 lux; this immediately closes output 3 in the event of an undershoot.

Hysteresis then increments automatically by 2 steps higher.

At DSS set the brightness from 160 to 2000 lux; this opens output 3 in the event of an overshoot on expiry of the set delay time.

Hysteresis then decrements automatically by 2 steps lower.

The **'TST' function** closes the OptoMOS outputs 2, 3, 4 and 5 in succession for testing and the **'OFF' function** switches the LRW12D on or off. After the setting operation the required values can be interlocked.

#### Changing light compensation

Constant changes between sun and rain clouds would result in sensitive closing and opening of the shade elements.

This is prevented by a changing light compensation function.

#### Sensor function and open circuit monitoring

If the signal from the light sensor or the wind sensor is missing for 24 hours, then an alarm is triggered: The display indicates 'FLS' or 'FWS'. Failure of the wind sensor results in a 2-seconds pulse at output 5 in order to protect any awnings or windows which may be connected here. This pulse is repeated every hour. Rain sensor failure or a line break causes output 4 to close. The display indicates 'FRS' 36 hours later. If several faults occur simultaneously, they are each displayed for one second in succession.

When signals are detected again, each alarm stops automatically.

Technical data page H7. Connection example page H9. Housing for operating instructions GBA12 page Z5.

LRW12D-UC

4 OptoMOS

EAN 4010312206553

65,30 €/pc.

Recommended retail prices excluding VAT.

H3

## EGS12Z-8..230V UC

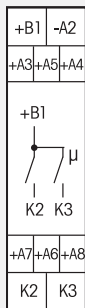

### Impulse group switch for central control, 1 + 1 NO contacts not potential free 16A/250V AC, for 1 motor or motor relays. Standby loss 0.05–0.4 watt only.

Modular device for DIN 60715 TH35 rail mounting.  
1 module = 18 mm wide, 58 mm deep.

This impulse group switch serves to implement commands generated by the sensor relays or by switches and push-buttons and controls a motor, a motor isolating relay MTR12-8..230V UC or a DC motor relay DCM12-8..230V UC dependent on the setting of the rotary switch on the front.

8 to 230V UC supply voltage and switching voltage at terminals +B1/-A2. The control voltage at terminals A3 up to A8 must have an identical potential.

The **function** of this electronic group impulse switch is based on the principle that, on the one hand, impulse control is used to obtain UP-Stop-DOWN-Stop (contact 1 closed - both contacts open - contact 2 closed - both contacts open) and, on the other hand, additional control inputs can be used to select UP or DOWN as desired. **Dynamic** refers to control inputs for which one impulse of not less than 20 milliseconds is sufficient to close a contact. **Static** denotes a control input for which the contact is only closed as long as the control command is applied. UP and DOWN apply to roller shutters, Venetian blinds and roller blinds. For awnings, 'UP' = retract and 'DOWN' = extend. For windows 'UP' = open and 'DOWN' = close.

#### Function rotary switches

#### Function rotary switches

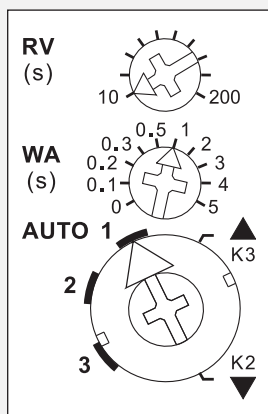

Standard setting ex factory.

**AUTO 1** = When the lower rotary switch is in this position, the local advanced automatic reversing system for Venetian blinds is activated. When a push-button connected to A3 + A4 (connected with a bridge) or A5/A6 connected to a dual push-button are used for local control a double impulse activates a slow rotation in the opposite direction, which can be stopped with a further impulse.

**AUTO 2** = When the lower rotary switch is in this position, the local advanced automatic reversing system for Venetian blinds is completely switched off.

**AUTO 3** = When the lower rotary switch is in this position, the local advanced automatic reversing system for Venetian blinds is switched off as well. The central control inputs A5 and A6 though, which are dynamic at AUTO 1 and AUTO 2, **are static at first, thus, allow reversal of Venetian blinds by operating push-buttons.** They only switch to dynamic after 1 second continuous operation.

▲▼ = ▲ (UP) and ▼ (DOWN) of the lower rotary switch are the positions for manual control. Manual control has priority over all other control commands.

**WA = Automatic reversal** for Venetian blinds and awnings is controlled by means of the middle rotary switch. 0 = OFF, otherwise from 0.1 to 5 seconds ON with selected reversal time. In this case, it is only for DOWN that the direction is reversed on time-out of the time lag selected by means of the top rotary switch, e.g. to extend awnings or set Venetian blinds to a defined position.

**RV = The time delay** (delay time RV) is set by means of the top rotary switch. If, the group impulse switch is in the UP or DOWN position the selected delay time runs (elapses); at time-out the device changes automatically to STOP. Therefore, the time delay must be chosen at least as long as the shading element or roller shutter will need to move from one limit position to the other. The LED indication for the delay times WA and RV is located behind this rotary switch.

**Local control with push-button** connected to terminals A3 + A4 (to be connected with a bridge). Each impulse causes the group impulse switch to change its position in the UP-Stop-DOWN-Stop sequence.

**Local control with roller shutter toggle switch** connected to terminals A3 and A4.

**Local control with dual roller shutter push-button** connected to A5 and A6. The 'UP' or 'DOWN' position is activated with an impulse by push-button. A further impulse from one of the two push-buttons stops the sequence immediately.

**Central control dynamic** without priority connected to terminals A5 (UP) and A6 (DOWN). Up or DOWN is activated by a control signal. A further control signal (< 700ms) at this control input interrupts this process immediately, a further control signal (> 700ms) continues the process. **This is without priority** because the local input A3 + A4 (with bridge) and the central control inputs A7 and A8 can immediately override even whilst the control contact on A5 or A6 is still closed.

**Central control dynamic with priority** connected to terminals A7 (UP) and A8 (DOWN). **With priority** because these control inputs cannot be overridden by other control inputs **as long as** the central control contact is closed. Otherwise it has the same function as the central control dynamic without priority. These central control inputs A7 and A8 are used for the sensor relays MSR12 and LRW12D for the wind sensor, the frost sensor and the rain sensor functions as these are required to have absolute priority over other sensor commands.

Technical data page H7.

Connection example page H10.

Housing for operating instructions GBA12 page Z5.

## EGS12Z2-8..230V UC

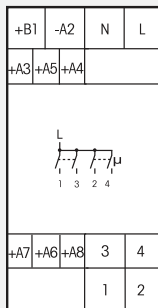

**Impulse group switch for central control, 2+2 NO contacts not potential free 5 A/250 V AC, for two 230V-motors. Standby loss 0.05–0.9 watt only.**

Modular device for DIN 60715 TH35 rail mounting. 2 modules = 36 mm wide, 58 mm deep. Supply voltage 8..230V UC at terminals +B1/-A2. The control voltage at terminals A3 up to A8 must have an identical potential.

This impulse group switch serves to implement commands generated by the sensor relays or by switches and push-buttons and controls two 230V motors according to the setting of the rotary switches on the front.

1/2 = motor 1, 3/4 = motor 2.

**The mode of operation corresponds completely to the impulse group switch EGS12Z on page H4 in which a MTR12 as described below is integrated.**

Technical data page H7. Connection example page H9. Housing for operating instructions GBA12 page Z5.

**EGS12Z2-8..230V UC**

2 + 2 NO 5 A

EAN 4010312108031

**80,90 €/pc.**

## MTR12-8..230V UC

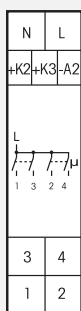

**Motor isolating relay, 2+2 NO contacts not potential free 5 A/250 V AC for one or two 230V-motors. Standby loss 0.5 watt only.**

Modular device for DIN 60715 TH35 rail mounting.

1 module = 18 mm wide, 58 mm deep.

Universal control voltage 8..230V UC. 230V supply voltage.

The tube-mounted motors of shading elements and roller shutters must not be connected in parallel, or reverse voltages will occur through the limit switches, ultimately causing failure of the motors.

For one motor and if the control voltage and the motor voltage are 230V, one EGS12Z is adequate. Where more than one motor is controlled by an EGS12Z or in case the control voltage is different, one MTR12 must be connected to two motors. It must be remembered that the MTR12 devices, while they can be operated in parallel, require unassigned contact outputs K2/K3 of the controlling EGS12Z. These have to be connected to terminals K2/K3 of the MTR12. 1/2 = motor 1, 3/4 = motor 2.

The functions UP and DOWN may be blocked or switched off entirely by a rotary switch. This block applies only to the max. 2 connected motors. Therefore single shading elements or roller shutters can be completely or partially excepted from the automatic function of an over-all control.

Technical data page H7. Housing for operating instructions GBA12 page Z5.

**MTR12-8..230V UC**

2 + 2 NO 5 A

EAN 4010312205211

**57,80 €/pc.**

## DCM12-8..230V UC

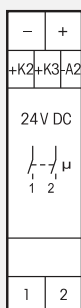

**DC motor relay, 2 NO contacts not potential free 24 V DC/90Watt, for one 24 V DC motor. Standby loss 0.07 watt only.**

Modular device for DIN 60715 TH35 rail mounting.

1 module = 18 mm wide, 58 mm deep.

Universal control voltage 8..230V UC. 24 V DC supply voltage.

The DCM12 can be operated in parallel, but they require unassigned contact outputs K2/K3 of the controlling EGS12Z. These have to be connected to terminals K2/ K3 of the DCM12.

The functions UP and DOWN may be blocked or switched off entirely by a rotary switch. This block applies only to the 1 connected motor. Therefore single shading elements or roller shutters can be completely or partially excepted from the automatic function of an over-all control.

Technical data page H7. Housing for operating instructions GBA12 page Z5.

**DCM12-8..230V UC**

2 NO 90 W

EAN 4010312205310

**57,80 €/pc.**

H5

# Actuators EGS61Z and MTR61

## EGS61Z-230V

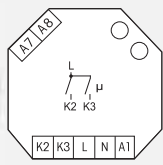

**Impulse group switch for central control, 1 + 1 NO contacts not potential free 10A/250V AC, for one 230V AC motor. Standby loss 0.4 watt only.**

For installation. 45mm long, 55mm wide, **32mm deep**.

State-of-the-art hybrid technology combines advantages of nonwearing electronic control with high capacity of special relays.

This impulse group switch serves to implement commands generated by the sensor relays or by switches and push-buttons and controls a 230V motor for a shading element or a roller shutter.

230V control voltage, supply voltage and switching voltage.

**By using bistable relays coil power loss and heating is avoided even in the on mode.**

The switched consumer may not be connected to the mains before the short automatic synchronisation after installation has terminated.

By push-button at A1 impulse control is used to obtain UP-Stop-DOWN-Stop. Additional control inputs A7 and A8 can be used for central control UP or DOWN with priority.

A1, A7 and A8 need the same potential as L.

**With priority** because these control inputs cannot be overridden by other control inputs **as long as** the central control contact is closed. Up or DOWN is activated by a control signal. A further control signal (< 700ms) at this control input interrupts this process immediately, a further control signal (> 700ms) continues the process.

The time delay (delay time RV) is set by means of the rotary switch **RV**. If the group impulse switch is in the UP or DOWN position the selected delay time runs (elapses); at time-out the device changes automatically to STOP. Therefore, the time delay must be chosen at least as long as the shading element or roller shutter will need to move from one limit position to the other.

With the rotary switch **WA** automatic reversal is controlled: in the setting from 0.5 to 2 sec. reversal time the automatic reversal is activated. In this case, it is only for DOWN that the direction is reversed on time-out of the time lag selected by means of the top rotary switch RV, e.g. to extend awnings or set Venetian blinds to a defined position.

**AUTO 1:** No automatic reversal and no local advanced automatic reversing system.

A7 and A8 operation < 1s → static process (contact closes only during operation)

operation > 1s → dynamic process (contact remains closed), stop command by new operation.

**AUTO 2:** Automatic reversal with 1s reversal time. Additionally the local advanced automatic reversing system for Venetian blinds at A1 is active: a double impulse activates a slow rotation in the opposite direction, which can be stopped with a further impulse.

### Function rotary switches

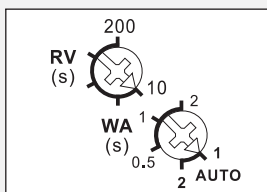

Standard setting ex factory.

### Typical connection

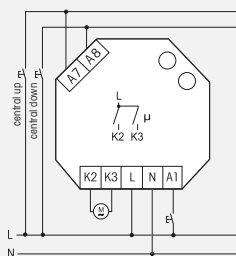

Technical data page H7. Short-stroke pushbuttons page Z1-Z3.

**EGS61Z-230V**

1 + 1 NO 10A

EAN 4010312108123

**53,50 €/pc.**

**NEW**

## MTR61-230V

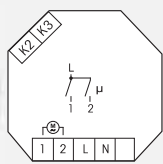

**Motor isolating relay, 1 + 1 NO contacts not potential free 10A/250V AC, for one 230V AC motor. Standby loss 0.4 watt only.**

For installation. 45mm long, 55mm wide, **32mm deep**.

State-of-the-art hybrid technology combines advantages of nonwearing electronic control with high capacity of special relays.

This actuator implements the instructions of the EGS61Z and switches a 230V motor for a shading element or a roller shutter at 1-2. Therefore connect the motor connections K2-K3 of the EGS61Z with the K2-K3 connections of one or several MTR61.

230V control voltage, supply voltage and switching voltage.

Technical data page H7.

**MTR61-230V**

1 + 1 NO 10A

EAN 4010312206577

**48,80 €/pc.**

Recommended retail prices excluding VAT.

Contacts	EGS12Z <sup>b)</sup>	EGS12ZZ <sup>b)</sup>	EGS61Z <sup>b)</sup> MTR61 <sup>b)</sup>	LRW12D/MSR12 <sup>1)</sup>	MTR12/DCM12
Contact material/contact gap	AgSnO <sub>2</sub> / 0.5 mm	AgSnO <sub>2</sub> / 0.5 mm	AgSnO <sub>2</sub> / 0.5 mm	OptoMOS	AgSnO <sub>2</sub> / 0.5 mm
Spacing of control connections/contact	3 mm	3 mm	3 mm	3 mm/6 mm	3 mm
Test voltage as per VDE 0110 control connection/contact	2000 V	2000 V	2000 V	LRW12D: 2000 V MSR12: 4000 V	2000 V
Rated switching capacity	16 A/250V AC	5 A/250V AC	10 A/250V AC	50 mA/8...230V UC	5 A/250V AC DCM: 90W
Inductive load cos φ = 0.6/230V AC inrush current ≤ 35A	650W	650W <sup>2)</sup>	650W	–	MTR12: 650W <sup>2)</sup>
Life at rated load, cos φ = 0.6	>4x10 <sup>4</sup>	>4x10 <sup>4</sup>	>4x10 <sup>4</sup>	–	>4x10 <sup>4</sup>
Switch position indication	WA and RV	WA and RV	–	LED	LED
Maximum conductor cross-section (3-fold terminal)	6 mm <sup>2</sup> (4 mm <sup>2</sup> )	6 mm <sup>2</sup> (4 mm <sup>2</sup> )	4 mm <sup>2</sup>	6 mm <sup>2</sup> (4 mm <sup>2</sup> )	6 mm <sup>2</sup> (4 mm <sup>2</sup> )
Two conductors of same cross-section (3-fold terminal)	2.5 mm <sup>2</sup> (1.5 mm <sup>2</sup> )	2.5 mm <sup>2</sup> (1.5 mm <sup>2</sup> )	1.5 mm <sup>2</sup>	2.5 mm <sup>2</sup> (1.5 mm <sup>2</sup> )	2.5 mm <sup>2</sup> (1.5 mm <sup>2</sup> )
Screw head	slotted /crosshead, pozidriv	slotted /crosshead, pozidriv	slotted /crosshead	slotted /crosshead, pozidriv	slotted /crosshead, pozidriv
Type of enclosure/terminals	IP50 / IP20	IP50 / IP20	IP30 / IP20	IP50 / IP20	IP50 / IP20
<b>Electronics</b>					
Time on (also for central on/off)	100%	100%	100%	100%	100%
Max./min. temperature at mounting location	+50°C/-20°C	+50°C/-20°C	+50°C/-20°C	+50°C/-20°C	+50°C/-20°C
Standby loss (active power) at 230V	0.4 W	0.9 W	0.4 W	LRW12D: 0.5 W MSR12: –	MTR12: 0.5 W
Standby loss (active power) at 24 V	0.1 W	0.1 W	–	LRW12D: 0.1 W MSR12: 0.5 W	DCM12: 0.07 W
Standby loss (active power) at 12V	0,05 W	0,05 W	–	LRW12D: 0,05 W MSR12: –	–
Control current A1 or A3-A8 at 12/24/230V ± 20%	0.05/0.11/0.7 mA	0.05/0.11/0.7 mA	–/–/0.7 mA	–	0.1/0.2/1 mA
Max. parallel capacitance (approx. length) of control lead at 230 V AC	0.06 μF (200 m)	0.06 μF (200 m)	0.3 μF (1000 m) MTR61: 0.06 μF (200 m)	–	0.3 μF (1000 m)
Min. command duration	50 ms	50 ms	50 ms	–	–

<sup>b)</sup> Bistable relay as relay contact. Do not connect the switched consumer to the mains before the short automatic synchronisation after installation has terminated.

<sup>1)</sup> After installation and after a power failure the multisensor needs approx. 1 minute before the wind sensor is active. During this process the outputs wind and sun of the MSR12 are blocked and 3 LEDs flash slowly.

<sup>2)</sup> Inductive load cos φ = 0.6 as sum of both contacts 1000W max.

If necessary, see the operating instructions of the appropriate shading elements for the maximum wind speed that can be set for the sensor relays.

m/s	4	6	8	10	12	14	16
km/h	14.4	21.6	28.8	36.0	43.2	50.4	57.6
Bff	3	4	4	5	6	7	7

Do not route measurement leads parallel to other electrical lines - measurement leads must be screened statically if longer than 10 m. For example JY-ST-Y. To extend leads use screw terminals and damp-proof connectors.

When selecting an installation site for light, wind and multi sensors, ensure that the sensors are not in the shadow of the objects being monitored.

# Typical Circuit Example of a Shading System Control

## With multifunction sensor relay MSR12

For clarity, the L and N connections are not shown. Similarly, provision made for local control through A3 and A4 are not shown.

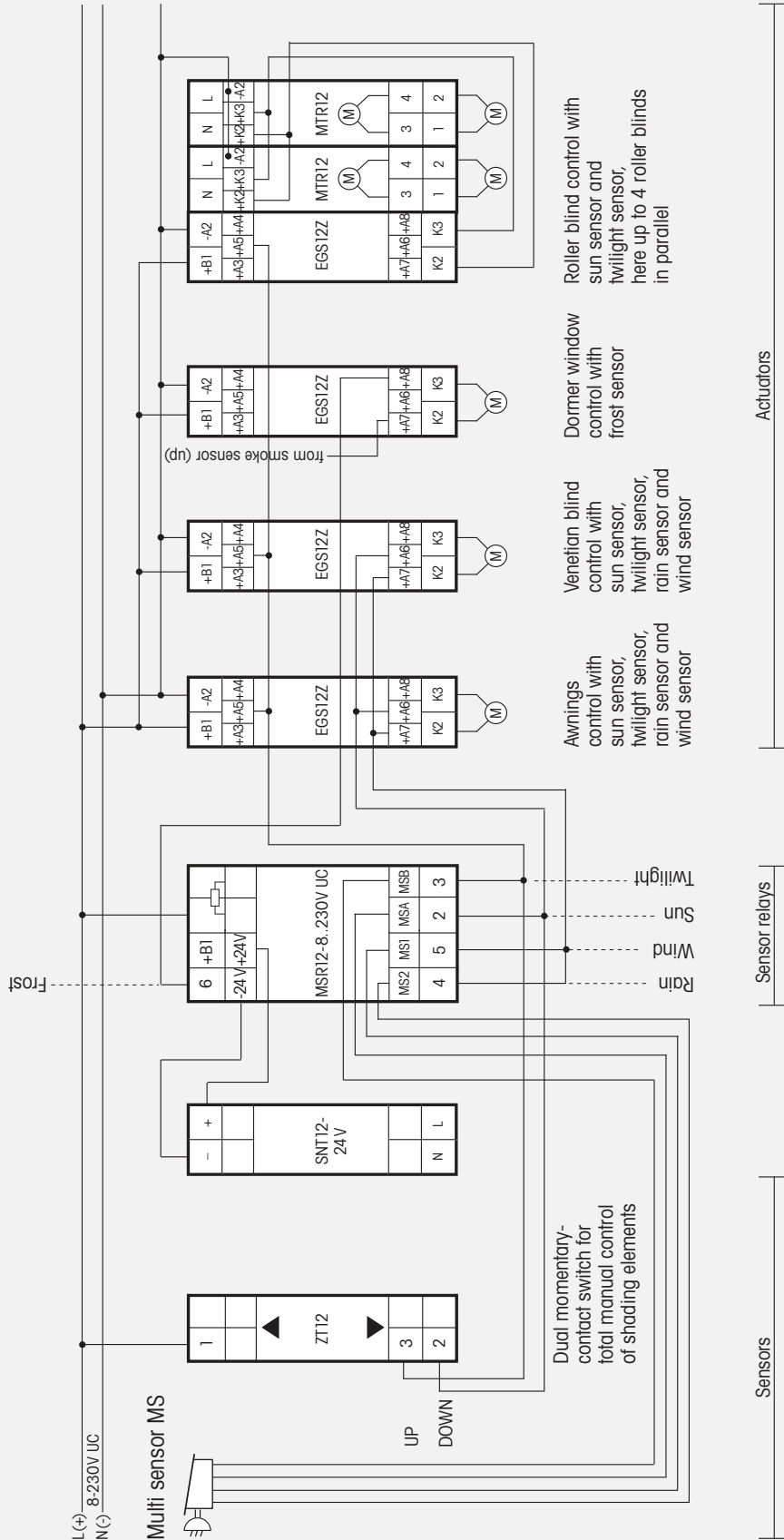

When controlling with 230V (+B1=L, -A2=N) the 230V motors are directly connected to K2, K3 and N. Otherwise motor isolating relays MTR12 must be interconnected to K2/K3.

A night time window can be set with the **digital time switch DW12-001-230V** so that the multi sensor does not cause any disturbance. To do this, program the changeover as follows: in the daytime the terminal +B1 of MSR12 connect to L(+) and at night time L(-) direct to terminal 3 of MSR12. This simulates twilight at the beginning of the time window in order to open all shading elements and at the same time all sensors are switched off.

## Shading system with the light, twilight, rain and wind sensor relay LRW12D

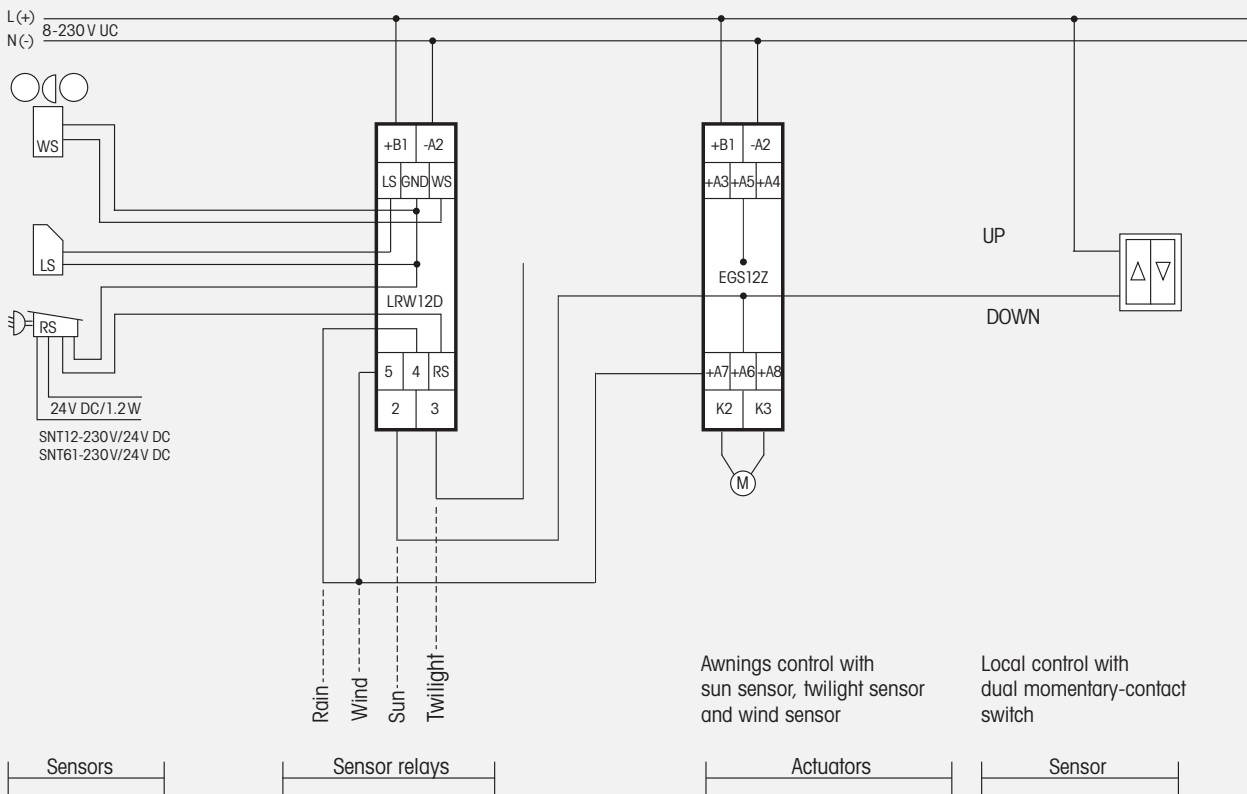

When controlling with 230V (+B1= L, -A2=N) the 230V awning motor is directly connected to K2, K3 and N. Otherwise a motor isolating relay MTR12 must be interconnected to K2/K3.

## Roller shutter control with EGS12Z2

For clarity, the L and N connections for the 230V motors are not shown.

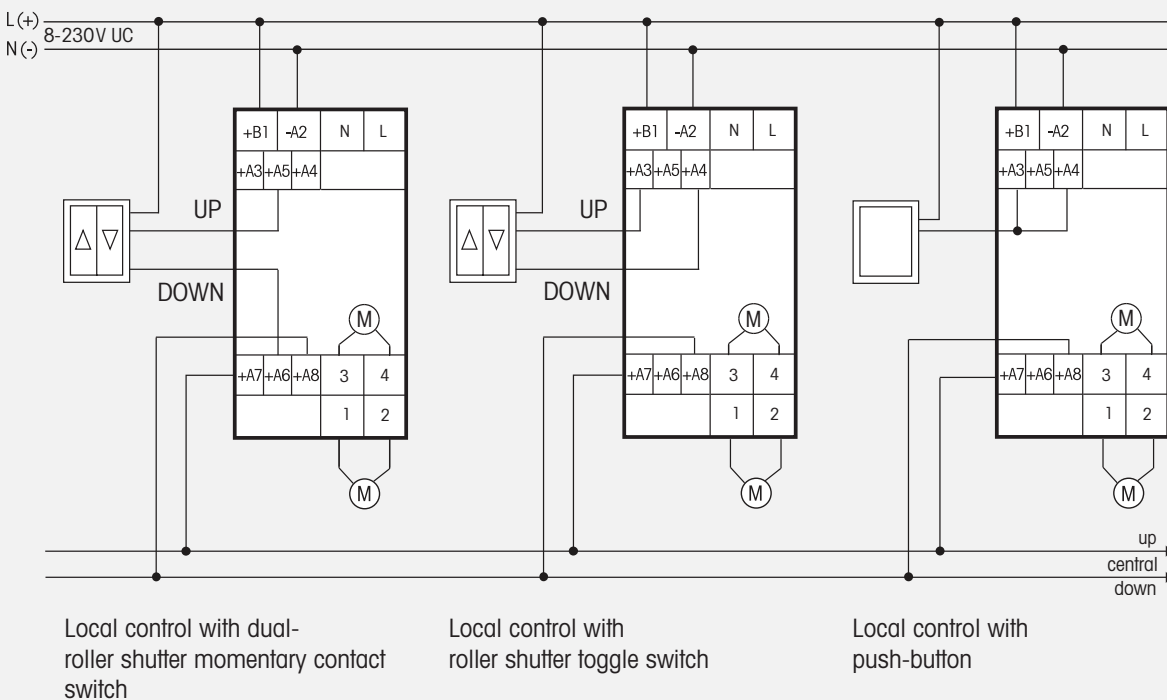

## Roller shutter control with EGS12Z

For clarity, the L and N connections for the 230V motors are not shown.

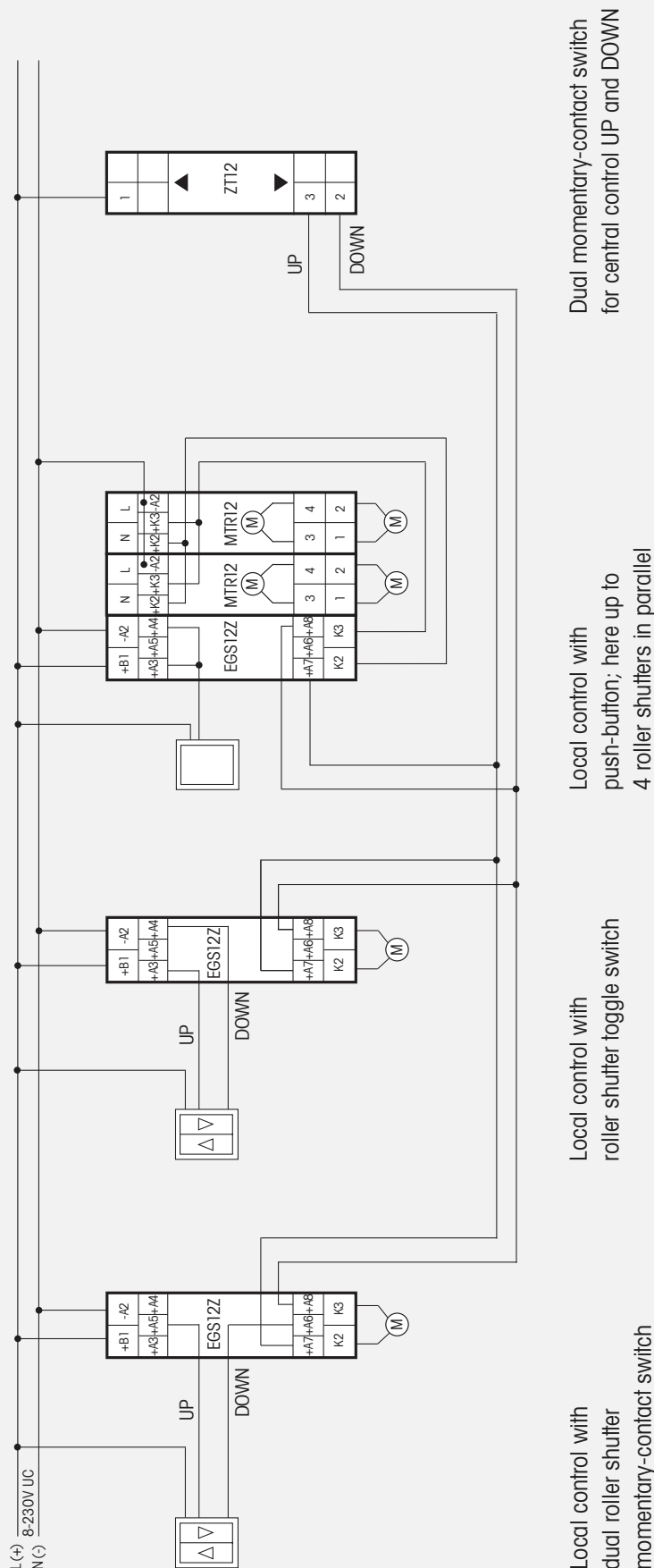

Local control with dual roller shutter momentary-contact switch

Local control with roller shutter toggle switch

Local control with push-button; here up to 4 roller shutters in parallel

Dual momentary-contact switch for central control UP and DOWN

Using a week time switch with 1 CO the roller shutter control can be automated time-dependent by programming the changeover as follows: in the daytime terminal +A3 must be connected to L(+) and at night time switching over to +A4. All other control inputs except the local control with a push-button stay active for local and central control.

Using the light, twilight, rain and wind sensor relay LRW12D-UC the roller shutter control can be automated brightness-dependent by connecting terminal +A5 of the EGS12Z to the output 2 of the LRW12D and terminal +A6 with the output 3. All other control inputs stay active for local and central control.