



The Energy Savers





Selection table for universal dimmer switches, capacity enhancer and 1-10V controllers	B0
Universal dimmer switch EUD12NPN , also for 230V LED lamps	B1
Universal dimmer switch for central control EUD12Z , also for ESL	B2
Multifunctions universal dimmer switch EUD12D with display	B3
Universal dimmer switch for mains disconnection switching EUD12F	B4
Capacity enhancer for universal dimmer switches LUD12 , also for 230V LED lamps	B5
NEW Digitally adjustable motor dimmer MOD12D-UC	B7
NEW Fully electronic multifunction time relay MFZ12PMD-UC	B8
1-10V control dimmer switch for electronic ballast units SDS12	B9
1-10V controller for universal dimmer switches SUD12	B10
Universal dimmer switch EUD61NP without N connection	B11
Universal dimmer switch EUD61NPN , also for 230V LED lamps	B12
Multifunctions universal dimmer switch EUD61M	B13
NEW LED dimmer switch 12-36V DC ELD61	B14
1-10V control dimmer switch for electronic ballast units SDS61	B15
Technical data	B16

Selection Table for Universal Dimmer Switches, Capacity Enhancer and 1-10V Controllers

B0

The Energy Savers

Set the mood and reduce energy costs at the same time - a fascinating combination for incandescent lamps, halogen lamps and LED lamps. The dimming of lamps in combination with soft ON and soft OFF, prolongs their lifetime considerably. This applies also to the new infinitely dimmable energy saving lamps. Only universal dimmers with the marking R, L, C recognize automatically the connected load and adjust their dimming function accordingly. Other dimmers have to be exchanged if lamps with other kind of loads are used later. Only dimmer switches with additional ESL marking are optimized for dimmable energy saving lamps. Only universal dimmer switches with an additional LED marking are optimized for dimmable LED lamps.

Page		B1	B2	B3	B4	B5	B7	B8	B9	B10	B11	B12	B13	B14	B15
	pictograms	EUD12NPN	EUD12Z-UC	EUD12D-UC	EUD12F	LUD12-230V	MOD12D-UC	MFZ12PMD-UC	SDS12/1-10V	SUD12/1-10V	EUD61NP-230V	EUD61NPN-UC	EUD61M-UC	ELD61/12-36V DC	SDS61/1-10V
Modular device for DIN EN 60715 TH35 rail mounting, number of modules 18 mm each		1	1	1	1	1	1	1	1	1					
Built-in device for installation (e.g. flush-mounting box) and surface mounting											■	■	■	■	■
Dimming R, L and C loads		■	■	■	■	■ ⁵⁾	L loads	■	1-10V EVG*	■ ⁷⁾	■	■	■		1-10V EVG*
Optimized dimming function for dimmable energy saving lamps ESL		■	■	■	■	■						■	■		
Optimized dimming function for dimmable LEDs		■				■		■				■		■	
Power MOSFET up to 400W (nearly unlimited number of switching cycles)		■	■	■	■ ¹⁾	■	■ ¹⁾	■		■ ⁷⁾	■ ⁸⁾	■	■	4A	
Increase of capacity with capacity enhancer LUD12-230V			■	■				■		■ ⁷⁾					
Zero passage switching		■	■	■	■	■	■	■	■	■	■	■	■		■
Minimum brightness level adjustable		■		■	■	■ ⁶⁾	■	■	■	■ ⁶⁾	■	■	■	■	
Universal control voltage 8 to 230V UC		■	■	■		■ ⁶⁾	■	■	■	■ ⁶⁾		■	■	■	
Supply voltage 230V		■	■	■	■	■	■	■	■	■	■	■	■		■
Low standby loss		■	■	■	■	■	■	■	■	■	■	■	■	■	■
Glow lamp current (mA) ^{2) 4)}		5	5 ³⁾	5 ³⁾		5 ⁶⁾		5							
Central control electrically isolated from the local input			■	■		■ ⁶⁾	■	■	(■)	■ ⁶⁾					
Switching operation for children's rooms		■	■	■	■	■ ⁶⁾			■	■ ⁶⁾	■	■	■	■	■
Snooze function		■	■	■	■	■ ⁶⁾			■	■ ⁶⁾	■	■	■	■	■
Multifunction				■				■		■ ⁶⁾			■		

* EVG = electronic ballast units

¹⁾ Power MOSFET 300W.

²⁾ Applies to glow lamps with 170V ignition voltage, for glow lamps with 90V ignition voltage approx. 1/2 glow lamp current.

³⁾ Depends on the set function.

⁴⁾ Will automatically be switched on from 110V control voltage.

⁵⁾ Same load as main dimmer switch or separate R, L or C load, depending on circuit.

⁶⁾ This specification refers to EUD12Z or EUD12D, which is connected in series.

⁷⁾ This specification refers to the connected EUD12D, EUD12Z or LUD12 depending on the selected mode.

EUD12NPN-UC



Power MOSFET up to 400W. Energy saving lamps ESL up to 100W and LED up to 100W. Standby loss 0.1 watt only. With adjustable minimum or maximum brightness and dimming speed. With switching operation for children's rooms and snooze function.

Modular device for DIN EN 60715 TH35 rail mounting.
1 module = 18 mm wide, 58mm deep.

Universal dimmer switch for R, L and C loads up to 400 watts, depending on ventilation conditions. Dimmable energy saving lamps ESL up to 100 watts and dimmable 230V LED lamps up to 250 watts. Automatic detection of load R+L or R+C. ESL and LED is manually settable. No minimum load required.

Zero passage switching with soft start and soft OFF to protect lamps.

Universal control voltage input 8 to 230 V UC, electrically isolated from the 230V supply voltage and switching voltage.

Short-time control commands switch on/off, permanent control varies the brightness to the maximum level.

An interruption of control changes the direction of dimming.

The setting of the brightness level is stored after switching off.

In case of a power failure the switching position and the brightness level are stored.

If applicable the dimmer will be switched on at the stored brightness level after the supply voltage is recovered.

Glow lamp current up to 5 mA starting at 110V.

Automatic electronic overload protection and over-temperature switch-off.

The LED below the rotary switch on the front shows control commands. It starts blinking after 15 seconds if a pushbutton is inhibited.

In operation, **the top rotary switch** determines the load type to which the dimming curve is set.

Position R, L, C is the setting for all load types except for ESL and LED. In particular for 230V glow and halogen lamps. Automatic detection of load type inductive or capacitive.

The settings +ESL and -ESL consider the special conditions regarding dimmable energy saving lamps: The starting operation is optimized and adapted to the dimming curve. In these settings the special switching operation for children's rooms is not possible and no wound (inductive) transformer must be dimmed. In position -ESL Memory is switched off. This can be of advantage for energy saving lamps because cold energy saving lamps require a higher minimum brightness as it will possibly be stored in Memory for warmer energy saving lamps.

The position LEDs take account of special conditions with dimmable 230V LED lamps: A number of different dimming curves are available. An updated list with dimming curve assignment for commercially available dimmable 230V LED lamps is ready for downloading at www.eltako.com/dimming_curve/LED_gb.pdf. In these settings no wound (inductive) transformer must be dimmed.

The minimum brightness level (completely dimmed down) or the maximum brightness level (completely dimmed up) is adjustable with the middle **%** rotary switch.

The dimming speed can be adjusted **with the lower dimming speed rotary switch**.

The duration of soft start and soft OFF is changed simultaneously.

With special switching operation for children's rooms: If the light is switched on by holding down the pushbutton, it starts at the lowest brightness level after approx. 1 second and dims up slowly as long as the pushbutton is held down without modifying the last stored brightness level.

Snooze function: With a double impulse the lighting is dimmed down from the current dimming position to the minimum brightness level and switched off. The current dimming position as well as the adjustable minimum brightness level determine the dimming time (max. = 60 minutes) which can be reduced as required. It can be switched off at any time by short-time control commands during the lighting is dimmed down. Holding down the pushbutton during the dimming down process dims up and stops the snooze function.

Mixing of L loads (inductive loads, e.g. wound transformers) and C loads (capacitive loads, e.g. electronic transformers) is not permitted. R loads (ohmic loads, e.g. 230V incandescent lamps and halogen lamps) may be added anytime.

Mixing of L loads and C loads is possible with dimmer switches **EUD12Z** (description page B2) and **EUD12D** (page B3) in connection with capacity enhancer **LUD12** (page B5).

Function rotary switch

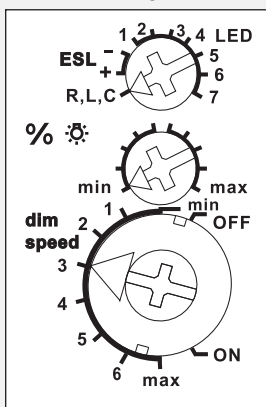

Typical connection

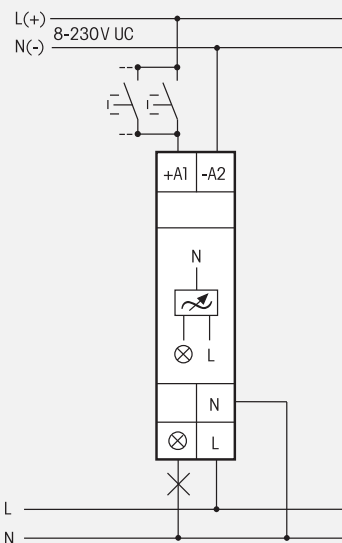

Technical data page B16. Housing for operating instructions GBA12 page Z5.

EUD12NPN-UC

Power MOSFET up to 400W

EAN 4010312107843

54,30 €/pc.

Recommended retail prices excluding VAT.

EUD12Z-UC

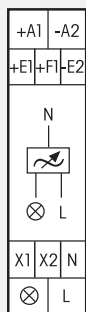

Power MOSFET up to 400W. Energy saving lamps ESL up to 100W. Standby loss 0.1 watt only. With adjustable minimum brightness and dimming speed. With switching operation for children's rooms and snooze function.

Modular device for DIN EN 60715 TH35 rail mounting. 1 module = 18mm wide, 58mm deep. Universal dimmer switch for R, L and C loads up to 400W, depending on ventilation conditions. Dimmable energy saving lamps ESL up to 100 watts. Automatic detection of load R+L or R+C. ESL is manually seffable.

Zero passage switching with soft start and soft OFF to protect lamps.

Up to 3400W with capacity enhancers LUD12-230V (description page B5) at the terminals X1 and X2. Universal voltage control input from 8 to 230V UC and additionally the universal voltage control inputs 8 to 230V UC central ON and central OFF. The control inputs are electrically isolated from the 230V supply voltage and switching voltage.

Short-time control commands switch on/off, permanent control varies the brightness to the maximum level. A interruption of control changes the direction of dimming. The setting of the brightness level is stored after switching off. Glow lamp current up to 5 mA starting at 110V (not for priorities 4 and 8). Automatic electronic overload protection and over-temperature switch-off. The LED below the upper rotary switch on the front indicates a local or central control. During local control it starts blinking after 15 seconds if a pushbutton is inhibited.

With the top rotary switch either the dimming speed is adjustable in five steps or the minimum brightness on energy saving lamps ESL is adjustable in four steps.

The settings +ESL and -ESL consider the special conditions regarding dimmable energy saving lamps: The starting operation is optimized and adapted to the dimming curve. In these settings the special switching operation for children's rooms is not possible and no wound (inductive) transformer must be dimmed. In position -ESL Memory is switched off. This can be of advantage for energy saving lamps because cold energy saving lamps require a higher minimum brightness as it will possibly be stored in Memory for warmer energy saving lamps.

This impulse dimmer switch can be operated completely or partially as central control device.

The middle rotary switch adjusts the central control.

ZE+ZA = central ON and central OFF, ZE = central ON only,

ZA = central OFF only, ~~ZE+ZA~~ = no central control

The lower rotary switch sets several priorities. These determine which other control inputs are inhibited as long as another control input is excited permanently.

Furthermore, here it is decided if the switch position **should be kept or not after a power failure**: In positions 1 to 4 of the rotary switch the switch position remains unchanged, in positions 5 to 8 it is switched off. Incoming central commands are executed immediately after the power supply returns.

OFF = Permanent OFF

1 and 5 = No priority. Also if central control inputs are excited permanently, it is possible to operate the device by pushing a local pushbutton. The last central command is executed. This is the setting ex works.

2 and 6 = Priority for central ON and OFF. Local pushbuttons are temporarily inhibited. However, continuous excitation central OFF has priority over continuous excitation central ON.

3 and 7 = Priority for central ON and OFF. Local pushbuttons are temporarily inhibited. However, continuous excitation central ON has priority over continuous excitation central OFF.

4 and 8 = Priority for permanently excited local pushbutton. In the meantime central commands are not executed. In these positions a glow lamp current is not permitted.

ON = Permanent ON

With special switching operation for children's rooms: If the light is switched on by holding down the pushbutton, it starts at the lowest brightness level after approx. 1 second and dims up slowly as long as the pushbutton is held down without modifying the last stored brightness level.

Function rotary switches

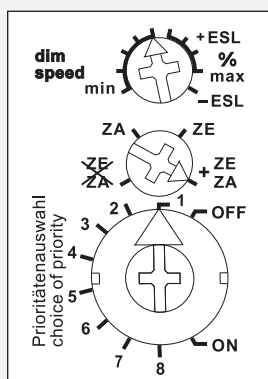

Standard setting ex factory.

Typical connection

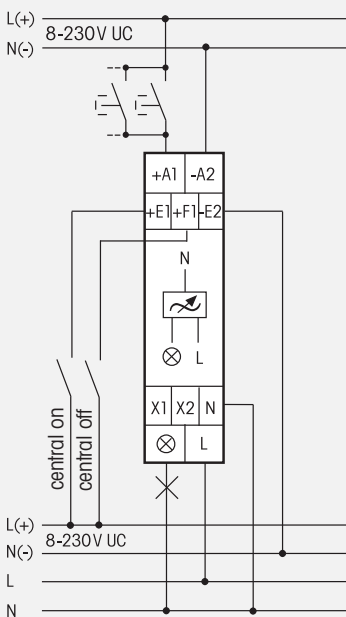

Snooze function: With a double impulse the lighting is dimmed down from the current dimming position and finally switched off. The current dimming position determines the dimming time (max. = 60 minutes) which can be reduced as required. It can be switched off at any time by short-time control commands during the lighting is dimmed down. Holding down the pushbutton during the dimming down process dims up and stops the snooze function.

Mixing of L loads (inductive loads, e.g. wound transformers) and C loads (capacitive loads, e.g. electronic transformers) is not permitted. R loads (ohmic loads, e.g. 230V incandescent lamps and halogen lamps) may be added anytime.

Mixing of L loads and C loads is possible with dimmer switches **EUD12Z** and **EUD12D** (page B3) in connection with capacity enhancer **LUD12** (page B5).

Technical data page B16. Housing for operating instructions GBA12 page Z5.

EUD12Z-UC

Power MOSFET up to 400W

EAN 4010312107850

65,10 €/pc.

Recommended retail prices excluding VAT.

EUD12D-UC

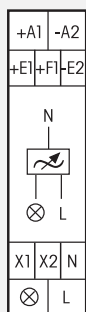

Power MOSFET up to 400W. Energy saving lamps ESL up to 100W and LED up to 100W. Standby loss 0.3 watt only. With adjustable minimum brightness, maximum brightness and dimming speed. With switching operation for children's rooms and snooze function.

Modular device for DIN EN 60715 TH35 rail mounting. 1 module = 18mm wide, 58mm deep. Universal dimmer switch for R, L and C loads up to 400 watt, depending on ventilation conditions. Dimmable energy saving lamps ESL up to 100 watt and dimmable 230V LED lamps up to 100W. Automatic detection of load R+L or R+C. ESL and LED is manually settable.

Up to 3400W with capacity enhancers LUD12-230V (description page B5) at the terminals X1 and X2. Universal control voltage 8 to 230V UC and additionally the universal voltage control inputs 8 to 230 V UC central ON and central OFF. The control inputs are electrically isolated from the supply voltage and switching voltage. **Zero passage switching with soft start and soft OFF to protect lamps.** In case of a power failure the switching position and the brightness level are stored. If applicable the dimmer will be switched on at the stored brightness level after the supply voltage is recovered. From 110V control voltage glow lamp current up to 5 mA (not for DSD). Automatic electronic overload protection and over-temperature switch-off. The functions and times are entered using the MODE and SET keys as described in the operating manual and indicated on the LC display. A keylock function is provided.

EUD = Universal dimmer switch with settings for dimming speed, minimum brightness, maximum brightness, memory and Soft ON/OFF as well as choice of priority for central control same like EUD12Z-UC. ESL and LED is settable. Short-time control commands switch on/off, permanent control varies the brightness to the maximum level. A interruption of control changes the direction of dimming.

The setting ESL considers the special conditions regarding dimmable energy saving lamps: The starting operation is optimized and adapted to the dimming curve. In these settings the special switching operation for children's rooms is not possible and no wound (inductive) transformer must be dimmed. It may be beneficial to switch off the memory on the ESL, because cold energy saving lamps require a higher minimum brightness as it will possibly be stored in Memory for warmer energy saving lamps.

The settings LED take account of special conditions with dimmable 230V LED lamps: A number of different dimming curves are available. An updated list with dimming curve assignment for commercially available dimmable 230V LED lamps is ready for downloading at www.eltako.com/dimming_curve/LED_gb.pdf. In these settings no wound (inductive) transformer must be dimmed.

Switching operation for children's rooms: If the light is switched on by holding down the pushbutton, it starts at the lowest brightness level after approx. 1 second and dims up slowly as long as the pushbutton is held down without modifying the last stored brightness level.

Snooze function: With a double impulse the lighting is dimmed down from the current dimming position to the minimum brightness level and switched off. The current dimming position as well as the adjustable minimum brightness level determine the dimming time (max. = 60 minutes) which can be reduced as required. It can be switched off at any time by short-time control commands during the lighting is dimmed down. Holding down the pushbutton during the dimming down process dims up and stops the snooze function.

DSD = Same as universal dimmer switch EUD but also comprising activation via two direction switches on the universal voltage control inputs 8..230V UC.

ESV = Same as universal dimmer switch EUD but also comprising setting for a time delay from 1 to 99 minutes. Switch-off early warning at the end by dimming is selectable and adjustable from 1 to 3 minutes.

Typical connections

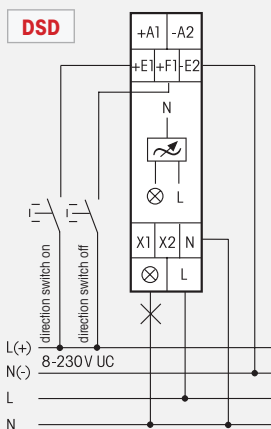
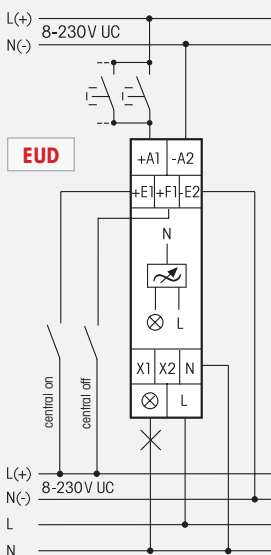

TLZ = Staircase time switch with switchable switch-off early warning by dimming. With pump and permanent light by pushbutton. Time adjustable from 1 to 99 minutes. Switch-off early warning (no flickering) by dimming is adjustable from 1 to 3 minutes. Also for dimmable energy saving lamps ESL and 230V LED lamps. **MIN** = Universal dimmer switch, switches when control voltage is applied to the minimum brightness setting. Maximum brightness is dimmed during the set dim time from 1 to 99 minutes. When the control voltage is interrupted, the device is switched off immediately, even during the dim time. **MMX** = Same function as for **MIN**; when the control voltage is interrupted, dimming still continues until the set minimum brightness is reached. Then the device is switched off. **TI** = Clock with adjustable switch on/off times from 0.1 to 9.9 seconds. The maximum brightness is adjustable from 3 to 99%. **ER** = Switching relay with setting for Soft ON/OFF from 0.1 to 9.9 seconds. The maximum brightness is adjustable from 3 to 99%. **ON** = permanent ON. **OFF** = permanent OFF.

The dim position in % or the time lapse in minutes is indicated in the middle of the display. The expired, resettable switch-on time is indicated at the bottom of the display. Display menu guidance including language selection (German, English, French, Italian or Spanish) is described in the supplied operating manual. Also available online at www.eltako-ba.de.

Technical data page B16. Housing for operating instructions GBA12 page Z5.

EUD12D-UC

Power MOSFET bis 400W

EAN 4010312109489

65,10 €/pc.

Recommended retail prices excluding VAT.

Universal Dimmer Switch EUD12F for mains disconnection switching

B4

EUD12F

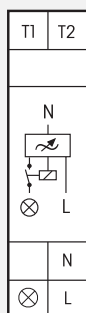

Power MOSFET up to 300W. Energy saving lamps ESL up to 100W. Standby loss 0.1 watt only. With adjustable minimum brightness and dimming speed. With switching operation for children's rooms and snooze function.

Modular device for DIN EN 60715 TH35 rail mounting.
1 module = 18 mm wide, 58 mm deep.

Universal dimmer switch for R, L and C loads up to 300 watt, depending on ventilation conditions. Dimmable energy saving lamps ESL up to 100 watt. Automatic detection of load R+L or R+C. ESL is manually settable.

Zero passage switching with soft start and soft OFF to protect lamps.

Supply voltage and switching voltage 230V.

Short-time control commands switch on/off, permanent control varies the brightness to the maximum level.

An interruption of control changes the direction of dimming.
The setting of the brightness level is stored after switching off.

In case of a power failure the switching position and the brightness level are stored.
If applicable the dimmer will be switched on at the stored brightness level after the supply voltage is recovered.

Automatic electronic overload protection and over-temperature switch-off.

With integrated switching-off relay for the mains disconnection of switched circuits.

The control pushbutton(s) of the room are connected via low voltage control wires to the terminals T1 and T2 of the EUD12F (field-free internal DC voltage). The permanent power supply must be connected directly to a phase conductor **ahead** of the mains disconnection relay FR12-230V. Due to this, the complete function remains but the leads to the lamps is disconnected by means of the switching-off relay. A glow lamp current is not permitted.

The minimum brightness level (completely dimmed down) can be adjusted with **the upper rotary switch** % , e.g. for dimmable energy saving lamps.

The dimming speed can be adjusted **with the lower dimming speed rotary switch**. Simultaneously the soft on and soft off period is changed.

The settings +ESL and -ESL consider the special conditions regarding dimmable energy saving lamps: The starting operation is optimized and adapted to the dimming curve. In these settings the special switching operation for children's rooms is not possible and no wound (inductive) transformer must be dimmed. In position -ESL Memory is switched off. This can be of advantage for energy saving lamps because cold energy saving lamps require a higher minimum brightness as it will possibly be stored in Memory for warmer energy saving lamps.

With special switching operation for children's rooms: If the light is switched on by holding down the pushbutton, it starts at the lowest brightness level after approx. 1 second and dims up slowly as long as the pushbutton is held down without modifying the last stored brightness level.

Snooze function: With a double impulse the lighting is dimmed down from the current dimming position to the minimum brightness level and switched off. The current dimming position as well as the adjustable minimum brightness level determine the dimming time (max. = 60 minutes) which can be reduced as required. It can be switched off at any time by short-time control commands during the lighting is dimmed down. Holding down the push-button during the dimming down process dims up and stops the snooze function.

Mixing of L loads (inductive loads, e.g. wound transformers) and C loads (capacitive loads, e.g. electronic transformers) is not permitted. R loads (ohmic loads, e.g. 230V incandescent lamps and halogen lamps) may be added anytime.

Mixing of L loads and C loads is possible with dimmer switches **EUD12Z** (description page B2) and **EUD12D** (page B3) in connection with capacity enhancer **LUD12** (page B5).

Function rotary switch

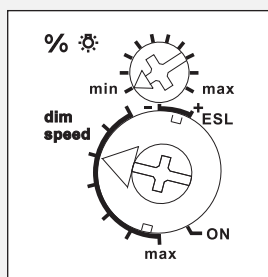

Standard setting ex factory.

Typical connection

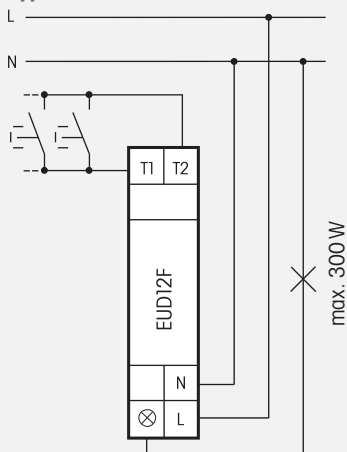

Technical data page B16. Housing for operating instructions GBA12 page Z5.

EUD12F

Power MOSFET 300 W
and switching-off relay

EAN 4010312108086

65,10 €/pc.

Recommended retail prices excluding VAT.

LUD12-230V

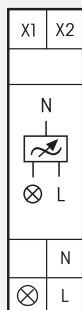

Power MOSFET up to 400 W, ESL up to 100W and 230V LED up to 100W. Standby loss 0.1 watt only.

Modular device for DIN EN 60715 TH35 rail mounting.
1 module = 18 mm wide, 58mm deep.

Capacity enhancers LUD12-230V can be connected to the universal dimmer switches EUD12Z, EUD12D, SUD12 (1-10V) input and FUD12/800W. By this the switching capacity for **one lamp** will be increased according to the below mentioned table depending on ventilation conditions up to 400, 350 or 400W or **alternatively for additional lamps** up to 500W per each capacity enhancer.

Both switching modes for increase of capacity can be executed simultaneously. Automatic detection of load R+L or R+C in the circuit "Increase of capacity with **additional lamps**". Supply voltage 230V.

Automatic electronic overload protection and over-temperature switch-off.

In the mode "Increase of capacity with additional lamps" the kind of load of a capacity enhancer LUD12-230V can vary from the kind of load of the universal impulse dimmer switch.

Therefore it is possible to mix L loads and C loads.

Function rotary switch

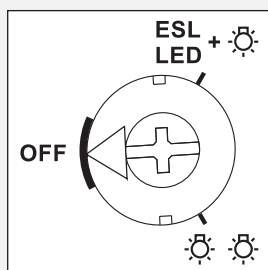

Standard setting ex factory.

The switching mode "one lamp" (☀️) or "additional lamps" (☀️☀️) is set with a rotary switch on the front.

This setting must be same as the actual installation, otherwise there is a risk of destruction of the electronics.

For different setting on ESL and 230V LED lamps, see page B6.

Increase of capacity for one lamp (☀️), ESL and LED see next page

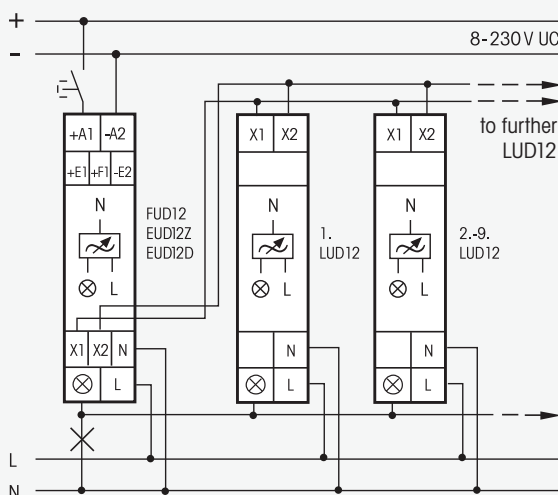

EUD12Z and EUD12D:

- 1. LUD12 + 400W
- 2.-5. LUD12 + 350W each
- 6.-9. LUD12 + 300W each

FUD12/800W:

- 1.-4. LUD12 + 350W each
- 5.-8. LUD12 + 300W each

For the FUD12/800W see the different connection example as per the operating instructions.

Increase of capacity with additional lamps (☀️☀️), ESL and LED see next page

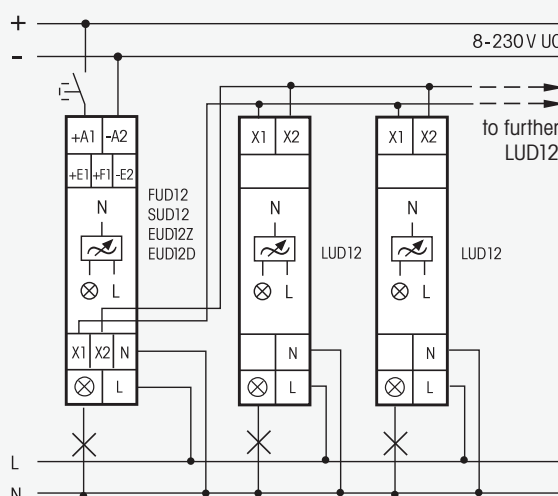

EUD12Z, EUD12D and SUD12:

- 1.-6. LUD12 + 400W each
- 8. LUD12 + 200W

FUD12/800W:

- 1.-6. LUD12 + 400W each
- 7. LUD12 + 200W each

For the SUD12 and the FUD12/800W see the different connection example as per the operating instructions.

Technical data page B16.
Housing for operating instructions GBA12 page Z5.

LUD12-230V

Power MOSFET up to 400W

EAN 4010312107867

62,20 €/pc.

Recommended retail prices excluding VAT.

Capacity Enhancer LUD12 for Universal Dimmer Switches

Increase of capacity for dimmable energy saving lamps ESL and dimmable 230V LED lamps

Function rotary switch

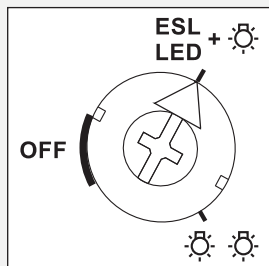

This setting must be made on the front panel on ESL and 230V LED lamps. Also with power increase with additional lamps.

Otherwise there is a risk of destruction of the electronics.

Increase of capacity for one lamp

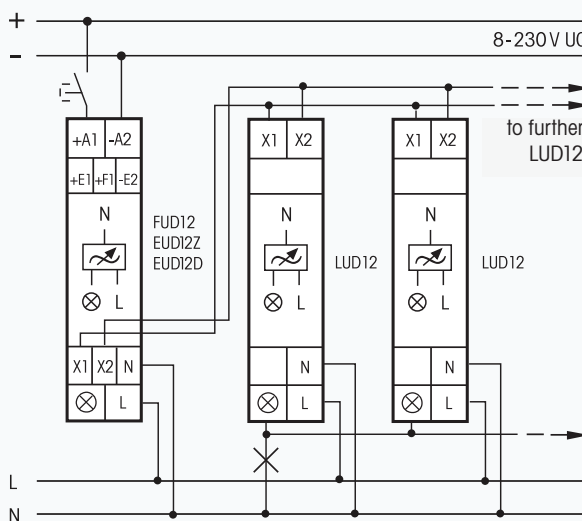

1.-9. LUD12 + 100W each

For the FUD12/800W see the different connection example as per the operating instructions.

Increase of capacity with additional lamps

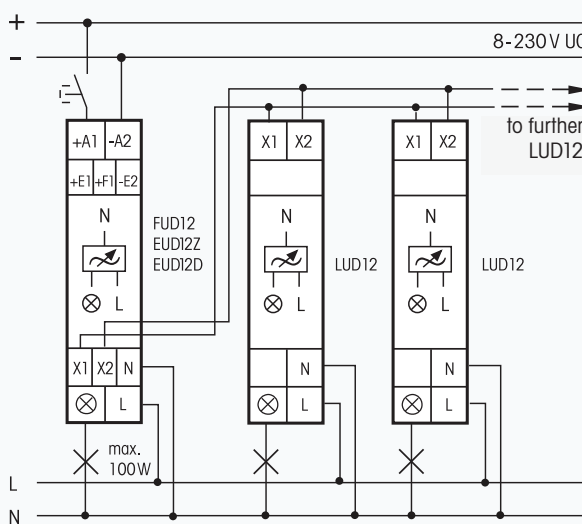

1.-9. LUD12 + 100W each

For the FUD12/800W see the different connection example as per the operating instructions.

Technical data page B16. Housing for operating instructions GBA12 page Z5.

LUD12-230V

Power MOSFET up to 500W

EAN 4010312107867

62,20 €/pc.

Recommended retail prices excluding VAT.

NEW

MOD12D-UC



Power MOSFET up to 300W. Standby loss 0.3 watt only.
Minimal speed, maximum speed and dimming speed are adjustable.

Modular device for DIN EN 60715 TH35 rail mounting.
 1 module = 18mm wide, 58mm deep.

Motor dimmer with phase control for L loads up to 300W, depending on ventilation conditions. Only 1 motor may be connected.

Universal control voltage 8 to 230V UC and additionally the universal voltage control inputs 8 to 230V UC central ON and central OFF. The control inputs are electrically isolated from the supply voltage and switching voltage.

Switching in zero crossing and switch-on at increased speed.

If there is a power failure, the switch position and the speed level are saved. The device can be switched on when the power supply is restored.

Automatic electronic overload protection and over-temperature switch-off.

Enter the 6 functions and times using the MODE and SET keys as described in the operator manual. The functions and times are indicated in the LC display. Other features include language selection and keylock.

The total switch-on time is added and indicated in the bottom line of the display. It can be reset to zero.

The top line shows the parameters during the setting procedure and the active function in service. The left arrow indicates the switch position 'ON' and the right arrow shows the keylock function when applied. During the setting procedure, the middle line shows the parameters set. In service, the middle line indicates the speed between 10 and 99 for the MOD and DSD functions or the remaining time in minutes for the Udo and ODT functions.

MOD = Motor dimmer with settings for dimming speed DSP, minimum speed MI%, maximum speed MA%, memory function MEM+ and selection of the central control inputs ON and/or OFF when activated or deactivated. Short commands switch on/off, permanent activation changes speed. An interruption in activation changes the dimming direction.

DSD = Motor dimmer with activation with two direction buttons for dimming direction. Setting the dimming speed DSP, minimum speed MI%, maximum speed MA% and memory function MEM+. When activation takes place via +E1, a short command switches on. Permanent activation dims up to maximum speed. A double-click immediately dims to maximum speed. When activation takes place via +F1, a short command switches off. Permanent activation dims down to minimum speed. No central control function.

Udo = Motor dimmer as for MOD function with manual on/off. In addition, a time delay time TIM can be set from 1 to 99 minutes. When the time delay expires, the device switches off. Central ON has priority over Central OFF.

ODT = Motor dimmer with run-on switch function with adjustable speed SP%, response lag AV adjustable from 1 to 99 minutes and time delay RV adjustable from 1 to 99 minutes. When the control voltage is applied, the device switches on after the AV time expires. When the control voltage cuts off, the RV time begins. When the RV time expires, the device switches off. No central control function.

ON = Permanent ON at maximum speed, **OFF** = Permanent OFF.

Press MODE and SET briefly and simultaneously to activate the keylock. Then press SET to confirm the flashing LCK. Press MODE and SET simultaneously for 2 seconds to deactivate keylock. Then press SET to confirm the flashing UNL.

Typical connections

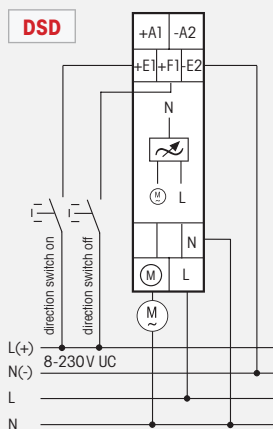
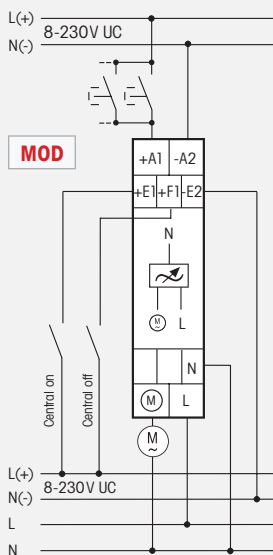

Fully Electronic Multifunction Time Relay MFZ12PMD-UC with 18 functions

B8

MFZ12PMD-UC

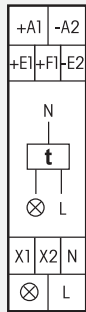

Power MOSFET with almost unlimited number of circuits up to 400W, ESL and LED up to 100W. Standby loss 0.3 watt only. Dim down to minimum brightness and up to maximum brightness and Soft ON / soft OFF are also adjustable for lamp circuit.

Modular device for DIN EN 60715 TH35 rail mounting.
1 module = 18 mm wide, 58 mm deep.

Digitally adjustable and fully electronic multifunction time relay for R, L and C loads up to 400W dependent on ventilation conditions, for dimmable energy saving lamps ESL and dimmable 230V LED lamps up to 100W. Automatic detection of load types R+L or R+C. LED setting LED+ selectable in display. Switching voltage 230V.

If **minimum brightness** is not set to 0, the circuit is not switched off but dimmed down to the set percentage.

Up to 3400W with capacity enhancers LUD12-230V (description page B5) at the terminals X1 and X2. Universal control voltage 8 to 230V UC and additionally the universal voltage control inputs 8 to 230 V UC central ON and central OFF. The control inputs are electrically isolated from the supply voltage and switching voltage.

Zero passage switching to protect lamps.

Glow lamp current up to 5 mA starting at 110V.

Automatic electronic overload protection and over-temperature switch-off.

Enter both the functions and the times using the two buttons MODE and SET. The functions and times are indicated digitally on an LC display. The time can be set by entering all values within the preselected time scale (0.1 to 9.9 or 1 to 99 seconds, minutes or hours). The longest time is 99 hours. This permits 600 time settings. The time(s) entered is (are) permanently displayed digitally.

Settable functions (description page E9): **RV** = release delay, **AV** = operate delay, **AV+** = additive operate delay, **TI** = clock generator starting with impulse, **TP** = clock generator starting with pause, **IA** = impulse-controlled operate delay, **IF** = pulse shaper, **EW** = fleeting NO contact, **AW** = fleeting NC contact, **EAW** = fleeting NO contact and fleeting NC contact, **ARV** = operate and release delay, **ARV+** = additive operate and release delay, **ES** = impulse switch, **SRV** = release-delay impulse switch, **ESV** = impulse switch with release delay and switch-off early-warning function, **ER** = relay, **ON** = permanent ON, **OFF** = permanent OFF. With TI, TP, IA, EAW, ARV and ARV+ functions, a different second time can be entered also with different time ranges.

Typical connection

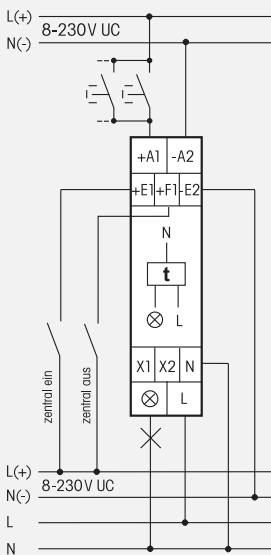

Setting the times and functions: The LCD component to be changed is selected by pressing the MODE key. The component accessed flashes. Press the SET key to change the component accessed. This may be the function, the time ranges, time T1 or time T2 (on TI, TP, IA, EAW, ARV and ARV+ only). Pressing the MODE key terminates each input. Once the time has been set with MODE, no more components are flashing. The timing relay is now ready to operate. Press the MODE key again to restart the input cycle. All the entered parameters are retained if they are not changed using SET. 25 sec. after the last operation and if the component still flashes the input cycle is automatically terminated and the previously made changes lapse.

Setting additional parameters valid for all functions: when you press the MODE button for longer than 2 seconds, you access the submenu. Press the SET button to select the parameter you want to change. Then confirm by pressing MODE. Press SET to enter the parameter and confirm by pressing MODE. After the 'LED' submenu, you return automatically to the main menu.

MIN = Minimum brightness in OFF state settable to 0 and from 10 to 89(%), factory setting = 0.

MAX = Maximal brightness in ON state settable from 10 to 99(%), factory setting = 99. MAX must be at least 10 divisions above MIN.

RMP = Switch ON/OFF ramp (soft ON and soft ON) adjustable from 0 = 10ms to 99 = 1s, factory setting = 0.

LED = LED+ for dimmable 230V LED lamps is activated by pressing the MODE button, factory setting = LED without +.

Functions of the LC display: if you selected the functions ON or OFF, no time is displayed. Instead an arrow indicates either ON or OFF. In all other functions the set time(s), the function abbreviation and an arrow next to ON and OFF display the switching position. The clock symbol flashes while the set time is elapsing and the remaining time is shown.

Safety in the event of a power failure: The set parameters are stored in an EEPROM and are therefore immediately available again when the power supply is restored after a power failure.

Technical data page B16. Housing for operating instructions GBA12 page Z5.

MFZ12PMD-UC

Power MOSFET bis 400W

EAN 4010312601099

65,10 €/pc.

Recommended retail prices excluding VAT.

1-10V Control Dimmer Switch SDS12/1-10V for Electronic Ballast Units

Eltako
ELECTRONICS

SDS12/1-10V

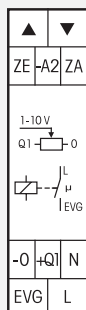
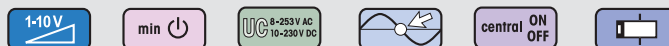

1 NO contact not potential free 600VA and 1-10V control output 40 mA. Only 1 watt standby loss. With adjustable minimum brightness and dimming speed. With switching operation for children's rooms and snooze function.

Modular device for DIN-EN 60715 TH35 rail mounting. 1 modul = 18mm wide, 58mm deep.
Zero passage switching with soft ON and soft OFF to protect lamps.

Universal control voltage 8 to 230V UC, local and central on/off with same potential.
Supply voltage 230V electrically isolated.

State-of-the-art hybrid technology combines advantages of nonwearing electronic control with high capacity of special relays.

The brightness level is stored on switch-off (memory).

In case of a power failure the switch position and the brightness stage are stored and may be switched on when the power supply is restored.

The minimum brightness (fully dimmed) is adjustable with the upper % rotary switch. At the same time, you define whether the children's room function and the snooze function are active (+KI +SL).

The dimming speed is adjustable **using the lower dimming speed rotary switch.**

The load is switched on and off by a bistable relay at output EVG (electronic ballast units).
Switching capacity for fluorescent lamps or LV halogen lamps with electronic ballast units 600VA.

By using a bistable relay coil power loss and heating is avoided even in the on mode. After installation, wait for short automatic synchronisation before the switched consumer is connected to the mains.

Either direction switches can be connected to ▲ ▼ or these terminals are bridged and a pushbutton is connected as universal switch.

As direction switch ▲ is "switch on and dim up" and ▼ is "switch off and dim down".

A double click at ▲ triggers the automatic updimming until full brightness with dim speed. A double click at ▼ triggers the snooze function. The children's room function is realized with the pushbutton at ▲.

As a universal switch, change the direction by briefly releasing the pushbutton.

Switching operation for children's rooms KI (universal switch or direction switch ▲): If the light is switched on by holding down the pushbutton, it starts at the lowest brightness level after approx. 1 second and dims up slowly as long as the pushbutton is held down without modifying the last stored brightness level.

Snooze function SL (universal switch or direction switch ▼): With a double impulse the lighting is dimmed down from the current dimming position to the minimum brightness level and switched off. The current dimming position as well as the adjustable minimum brightness level determine the dimming time (max. = 60 minutes) which can be reduced as required. It can be switched off at any time by short-time control commands during the lighting is dimmed down. Holding down the pushbutton during the dimming down process dims up and stops the snooze function.

Function rotary switches

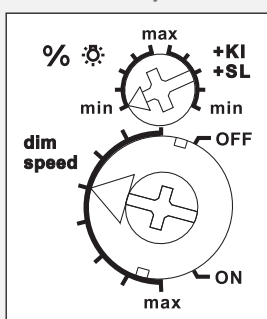

Standard setting ex factory.

Typical connection

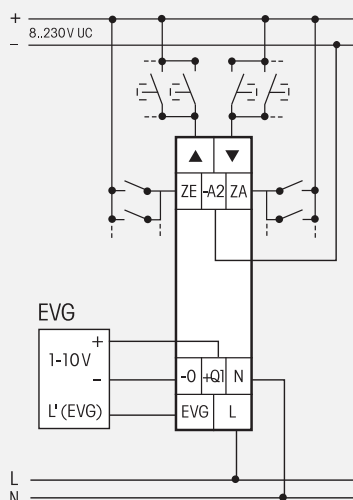

Technical data page B16. Housing for operating instructions GBA12 page Z5.

SDS12/1-10V

1 NO contact 600VA

EAN 4010312109403

50,80 €/pc.

Recommended retail prices excluding VAT.

1-10V Controller SUD12 for Universal Dimmer Switches

SUD12/1-10V



B10

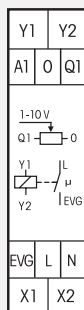

**1 NO contact potential free 600VA and 1-10V control output 40 mA.
Standby loss 0,9 Watt only.**

Modular device for DIN-EN 60715 TH35 rail mounting.
1 module = 18 mm wide, 58 mm deep.

State-of-the-art hybrid technology combines advantages of nonwearing electronic control with high capacity of special relays.

The controller SUD12 can be used in two different modes:

1-10V output

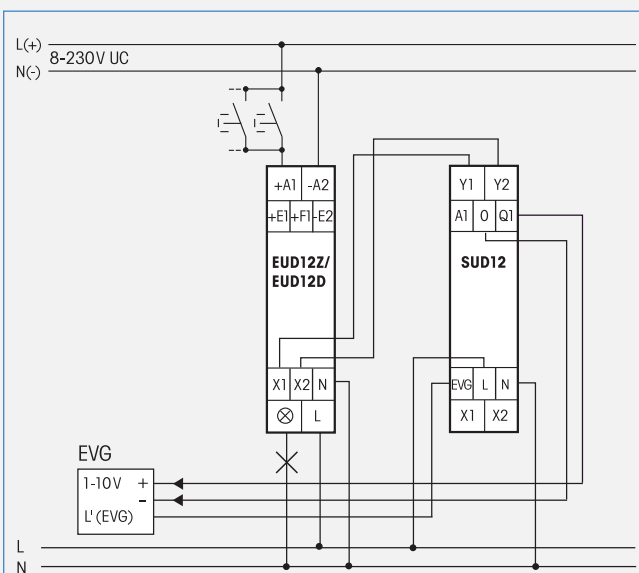

In this mode electronic ballast units and transformers with a 1-10V interface up to a total control current of 40 mA can be controlled when connected to an universal dimmer switch EUD12Z or EUD12D.

The EUD12Z or the EUD12D is controlled with pushbuttons at the universal control voltage input locally or centrally. The SUD12 converts the dimmer signals from Y1/Y2 to the 1-10V output O/Q1 for the interface.

It switches the electronic ballast with a bistable relay at the output EVG (electronic ballast units). **Zero passage switching to protect contacts.** The switching capacity for fluorescent lamps or low voltage halogen lamps with electronic ballast is up to 600VA.

By using a bistable relay coil power loss and heating is avoided even in the on mode.

The switched load may not be connected to the mains before the short automatic synchronisation after installation has terminated.

At the same time a directly dimmable lamp can be connected to the dimmer switch EUD12. Furthermore the dimmer switch EUD12 can be expanded with capacity enhancers LUD12 for directly dimmable lamps as described on page B5.

1-10V input

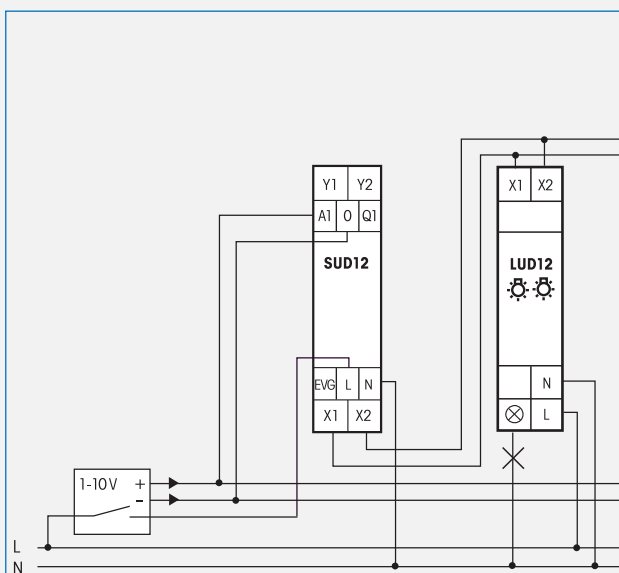

In this mode the output of a 1-10V controller can be converted at A1/O into a direct dimming function when connected to a capacity enhancer LUD12 at terminals X1/X2. The closing operation and the opening operation is also carried out externally at L of the SUD12.

The rotary switch of the LUD12 must be adjusted to the setting (additional lamps).

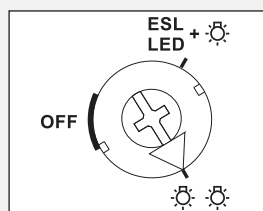

Further capacity enhancers LUD12 in the mode "increase of capacity with additional lamps" can be connected to the controller SUD12 as described on page B5.

A 100K potentiometer for brightness control may also be directly connected to the control input A1/O. If the input A1/O is disconnected the LUD12 dims to maximum brightness.

Technical data page B16. Housing for operating instructions GBA12 page Z5.

SUD12/1-10V

1 NO contact 600VA

EAN 4010312108116

50,80 €/pc.

Recommended retail prices excluding VAT.

EUD61NP-230V

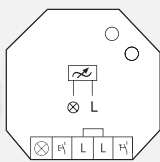

Without N connection, POWER MOSFET up to 400W. Standby loss 0.5 watt only. With control inputs for pushbutton light switches and light switches. With adjustable minimum brightness and dimming speed.

Built-in device for installation. 45 mm long, 55 mm wide, 18 mm deep.

Universal dimmer switch for R, L and C loads up to 400 watt, depending on ventilation conditions. Automatic detection of load R+L or R+C.

Energy saving lamps ESL and 230V LED lamps cannot be controlled by the dimmer type EUD61NP-230V (without N-connection).

Zero passage switching with soft start and soft OFF to protect lamps.

Control voltage 230V. Min. load 40W.

Short-time control commands switch on/off, permanent control varies the brightness up to the maximum level. A short interruption of control changes the direction of dimming.

The brightness level is stored after switching off.

In case of a power failure the switching position and the brightness level are stored.

If applicable the dimmer will be switched on at the stored brightness level after the supply voltage is recovered.

Automatic electronic overload protection and over-temperature switch-off.

The minimum brightness level (completely dimmed down) can be adjusted **with the upper rotary switch %**.

The dimming speed can be adjusted **with the lower dimming speed rotary switch**.

Simultaneously the soft on and soft off period is changed.

If light switches cannot be replaced by pushbutton light switches, there is a separate control input for light switches. If the switch is opened briefly after closing, the light is dimmed until the next time it is opened again briefly. The dimming direction changes automatically at both peaks. The dimming direction can also be changed by opening the switch briefly twice.

Switching operation for children's rooms (only if controlled by pushbutton light switch): If the light is switched on by holding down the pushbutton, it starts at the lowest brightness level after approx. 1 second and dims up slowly as long as the pushbutton is held down without modifying the last stored brightness level.

Snooze function (only if controlled by pushbutton light switch): With a double impulse the lighting is dimmed down from the current dimming position to the minimum brightness level and switched off. The current dimming position as well as the adjustable minimum brightness level determine the dimming time (max. = 60 minutes) which can be reduced as required. It can be switched off at any time by short-time control commands during the lighting is dimmed down. Holding down the pushbutton during the dimming down process dims up and stops the snooze function.

Without N connection, therefore suitable for mounting directly behind the pushbutton light switch or light switch, even if no N wire is available.

Mixing of L loads (inductive loads, e.g. wound transformers) and C loads (capacitive loads, e.g. electronic transformers) is not permitted. R loads (ohmic loads, e.g. 230V incandescent lamps and halogen lamps) may be added anytime.

Mixing of L loads and C loads is possible with dimmer switches **EUD12Z** (description page B2) and **EUD12D** (page B3) in connection with capacity enhancer **LUD12** (page B5).

Function rotary switches

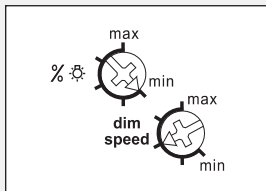

Standard setting ex factory.

Typical connection

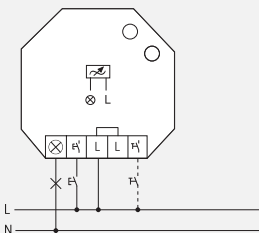

Control by pushbutton switches or light switches.

Universal Dimmer Switch EUD61NPN

EUD61NPN-UC



B12

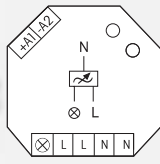

Power MOSFET up to 400W. Energy saving lamps ESL up to 100W and LED up to 100W. Standby loss 0.1 watt only. With adjustable minimum brightness or dimming speed. With switching operation for children's rooms and snooze function.

For installation. 45 mm long, 55 mm wide, 18 mm deep.

Universal dimmer switch for R, L and C loads up to 400 watts, depending on ventilation conditions. Dimmable energy saving lamps ESL up to 100 watts and dimmable 230V LED lamps up to 250 watts. Automatic detection of load R+L or R+C. ESL and LED is manually settable. No minimum load required.

Zero passage switching with soft start and soft OFF to protect lamps.

Universal control voltage 8 to 230V UC, electrically isolated from the 230V supply voltage and switching voltage.

Short-time control commands switch on/off, permanent control varies the brightness up to the maximum level.

An interruption of control changes the direction of dimming.

The brightness level is stored after switching off.

In case of a power failure the switching position and the brightness level are stored.

If applicable the dimmer will be switched on at the stored brightness level after the supply voltage is recovered.

Automatic electronic overload protection and over-temperature switch-off.

With the top rotary switch %E/dim speed can be adjusted either the minimum brightness level (completely dimmed down) or the dim speed.

In operation, **the lower rotary switch** determines the load type to which the dimming curve is set.

Position R, L, C is the setting for all load types except for ESL and LED. In particular for 230V glow and halogen lamps. Automatic detection of load type inductive or capacitive.

The settings +ESL and -ESL consider the special conditions regarding dimmable energy saving lamps: The starting operation is optimized and adapted to the dimming curve. In these settings the special switching operation for children's rooms is not possible and no wound (inductive) transformer must be dimmed. In position -ESL Memory is switched off. This can be of advantage for energy saving lamps because cold energy saving lamps require a higher minimum brightness as it will possibly be stored in Memory for warmer energy saving lamps.

The position LEDs take account of special conditions with dimmable 230V LED lamps:

A number of different dimming curves are available. An updated list with dimming curve assignment for commercially available dimmable 230V LED lamps is ready for downloading at www.eltako.com/dimming_curve/LED_gb.pdf. In these settings no wound (inductive) transformer must be dimmed.

Switching operation for children's rooms: If the light is switched on by holding down the pushbutton, it starts at the lowest brightness level after approx. 1 second and dims up slowly as long as the pushbutton is held down without modifying the last stored brightness level.

Snooze function: With a double impulse the lighting is dimmed down from the current dimming position to the minimum brightness level and switched off. The current dimming position as well as the adjustable minimum brightness level determine the dimming time (max. = 60 minutes) which can be reduced as required. It can be switched off at any time by short-time control commands during the lighting is dimmed down. Holding down the pushbutton during the dimming down process dims up and stops the snooze function.

Mixing of L loads (inductive loads, e.g. wound transformers) and C loads (capacitive loads, e.g. electronic transformers) is not permitted. R loads (ohmic loads, e.g. 230V incandescent lamps and halogen lamps) may be added anytime.

Mixing of L loads and C loads is possible with dimmer switches **EUD12Z** (description page B2) and **EUD12D** (page B3) in connection with capacity enhancer **LUD12** (page B5).

Function rotary switches

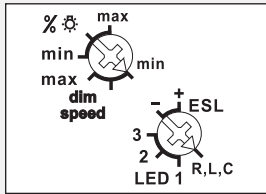

Standard setting ex factory.

Typical connection

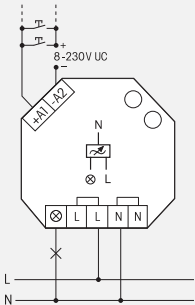

Technical data page B16. Housing for operating instructions GBA12 page Z5.

EUD61NPN-UC

Power MOSFET 400 W

EAN 4010312107874

51,80 €/pc.

Recommended retail prices excluding VAT.

EUD61M-UC

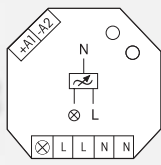

Power MOSFET up to 400W. Energy saving lamps ESL up to 100W. Standby loss 0.1 watt only. With adjustable minimum brightness. With switching operation for children's rooms and snooze function.

Built-in device for installation. 45 mm long, 55 mm wide, 18 mm deep.

Universal dimmer switch for R, L and C loads up to 400 watt, depending on ventilation conditions. Dimmable energy saving lamps ESL up to 100 watt. Automatic detection of load R+L or R+C. ESL is manually settable.

Zero passage switching with soft start and soft OFF to protect lamps.

Universal control voltage input 8 to 230 V UC, electrically isolated from the 230V supply voltage and switching voltage.

Short-time control commands switch on/off, permanent control varies the brightness to the maximum level.

An interruption of control changes the direction of dimming.

The brightness level is stored after switching off in case the **function memory** is set.

If the **function on max** is set, it always switches on at the maximum brightness level.

In case of a power failure the switching position and the brightness level are stored.

If applicable the dimmer will be switched on at the stored brightness level after the supply voltage is recovered.

Automatic electronic overload protection and over-temperature switch-off.

The minimum brightness level (completely dimmed down) can be adjusted with **the upper rotary switch** %⚙️, e.g. for dimmable energy saving lamps.

The lower function rotary switch selects 7 different functions.

Setting of function ESV same as "memory+soft on" with setting of a release delay up to 90 minutes with the rotary switch %⚙️ if the manual off command is not given. Before time-out switch-off early warning function by dimming down within 1 minute.

The settings +ESL and -ESL consider the special conditions regarding dimmable energy saving lamps: The starting operation is optimized and adapted to the dimming curve. In these settings the special switching operation for children's rooms is not possible and no wound (inductive) transformer must be dimmed. In position -ESL Memory is switched off. This can be of advantage for energy saving lamps because cold energy saving lamps require a higher minimum brightness as it will possibly be stored in Memory for warmer energy saving lamps.

Switching operation for children's rooms: If the light is switched on by holding down the pushbutton, it starts at the lowest brightness level after approx. 1 second and dims up slowly as long as the pushbutton is held down without modifying the last stored brightness level.

Snooze function: With a double impulse the lighting is dimmed down from the current dimming position to the minimum brightness level and switched off. The current dimming position as well as the adjustable minimum brightness level determine the dimming time (max. = 60 minutes) which can be reduced as required. It can be switched off at any time by short-time control commands during the lighting is dimmed down. Holding down the push-button during the dimming down process dims up and stops the snooze function.

Mixing of L loads (inductive loads, e.g. wound transformers) and C loads (capacitive loads, e.g. electronic transformers) is not permitted. R loads (ohmic loads, e.g. 230V incandescent lamps and halogen lamps) may be added anytime.

Mixing of L loads and C loads is possible with dimmer switches **EUD12Z** (description page B2) and **EUD12D** (page B3) in connection with capacity enhancer **LUD12** (page B5).

Function rotary switches

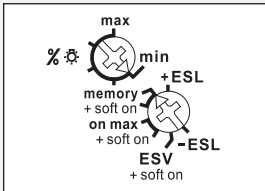

Standard setting ex factory.

Typical connection

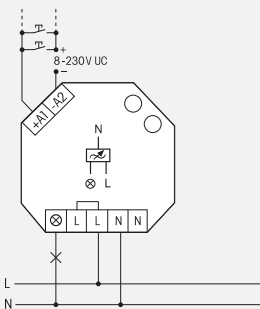

Technical data page B16. Housing for operating instructions GBA12 page Z5.

EUD61M-UC

Power MOSFET up to 400W

EAN 4010312107973

51,80 €/pc.

Recommended retail prices excluding VAT.

LED Dimmer Switch ELD61

NEW

ELD61/12-36V DC



B14

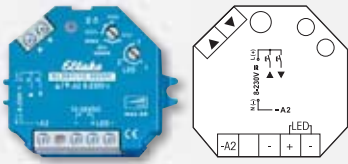

Power MOSFET for LED lamps 12-36V DC up to 4 A, pulse width modulation PWM. Stand-by loss 0.1 Watt only. With adjustable minimum brightness or dimming speed. With switching operation for children's rooms and snooze function.

For installation. 45 mm long, 55 mm wide, 18 mm deep.

Dimmer switch for R- and LED loads up to 4 A depending on ventilation conditions.

Zero passage switching with soft start and soft OFF to protect lamps.

Control voltage input 12 to 36V DC, depending on the connected LED illumination.

A pulse resistant switching power supply unit is necessary.

Universal control voltage 8..230V UC, electrically isolated from the supply voltage.

Either direction pushbuttons can be connected to ▲ ▼ or these terminals will be bridged and a pushbutton will be connected as an universal pushbutton.

With universal pushbutton: short commands switch on/off, permanent control changes the brightness to the maximum. An interruption of the control changes the dimming direction.

With direction pushbutton: switching and dimming on with ▲, turning and dimming off with ▼. A dual pulse with ▲ effects dimming on up to the maximum brightness with the set dimming speed (dimspeed).

The set brightness level will be stored when turning off (Memory).

In case of power failure the switching position and the brightness level will be stored and will be switched on when supply voltage recurs.

Automatic electronic overload protection and overtemperature switch off.

With the top rotary switch % ⚙️/dim speed either the minimum brightness level (completely dimmed down) or the dim speed can be adjusted.

The lower rotary switch determines the load type to which the dimming curve is set: position 1 is the standard setting. With position 2 and 3 it can be varied on request.

With switching operation for children's rooms (universal or direction pushbutton ▲): if the light is switched on by holding down the pushbutton it starts at the lowest brightness level after approx. 1 second and dims up slowly as long as the pushbutton is pressed without modifying the latest stored brightness level.

Snooze function (universal or direction pushbutton ▼): with a double impulse the lighting is dimmed down from the current dimming position to the minimum brightness level and switched off. The current dimming position as well as the adjustable minimum brightness level determine the dimming time (max. = 60 minutes) which can be reduced as required. It can be switched off at any time by short-time control commands during the lighting is dimmed down. Holding down the pushbutton during the dimming down process dims up and stops the snooze function.

Function rotary switches

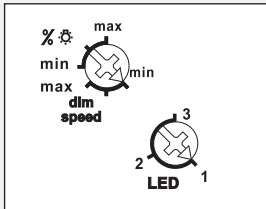

Standard setting ex factory.

Typical connection

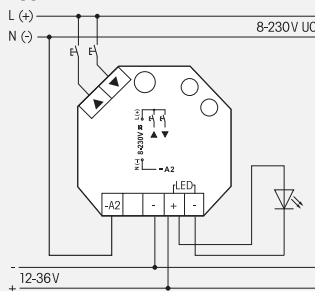

Technical data page B16. Shortstroke pushbuttons page Z1-Z3.

ELD61/12-36 V DC

Power MOSFET up to 4 A

EAN 4010312109502

49,80 €/pc.

Recommended retail prices excluding VAT.

SDS61/1-10V

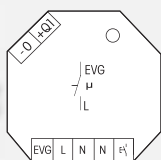
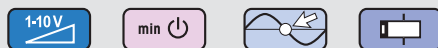

1 NO contact not potential free 600VA and 1-10V control output 40 mA. Only 1 watt standby loss. With adjustable dimming speed. With switching operation for children's rooms and snooze function. With pushbutton or switch activation.

Built-in device for installation. 45 mm long, 55 mm wide, 33 mm deep.

Zero passage switching with soft ON and soft OFF to protect lamps.

Switching voltage and control voltage 230V.

State-of-the-art hybrid technology combines advantages of nonwearing electronic control with high capacity of special relays.

The load is switched on and off by a bistable relay at output EVG (electronic ballast units). Switching capacity for fluorescent lamps or LV halogen lamps with electronic ballast units 600VA.

By using a bistable relay coil power loss and heating is avoided even in the on mode.

After installation, wait for short automatic synchronisation before the switched consumer is connected to the mains.

Short-time control commands switch on/off, permanent control varies the brightness up to the maximum level. An interruption of control changes the direction of dimming.

The brightness level is stored after switching off.

In case of a power failure the switching position and the brightness level are stored.

If applicable the dimmer will be switched on at the stored brightness level after the supply voltage is recovered.

The dimming speed is adjustable **using the dimming speed rotary switch (only for pushbutton activation).**

If light switches cannot be replaced by light pushbuttons, the rotary switch can be set to the switch symbol at the right stop: When the closed switch is briefly opened, the light is dimmed until the switch is briefly opened again. The dimming direction is changed automatically at each of the two vertices. In addition the direction can be changed by opening the switch briefly twice.

Switching operation for children's rooms (only for pushbutton activation): If the light is switched on by holding down the pushbutton, it starts at the lowest brightness level after approx. 1 second and dims up as long as the pushbutton is held down without modifying the last stored brightness level.

Snooze function (only for pushbutton activation): With a double impulse the lighting is dimmed down from the current dimming position to the minimum brightness level and switched off. The current dimming position as well as the adjustable minimum brightness level determine the dimming time (max. = 60 minutes) which can be reduced as required. It can be switched off at any time by short-time control commands during the lighting is dimmed down. Holding down the pushbutton during the dimming down process dims up and stops the snooze function.

Function rotary switches

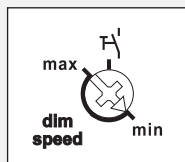

Standard setting ex factory.

Typical connection

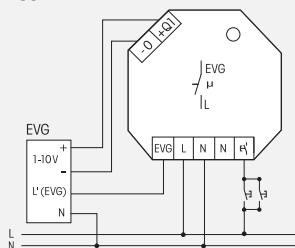

Technical Data Universal Dimmer Switches, Capacity Enhancers and 1-10V Controllers

B16

	ELD61	EUD12NPN ¹⁾ EUD12Z ¹⁾ EUD12D ¹⁾ LUD12 ¹⁾ MFZ12PMD ¹⁾	EUD61NPN ¹⁾ EUD61M ¹⁾ EUD61NP ¹⁾	EUD12F ¹⁾	SDS12 SUD12	SDS61	MOD12D
Spacing of control connections/load	6 mm	6 mm	6 mm EUD61NP: 3 mm	6 mm	6 mm	3 mm	6 mm
Incandescent lamps 230V (R)	–	up to 400 W	up to 400 W	up to 300 W	–	–	–
Halogen lamps 230V (R)	–	up to 400 W	up to 400 W	up to 300 W	–	–	–
Inductive transformers (L)	–	up to 400 W ²⁾³⁾	up to 400 W ²⁾³⁾	up to 300 W ²⁾³⁾	–	–	–
Motor (L)	–	–	–	–	–	–	up to 300W ⁷⁾
Capacitive transformers (C) ⁸⁾	–	up to 400 W ²⁾³⁾	up to 400 W ²⁾³⁾	up to 300 W ²⁾³⁾	–	–	–
Dimmable energy saving lamps ESL ⁵⁾⁶⁾	–	up to 100 W	up to 100 W (not EUD61NP)	up to 100 W	–	–	–
Dimmable 230V LED lamps ⁵⁾⁶⁾	–	up to 100 W (not EUD12Z)	only EUD61NPN: up to 100 W	–	–	–	–
Dimmable LED lamps 12-36V DC	4 A						
1-10V EVG*	–	–	–	–	40 mA 600 VA	40 mA 600 VA	–
Maximum conductor cross-section (3-fold terminal)	4 mm ²	6 mm ² (4 mm ²)	4 mm ²	6 mm ² (4 mm ²)	6 mm ² (4 mm ²)	4 mm ²	6 mm ² (4 mm ²)
Two conductors of same crosssection (3-fold terminal)	1.5 mm ²	2.5 mm ² (1.5 mm ²)	1.5 mm ²	2.5 mm ² (1.5 mm ²)	2.5 mm ² (1.5 mm ²)	1.5 mm ²	2,5 mm ² (1.5 mm ²)
Screw head	slotted/cross-head, pozidriv	slotted/cross-head, pozidriv	slotted/cross-head	slotted/cross-head, pozidriv	slotted/cross-head, pozidriv	slotted/cross-head, pozidriv	slotted/cross-head, pozidriv
Type of enclosure/terminals	IP30/IP20	IP50/IP20	IP30/IP20	IP50/IP20	IP50/IP20	IP30/IP20	IP50/IP20
Time on	100 %	100 %	100 %	100 %	100 %	100 %	100 %
Max./min. temperature at mounting location	+50°C/-20°C ⁴⁾	+50°C/-20°C ⁴⁾	+50°C/-20°C ⁴⁾	+50°C/-20°C ⁴⁾	+50°C/-20°C	+50°C/-20°C ⁴⁾	+50°C/-20°C
Standby loss (active power)	0.1 W	0.1 W EUD12D and MFZ12PMD: 0.3 W	0.1 W EUD61NP: 0.5 W	0.1 W	1 W SUD12: 0.9 W	1 W	0.3 W
Control voltage	8..230V UC	8..230V UC	8..230V UC EUD61NP: 230V	internal DC voltage	8..230V UC	230 V	8..230V UC
Control current 230V-control input	–	–	EUD61NP: 0.7 mA	–	–	0.5 mA	–
Control current universal control voltage all control voltages (< 5 s) 8/12/24/230V (< 5 s)	2/3/7/4(100) mA	10(100) mA	2/3/7/4 (100) mA	– –	3/5/10/4(100) mA	–	2/3/8/5 (100) mA
Control current central 8/12/24/230V (< 5 s)	–	3/5/10/4(100) mA	–	–	3/5/10/4(100) mA	–	2/3/8/5 (100) mA
Max. parallel capacitance (approx. length) of single control lead at 230V AC	0.3 µF (1000m)	0.9 µF (3000 m)	0.9 µF (3000 m) EUD61NP: 0.3 µF (1000 m)	–	0.3 µF (1000 m)	0.06 µF (200 m)	0.9 µF (3000 m)
Max. parallel capacitance (approx. length) of central control lead at 230V AC	–	0.9 µF (3000 m)	–	–	0.3 µF (1000 m)	–	0.9 µF (3000 m)

* EVG = electronic ballast units; KVG = conventional ballast units

¹⁾ At a load of more than 200 W (EUD12F: 100 W) a ventilation clearance of 1/2 module to adjacent devices must be maintained.

The switching capacity of the EUD61 depends also on the ventilation conditions.

²⁾ Per dimmer or capacity enhancer it is only allowed to use max. 2 inductive (wound) transformers of the same type, furthermore no-load operation on the secondary part is not permitted. The dimmer might be destroyed. Therefore do not permit load breaking on the secondary part. Operation in parallel of inductive (wound) and capacitive (electronic) transformers is not permitted!

³⁾ **When calculating the load a loss of 20% for inductive (wound) transformers and a loss of 5% for capacitive (electronic) transformers must be considered in addition to the lamp load.**

⁴⁾ Affects the max. switching capacity.

⁵⁾ In the settings ESL and LED no wound (inductive) transformer must be dimmed.

⁶⁾ Increase of capacity for dimmable energy saving lamps ESL and dimmable 230V LED lamps see page B6.

⁷⁾ Only 1 motor may be connected.

⁸⁾ For 12V halogen and LED lamps.