

Smart Metering

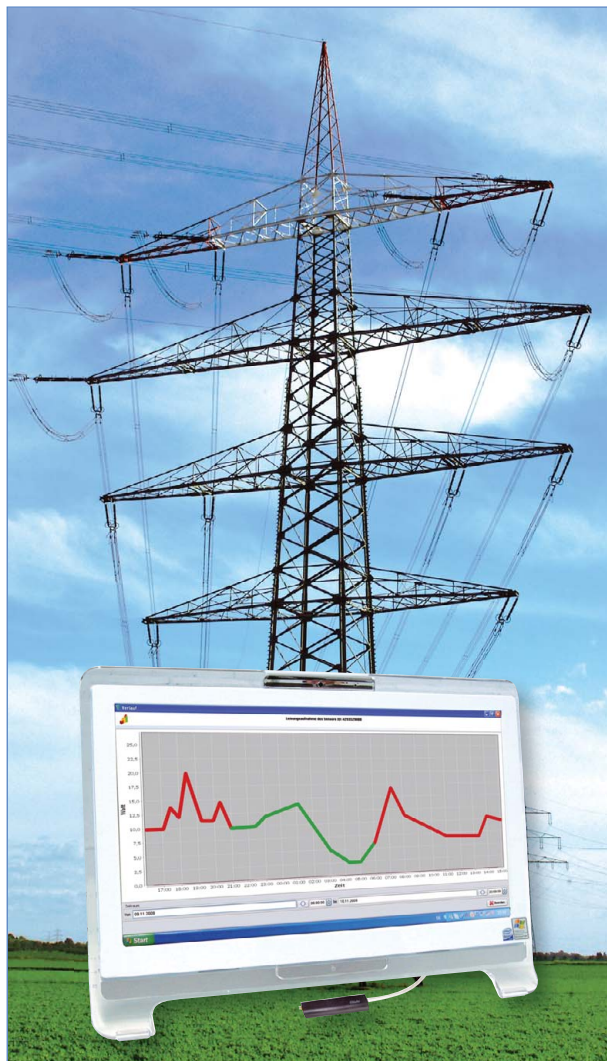

Smart metering with Eltako Wireless Building	2
Wireless energy consumption indicator FEA55LED with LED and FEA55D with display	3
Wireless Visualisation and Control Software FVS-Energy and wireless energy meter transmitter module FSS12	5
Energy consumption indicator EVA12 and wireless single-phase energy meter transmitter module FWZ12 and FWZ61	6
NEW Wireless actuator Impulse switch with integr. relay function with active power measurement FSR70W-16A and with current measurement FSR61VA-10A	8
Selection table single-phase and three-phase energy meters	9
NEW Single-phase energy meter WSZ12D-32A and single-phase energy meter WSZ12D-65A , with MID approval	10
Single-phase energy meter WSZ12DE-32A , without approval	11
Single-phase energy meter WSZ12DE-65A , without approval	11
Single-phase energy meter WZR12 with reset, without approval	12
Three-phase energy meter DSZ12D with display and MID approval	13
Three-phase energy meter DSZ12WD with display and MID approval	13
Three-phase energy meter DSZ12DE with display, without approval	14
Three-phase energy meter DSZ12WDE with display, without approval	14
NEW Electronical single-phase energy meters and three-phase energy meters for meter mounting installation WSZ60 , DSZ60 and DSZ60D	15
Technical data single-phase and three-phase energy meters and energy consumption indicator	16
Measuring Instruments Directive MID	18

Observing power consumption is a recognised way to sharpen awareness about energy consumption and to realise how consumers are driving up costs at what time of the day. If automatic countermeasures are taken – e.g. appliances with high consumption are only switched on at low tariff periods – this knowledge and the corresponding efforts take on a practical ecological and economic purpose.

Eltako Wireless Building offers Smart Metering in several stages. From a low-cost solution in the home up to a professional solution in large buildings for genuine energy management.

Stage 1 in a home

A FWZ single-phase energy meter transmitter module in a circuit measures power consumption and sends wireless telegrams to the Eltako wireless network. We manufacture transmitter modules such as FWZ12 rail mounted devices for central installation up to 16A and 65A, or the FWZ61 build-in device for decentralised installation up to 16A.

An FEA55LED energy consumption indicator receives these wireless telegrams and displays realtime consumption and normal rate / off-peak by LEDs.



Stage 2 in a home

Consumption measurement as for Stage 1. A FEA55D digital energy consumption indicator with display and a memory for consumption parameters receives the wireless telegrams. Realtime consumption and accumulated consumption are displayed constantly. The consumption over the past hours, days, months and years is also retrievable.



Stage 3 in a home or a building

Power consumption is queried directly from the energy meters via their SO interfaces and sent over the Eltako wireless network by an FSS12 energy meter transmitter module. An integrated load shedding relay can switch off consumers if a preset consumption is exceeded.

Energy consumption in Stages 1 and 2 can be indicated by a FEA55 or by means of the FVS-Energy FVS Wireless Visualisation and Control Software or the FVS of the FVS-Safe. FVS-Energy is downloadable free of charge from the Eltako website.



Stage 4 in all residential, office and commercial buildings

Up to 30 energy meters in a group can be connected by their SO interfaces to the FPZ12 wireless Powernet meter connector. Up to 3 meters per FPZ12. These FPZ12s transmit meter information over the power mains (Powernet). This information can be read out with other FPZ12s at any point in the internal building power mains and either transmitted over the Eltako wireless network or directly sent via an USB connection to FVS-Safe.

The data is displayed, evaluated and stored using the FVS Wireless Visualisation and Control Software of the FVS-Safe server. This can also be performed by FEA55 energy consumption displays in individual homes, departments or machine locations.

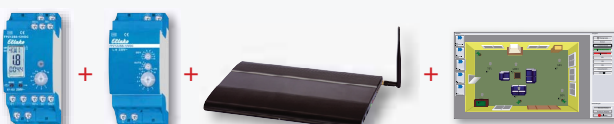

Smart Metering is so cost-effective and incurs no follow-on costs:

The energy consumption indicator EVA12 (page 6) displays the current active current consumption in the control cabinet or distributor. They save the consumption figures in non-volatile memories that are viewable at any time. The wireless energy consumption Indicators FEA55LED and FEA55D (page 4) show directly the wireless readings of an energy meter transmitter module FSS12 (page 5), FWZ12 (page 7), FWZ61 (page 7) or of a wireless impulse switch with integrated relay function with active current meter FSR70W-16A respectively with power measurement FSR61VA-10A. The energy consumption indicator with display FEA55D saves the values in the same way as the EVA12.

Only the Wireless Visualisation and Control Software FVS on your PC can evaluate several meters. FVS Energy and FVS Home can evaluate up to 100 meters and FVS Professional up to 250 meters.

FEA55LED-



Wireless energy consumption indicator with 10 red LEDs for individual fitting and integration in the 55x55 mm and 63x63 mm switch system. Standby loss 0.8 watt only.

The scope of supply includes a frame R, an intermediate frame ZR in the same colour, a mounting plate and an adhesive film. In addition, an intermediate frame ZRF in the same colour is supplied for installation in an existing frame R1F, R2F or R3F for flat pushbuttons. Power supply 230 V.

A 20cm long black/blue connecting wire is routed to the rear.

Before screwing on, remove the frame and intermediate frame from the mounting plate. To do this, press out the catches on the mounting plate. Then screw on the mounting plate - with the catches at the top and bottom -, snap on the frame and the intermediate frame, and connect and snap on the energy consumption indicator.

We recommend sheet metal countersink screws 2.9x25 mm, DIN 7982 C, for screw connections on 55mm switch boxes.

The energy consumption indicator evaluates the information received from the wireless energy meter transmitter module FSS12 or the wireless single-phase energy meters FWZ12- or FWZ61-16A or from a wireless impulse switch with integrated relay function with active current meter FSR70W-16A respectively with power measurement FSR61VA-10A and indicates the current energy consumption by a row of LEDs.

The normal rate and off-peak status are also displayed by the FSS12.

The 15W to 30kW reading is adaptable to maximum expected consumption using a rotary switch to visualise even minor changes. There are 5 ranges to choose from, starting on the left with 1, 3, 7, 15 and 30kW. On the energy consumption indicator, a maximum of 5 out of 10 LEDs light up simultaneously, and the last clockwise LED lights up the brightest. If one range setting is exceeded, the last LED flashes.

A light sensor controls LED brightness depending on the ambient brightness.

* The bottom of the housing is matt.

FEA55LED-ws	Energy consumption indicator with LED white	EAN 4010312302750	74,90 €/pc.
FEA55LED-rw	Energy consumption indicator with LED pure white	EAN 4010312302774	74,90 €/pc.
FEA55LED-sz	Energy consumption indicator with LED black	EAN 4010312302798	74,90 €/pc.
FEA55LED-an	Energy consumption indicator with LED anthracite	EAN 4010312302828	74,90 €/pc.
FEA55LED-wg*	Energy consumption indicator with LED pure white glossy	EAN 4010312302804	74,90 €/pc.
FEA55LED-si*	Energy consumption indicator with LED silver grey glossy	EAN 4010312304631	74,90 €/pc.
FEA55LED-al	Energy consumption indicator with LED coated/aluminium paint	EAN 4010312310779	83,70 €/pc.
FEA55LED-sg*	Energy consumption indicator with LED black glossy	EAN 4010312310786	83,70 €/pc.

Recommended retail prices excluding VAT.

Direct display with the Wireless Energy Consumption Indicator FEA55D

FEA55D-



Wireless energy consumption indicator with display for individual fitting and integration in the 55x55 mm and 63x63 mm switch system. Standby loss 0.8 watt only.

The scope of supply includes a frame R, an intermediate frame ZR in the same colour, a mounting plate and an adhesive film. In addition, an intermediate frame ZRF in the same colour is supplied for installation in an existing frame R1F, R2F or R3F for flat pushbuttons. Power supply 230 V.

A 20cm long black/blue connecting wire is routed to the rear.

Before screwing on, remove the frame and intermediate frame from the mounting plate. To do this, press out the catches on the mounting plate. Then screw on the mounting plate - with the catches at the top and bottom -, snap on the frame and the intermediate frame, and connect and snap on the energy consumption indicator.

We recommend sheet metal countersink screws 2.9x25mm, DIN 7982 C, for screw connections on 55mm switch boxes.

The energy consumption indicator evaluates the information received from the wireless energy meter transmitter module FSS12 or the wireless single-phase energy meters FWZ12 or FWZ61 and indicates alternately at a rate of 4 seconds the aggregate power consumption and the momentary power consumption (P at the end of the display) from 15W to 65kW. In addition, press the MOD and SEL buttons to call up consumption values in the last hours, days, months and years.

The normal rate and off-peak status are also displayed on the FSS12 by an LED.

Display readings

The standard display appears after power is applied.

The power consumption is displayed alternating for a duration of 4 seconds. The reading, comprising 7 digits of which there is one decimal place, ranges from 0.1 to 999999.9kWh or the actual value of the power consumption from 15P to 65000P (active power) in watts (W).

Press the top button MOD to page through the display options. They are indicated by a bar: h (hours), d (days), m (months), y (years), LRN.

Press the bottom button SEL within the display options. Each press of the button increments the number displayed by 1 and the actual value is indicated in the display. The last full hour then becomes the last hour but one, etc.

h01 = shows the consumption for the last hour up to h24 = 24 hours ago.

d01 = shows the consumption for the last day up to d31 = 31 days ago.

m01 = shows the consumption for the last month up to m12 = 12 months ago.

y01 = shows the consumption for the last year up to y24 = 24 years ago.

The program returns to the standard display mode automatically if MOD or SEL are not operated for 20 seconds or if you press both buttons briefly simultaneously.

* The bottom of the housing is matt.

FEA55D-ws	Energy consumption indicator with display white	EAN 4010312302675	60,90 €/pc.
FEA55D-rw	Energy consumption indicator with display pure white	EAN 4010312302699	60,90 €/pc.
FEA55D-sz	Energy consumption indicator with display black	EAN 4010312302712	60,90 €/pc.
FEA55D-an	Energy consumption indicator with display anthracite	EAN 4010312302743	60,90 €/pc.
FEA55D-wg*	Energy consumption indicator with display pure white glossy	EAN 4010312302729	60,90 €/pc.
FEA55D-si*	Energy consumption indicator with display silver grey glossy	EAN 4010312304648	60,90 €/pc.
FEA55D-al	Energy consumption indicator with display coated/aluminium paint	EAN 4010312310809	69,70 €/pc.
FEA55D-sg*	Energy consumption indicator with display black glossy	EAN 4010312310793	69,70 €/pc.

Recommended retail prices excluding VAT.

Radio telegrams from the wireless energy meter transmitter module FSS12 and the self-learning wireless single-phase energy meter transmitter modules FWZ12 and FWZ61 can be received and displayed on a PC using the **Wireless Visualisation and Control Software FVS-Energy** and the USB receiver FAM-USB.

⚠ Caution! The FVS-Energy software is contained in the Wireless Visualisation Software FVS-Home and FVS-Professional and need not be installed separately.

FVS-Energy

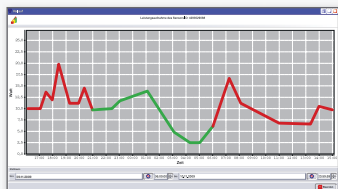

Free-of-charge wireless visualisation and control software for up to 100 energy meters with energy meter transmitter module FSS12.

The software is ready for downloading at "eltako-wireless.com". Updates will also be available there free of charge.

The wireless receiver FAM-USB with USB port is also required for PC reception and if required for transmitting wireless telegrams from a PC to load shedding relays in addition. A web license is necessary.

FSS12-12 V DC

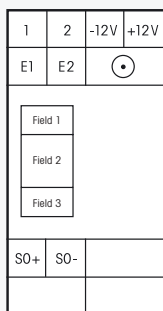

Wireless Energy meter transmitter module for connection to SO interface of the Eltako single-phase energy meter and three-phase energy meter. Only 0.5 watt standby loss. With load shedding relay 1 NO contact potential free 4A/250V and with exchangeable antenna. If required, a wireless antenna FA250 can be connected.

Modular device for DIN-EN 60715 TH35 rail mounting. 2 modules = 36mm wide, 58mm deep. The energy meter transmitter module FSS12 evaluates the signals from the energy meter SO interface and transmits wireless telegrams containing consumption and meter reading to the Eltako wireless network for evaluation on a PC using the Visualisation and Control Software FVS Home and FVS Energy. On three-phase energy meters, the data sent includes normal rate (HT) or off-peak (NT) energy tariff data, provided the E1/E2 terminals on the three-phase energy meter are connected to E1/E2 on the FSS12.

The enclosed small antenna can be replaced with a wireless antenna FA250 or FA200 with magnetic base and cable.

Typical connection

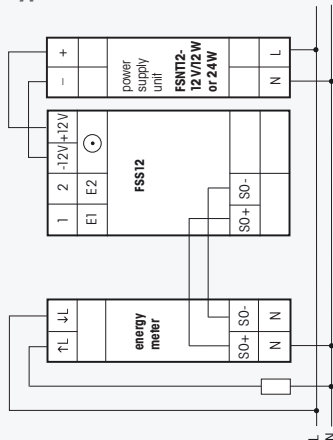

FVS-Energy and FVS-Home support up to 100 transmitter modules and FVS-Professional up to 250 transmitter modules.

The 12V DC supply voltage of the complete RS485 bus is mainly powered at 12W or 24W by a switch mode power supply unit FSNT12-12V DC that is only 1 or 2 pitch units wide. When the relay of the FSS12 is switched on, a power of 0.6 watts is required.

The setting and display screen is subdivided into 3 fields:

- **Field 1:** The normal display is the unit of the meter reading currently displayed in Field 3. This alternates every 4 seconds with either kilowatt hours kWh (KWH in display) or megawatt hours MWh (MWH in display). The display in Field 1 is supplemented by a + sign after the reading to indicate that the off-peak tariff rate is applied to E1/E2.
- **Field 2:** Instantaneous values of energy consumption (active power) in watt (W) or kilowatt (kW). The left-pointing arrow in Field 1 indicates an automatic switchover from 0 to 99W to 0.1 to 65kW.
- **Field 3:** The meter reading is the normal display. Every 4 seconds the display alternates between 3 whole numbers and 1 decimal point (from 0.1 to 999.9kWh) and 1 or max 3 whole numbers (from 0 to 999MWh).

Wireless telegrams: A power telegram is transmitted every 130 seconds and the display is updated. Otherwise a telegram is transmitted within 20 seconds if the power changes by minimum 10 percent. A switchover from HT to NT is transmitted immediately in the same way as a meter reading change. A full telegram comprising meter reading HT, meter reading NT and power is transmitted 20 seconds after the power supply is switched on and then every 10 minutes. The LED lights up briefly when a telegram is transmitted.

See page 2-3 of the 'The Eltako Wireless Building' Catalogue for a detailed description.

FAM-USB with license FVS-Energy	USB wireless receiver	EAN 4010312305003	149,60 €/pc.
FSS12-12V DC	Wireless energy meter transmitter module	EAN 4010312301944	79,80 €/pc.

Recommended retail prices excluding VAT.

EVA12-32 A

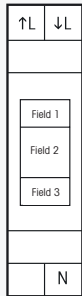

Maximum current 32A, standby loss 0.5 watt only.

Modular device for DIN-EN 60715 TH35 rail mounting.

1 module = 18mm wide, 58mm deep.

The energy consumption indicator EVA12 uses the current between input and output to measure active energy in the same way as a single-phase energy meter. It saves the consumption parameter in a non-volatile memory.

Accuracy conforms to Class B MID (1%) like all Eltako single-phase energy meters. The inrush current is 20mA.

In this way the energy consumption indicator reproduces exactly the reading on the billing energy meter installed at a different location in the building.

The display is subdivided into 3 fields.

Typical connection

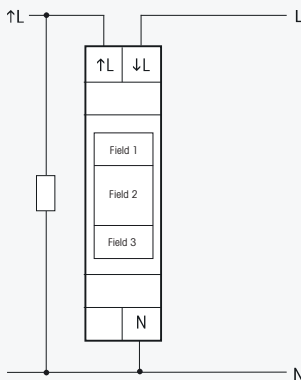

Field 1:

This display refers to the cumulative value in field 3.

|||| moving slowly to the right = Field 3 shows the cumulative consumption since last reset. This is the display standard mode.

H01 = Field 3 shows the consumption for the last hour up to H24 = 24 hours ago.

D01 = Field 3 shows the consumption for the last day up to D31 = 31 days ago.

M01 = Field 3 shows the consumption for the last month up to M12 = 12 months ago.

Y01 = Field 3 shows the consumption for the last year up to Y24 = 24 years ago.

Field 2:

Instantaneous values of energy consumption (active power) in watt (W) or kilowatt (kW). The display arrows on the left and right show the automatic change W and kW.

Field 3:

Cumulative value in kWh. Display up to 9.999kWh with 3 decimal digits, from 10kWh with 1 decimal digit and from 1000kWh without decimal digit.

Press the left button MODE to scroll down the display options which are shown in field 1: H01, D01, M01 and Y01 as described above. Finally, press MODE to show the abbreviation of the set language, e.g. GB for English, D for German and F for French.

Press the right button SELECT once within the display options to increment the indicated figure by 1. The corresponding value is indicated in field 3. The last clock hour then becomes the hour before last, etc.

If the active language was selected with MODE, press SELECT to switch to a different language. Exit the new language setting by pressing MODE to activate the setting. The program returns to the standard display mode automatically if MODE or SELECT are not operated for 20 seconds or if you press both buttons briefly simultaneously.

Reset

To start saving the values to the nearest hour, we recommend performing a reset at an opportune moment after installation. Hold down the buttons MODE and SELECT simultaneously for a further 3 seconds until RES appears in field 1. Then press SELECT briefly to reset all memories. Afterwards the program returns automatically to standard display mode.

FWZ12-16 A

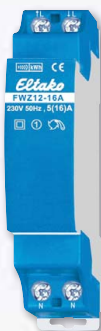

Wireless single-phase energy meter transmitter module, maximum current 16 A. Only 0.5 watt standby loss.

Modular device for DIN-EN 60715 TH35 rail mounting.
1 module = 18mm wide, 58mm deep.

This single-phase energy meter measures active energy by means of the current between input and output and transmits the consumption and meter reading over the Eltako wireless network. Accuracy class B (1%).

Evaluation on PC using the Visualisation and Control Software FVS or the energy consumption indicators FEA55LED or FEA55D. FVS-Energy and FVS-Home support up to 100 transmitter modules, FVS-Professional up to 250 transmitter modules.

The internal power consumption of max. 0.5 watt active power is neither metered nor indicated. Like all meters without PTB or MID approval in Germany, not approved to levy electricity charges. 1 phase conductor with a max. current up to 16A can be connected. The inrush current is 20mA. The consumption is saved to a non-volatile memory and is immediately available again after a power failure.

Wireless telegrams: A telegram is transmitted within 20 seconds if the power status changes by min. 10 percent. A change in meter reading is transmitted immediately. A full telegram comprising meter reading and power status is transmitted every 10 minutes.

When the power supply is switched on, a **teach-in telegram** is sent to teach in the associated energy consumption indicator.

If the L input and the L output were interchanged when hooked up, a normal rate (HT)/off-peak (NT) switchover telegram is transmitted to indicate the hook-up error.

FWZ12-16A

Wireless single-phase energy meter transmitter module 16A

EAN 4010312303184

74,80 €/pc.

FWZ12-65 A

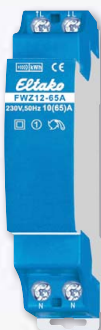

Wireless single-phase energy meter transmitter module, maximum current 65 A. Only 0.5 watt standby loss.

Modular device for DIN-EN 60715 TH35 rail mounting.
1 module = 18mm wide, 58mm deep.

Internal power consumption max. 0.5 watt active power.

1 phase conductor with a max. current up to 65A can be connected. The inrush current is 40mA.

Functions same as FWZ12-16A.

FWZ12-65A

Wireless single-phase energy meter transmitter module 65A

EAN 4010312311059

80,80 €/pc.

FWZ61-16 A

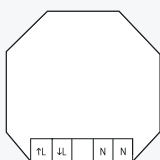

Wireless single-phase energy meter transmitter module, maximum current 16 A. Only 0.5 watt standby loss.

For installation. 45mm long, 55mm wide, 35mm deep.

Internal power consumption max. 0.5 watt active power.

1 phase conductor with a max. current up to 16A can be connected. The inrush current is 20mA. Functions same as FWZ12-16A.

FWZ61-16A

Wireless single-phase energy meter transmitter module

EAN 4010312302354

71,80 €/pc.

Wireless Actuator – Impulse Switch with integr. relay function FSR70W and FSR61VA

8

NEW

FSR70W-16 A

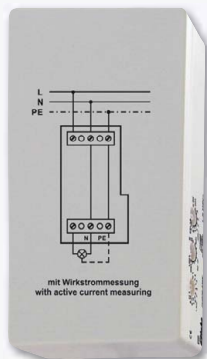

1 NO contact not potential free 16 A/250V AC, incandescent lamps up to 2000 watts. With integrated active power measurement up to 3680 watts. Bidirectional wireless and with repeater function. Only 0.9 watt standby loss.

Mounting in the 230V power supply cord, e.g. in false ceilings.
100mm long, 50mm wide and 31 mm deep.

The integrated **active power measurement** measures power upwards of approx. 10W when the contact is closed and transmits it to the Eltako wireless network. Signal evaluated by the FVS Wireless Visualisation and Control Software or the power consumption displays FEA55.

With **bidirectional wireless**; in addition, a **repeater** function can be switched in. Every change in state and incoming central command telegrams are confirmed by a wireless telegram. This wireless telegram can be taught-in in other actuators, in the FVS software and in FUA55 universal displays.

Function rotary switches
on the side

FSR70W-16A

Wireless actuator – Impulse switch with integr. relay function with active power measurement

EAN 4010312312179

95,90 €/pc.

NEW

FSR61VA-10 A

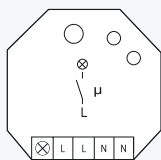

1 NO contact not potential free 10A/250V AC, incandescent lamps up to 2000 watts, off delay with switch-off early warning and switchable push-button permanent light. With integrated current measurement up to 10A. Bidirectional wireless and with repeater function. Only 0.7 watt standby loss.

For installation. 45 mm long, 55 mm wide, 33 mm deep.

Supply voltage 230 V.

The apparent power from approx. 10VA up to 2300VA will be measured at closed contacts with the integrated power measurement and transmitted into the Eltako wireless system. Signal evaluated by the FVS Wireless Visualisation and Control Software or the power consumption displays FEA55.

With **bidirectional wireless**; in addition, a **repeater** function can be switched in. Every change in state and incoming central command telegrams are confirmed by a wireless telegram. This wireless telegram can be taught-in in other actuators, in the FVS software and in FUA55 universal displays.

Scene control: several FSR61s can be switched on or off in a scene by one of the four control signals of a double-rocker pushbutton taught-in as scene pushbutton.

Typical connection

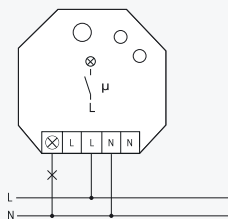

FSR61VA-10 A

Wireless actuator – Impulse switch with integr. relay function with current measurement

EAN 4010312311462

73,70 €/pc.

Recommended retail prices excluding VAT.

The smart counting champions

Eltako offers a complete range of energy meters for DIN-EN 60715 TH35 rail mounting from 32A up to 65A. Special attention should be paid to the power consumption of only 0.3W active power of the 32A and 65A single-phase devices.

If energy meters for DIN-EN 60715 TH35 rail mounting are not used for billing we recommend the "Economy Line" without approval. Our marking is an "E" in the type designation: WSZ12DE-32A, WSZ12E-65A, DSZ12DE-3x65A and DSZ12WDE-3x5A.

All meters have an SO interface according to DIN 43 864.

Page	10 top	10 bottom	11 top	11 bottom	12	13 top	13 bottom	14 top	14 bottom	15 top	15 center	15 bottom
	WSZ12D-32A	WSZ12D-65A	Economy Line WSZ12DE-32A	Economy Line WSZ12DE-65A	WZR12-32A	DSZ12D-3x65A	DSZ12WD-3x5A	Economy Line DSZ12DE-3x65A	Economy Line DSZ12WDE-3x5A	WSZ60	DSZ60	DSZ60D
Modular device for mounting on DIN rail EN 60715 TH35, number of modules 18 mm each	1	1	1	1	1	4	4	4	4	-	-	-
Meter mounting installation										■	■	■
Single-phase energy meter	■	■	■	■	■					■		
Three-phase energy meter						■	■	■	■		■	■
With MID approval	■	■	-	-	-	■	■	-	-	■	■	■
Reference current I_{ref} (Limiting current I_{max}) A	5 (32)	10 (65)	5 (32)	10 (65)	5 (32)	10 (65)	5 (6) ¹⁾	10 (65)	5 (6) ¹⁾	5 (60)	5 (60)	5 (60)
Display drum type register digits										6+1	6+1	
Display LC display digits	5+2 ²⁾ 6+1	5+2 ²⁾ 6+1	5+2 ²⁾ 6+1	5+2 ²⁾ 6+1	2/4	5+2 ²⁾ 6+1	5+2 ²⁾ 6+1	5+2 ²⁾ 6+1	5+2 ²⁾ 6+1			6+1
Accuracy class MID, inaccuracy $\pm 1\%$	B	B	B	B	B	B	B	B	B	B	B	B
With return stop	■	■	■	■	■	■	■	■	■	■	■	■
Display instantaneous values	■	■	■	■	■	■	■	■	■			
Indication of misconnection	■	■	■	■	■	■	■	■	■			
Low standby loss	■	■	■	■	■	■	■	■	■			
SO interface potential free	■	■	■	■		■	■	■	■			

¹⁾ CT operated energy meter

²⁾ Switches over automatically from 5+2 to 6+1.

Single-phase Energy Meters WSZ12D with MID approval

10

NEW

WSZ12D-32A



MID



Maximum current 32A. Standby loss 0.7 watt only.

Modular device for DIN-EN 60715 TH35 rail mounting.

1 module = 18 mm wide and 58 mm deep.

Accuracy class B (1%). With S0 interface.

This single-phase energy meter measures active energy by means of the current between input and output. The internal power consumption of 0.7 watt active power is neither metered nor indicated.

1 phase conductor with a max. current of up to 32A can be connected.

The start current is 20mA.

Zwei N-Klemmen für die sichere Querverdrahtung mehrerer Zähler.

The 7 segment LC display is also legible twice within a period of 2 weeks without power supply. Press the button.

Below the displays is a button which you can use to browse through the menu as described in the User Manual. First the **backlighting** switches on. Then you can display the total active energy, active energy of the resettable memory and the instantaneous values for active power, voltage and current.

Power consumption is shown by a bar flashing at a rate of 1000 times per kWh.

Error message

In the event of a connection error the bar flashes at a high rate (2 times per second).

Typical connection

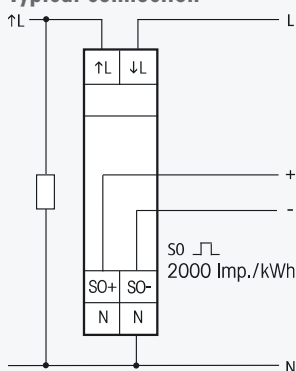

Technical data page 16.

WSZ12D-32A

MID approval

EAN 4010312501269

129,00 €/pc.

NEW

WSZ12D-65A



MID



Maximum current 65A. Standby loss 0.7 watt only.

Modular device for DIN-EN 60715 TH35 rail mounting.

1 module = 18 mm wide and 58 mm deep.

Accuracy class B (1%). With S0 interface.

This single-phase energy meter measures active energy by means of the current between input and output. The internal power consumption of 0.7 watt active power is neither metered nor indicated.

1 phase conductor with a max. current up to 65A can be connected.

The start current is 40mA.

Two N terminals for secure cross wiring of several counters.

The 7 segment LC display is also legible twice within a period of 2 weeks without power supply. Press the button.

Below the displays is a button which you can use to browse through the menu as described in the User Manual. First the **backlighting** switches on. Then you can display the total active energy, active energy of the resettable memory and the instantaneous values for active power, voltage and current.

Power consumption is shown by a bar flashing at a rate of 1000 times per kWh.

Error message

In the event of a connection error the bar flashes at a high rate (2 times per second).

Typical connection

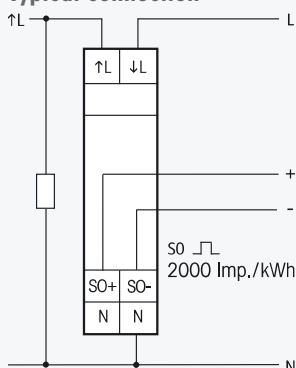

Technical data page 16.

WSZ12D-65A

MID approval

EAN 4010312501283

140,00 €/pc.

Recommended retail prices excluding VAT.

WSZ12DE-32A



Maximum current 32A. Standby loss 0.5 watt only.

Modular device for DIN-EN 60715 TH35 rail mounting. 1 module = 18mm wide and 58mm deep. Accuracy class B (1%). With SO interface.

It measures active energy by means of the current between input and output. The internal power consumption of 0.5 watt active power is neither metered nor indicated. Like all meters without approval (e.g. MID), this meter is not permitted for billing.

Every 30 seconds, the display switches for 5 seconds from the accumulated active energy in kWh to the momentary consumption in watts.

1 phase conductor with a max. current up to 32A can be connected. The inrush current is 20mA. The display can only be read when the power supply is on. However, the consumption is saved to a non-volatile memory and is displayed immediately after power restoration. Two N terminals for secure cross wiring of several counters.

The flashing decimal point is dependent on power consumption and indicates that power is being consumed. If the connection is incorrectly wired, the display shows the message 'false'.

The digital display has 7 digits. Two decimal places are indicated up to 99999.99 kWh. Above 100000.0 kWh there is only one decimal place. Assuming the maximum theoretical power consumption, the display would have a service life of more than 15 years.

The power consumption is displayed with a decimal point.

Typical connection

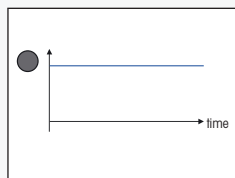
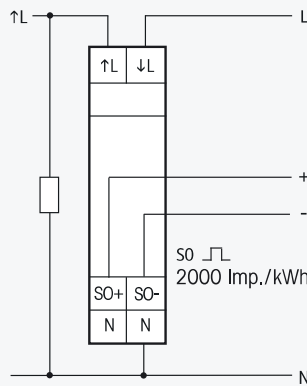

Energy meter connected, no power consumption

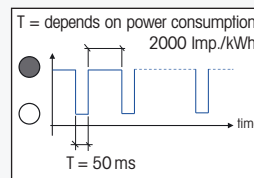

Energy meter correctly connected, with power consumption

Technical data page 16.

WSZ12DE-32A

without approval

EAN 4010312501245

56,00 €/pc.

WSZ12DE-65A

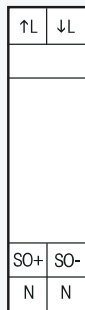

Maximum current 65A. Standby loss 0.5 watt only.

Modular device for DIN-EN 60715 TH35 rail mounting.

1 module = 18mm wide and 58mm deep.

Accuracy class B (1%). With SO interface.

This single-phase energy meter measures active energy by means of the current between input and output. The internal power consumption of 0.5 watt active power is neither metered nor indicated. Like all meters without approval (e.g. MID), this meter is not permitted for billing.

Every 30 seconds, the display switches for 5 seconds from the accumulated active energy in kWh to the momentary consumption in watts.

1 phase conductor with a max. current up to 65A can be connected. The inrush current is 40mA. The display can only be read when the power supply is on. However, the consumption is saved to a non-volatile memory and is displayed immediately after power restoration. Two N terminals for secure cross wiring of several counters.

The power consumption is displayed with a decimal point.

Typical connection

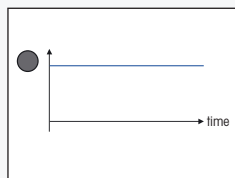
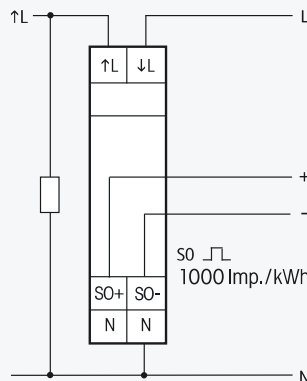

Energy meter connected, no power consumption

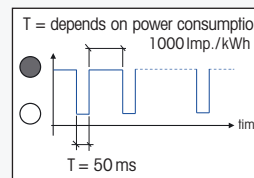

Energy meter correctly connected, with power consumption

without approval

EAN 4010312501276

76,20 €/pc.

Single-phase Energy Meter WZR12 with reset, without approval

12

WZR12-32 A

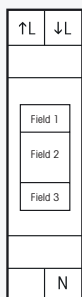

Maximum current 32A, standby loss 0.5 watt only.

Modular device for DIN-EN 60715 TH35 rail mounting.
1 module = 18mm wide, 58mm deep.

This single-phase energy meter with reset function uses the current between input and output to measure active energy and saves the consumption parameter in a non-volatile memory.

Accuracy conforms to Class B MID (1%) like all Eltako single-phase energy meters, the inrush current is 20mA.

The display is subdivided into 3 fields.

■ Field 1:

This display refers to the cumulative value in field 3.

|||| moving slowly to the right = Field 3 shows the cumulative consumption since last reset. This is the display standard mode.

H01 = Field 3 shows the consumption for the last hour up to H24 = 24 hours ago.

D01 = Field 3 shows the consumption for the last day up to D95 = 95 days ago.

■ Field 2:

Instantaneous values of energy consumption (active power) in watt (W) or kilowatt (kW). The display arrows on the left and right show the automatic change W and kW.

■ Field 3:

Cumulative value in kWh. Display up to 9.999kWh with 3 decimal digits, from 10kWh with 1 decimal digit and from 1000kWh without decimal digit.

Press the left button MODE to scroll down the display options which are shown in field 1: H01 and D01 as described above. Finally, press MODE to show the abbreviation of the set language, e.g. GB for English, D for German, F for French and ES for Spanish.

Press the right button SELECT once within the display options to increment the indicated figure by 1. The corresponding value is indicated in field 3. The last clock hour then becomes the hour before last, etc.

If the active language was selected with MODE, press SELECT to switch to a different language. Exit the new language setting by pressing MODE to activate the setting.

The program returns to the standard display mode automatically if MODE or SELECT are not operated for 20 seconds or if you press both buttons briefly simultaneously.

Reset

Hold down the buttons MODE and SELECT simultaneously for 3 seconds until RES appears in segment 1. Then press SELECT briefly to reset all memories. Afterwards the program returns automatically to standard display mode.

Typical connection

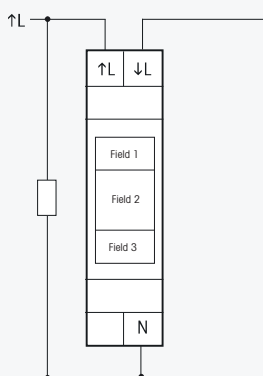

Technical data page 16.

WZR12-32A

Maximum current 32A

EAN 4010312501252

48,60 €/pc.

Recommended retail prices excluding VAT.

DSZ12D-3x65 A



Typical connection
4-wire-connection 3x230/400V

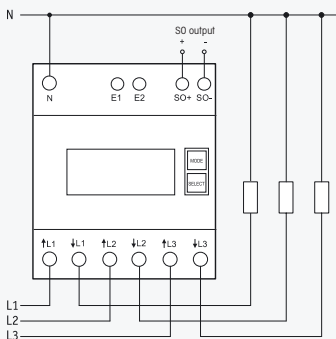

Maximum current 3x65A. Standby loss 0.4 watt per path only.

Modular device for DIN-EN 60715 TH35 rail mounting.
4 modules = 70mm wide and 58mm deep.
Accuracy class B (1%). With S0 interface.

It measures active energy by means of the current between input and output. The internal power consumption of 0.4 watt active power per path is neither metered nor indicated.
1, 2 or 3 phase conductors with max. currents up to 65A can be connected.
The inrush current is 40mA.

The N terminal must always be connected.

The 7 segment LC display is also legible twice within a period of 2 weeks without power supply.

Power consumption is shown by a bar flashing at a rate of 100 times per kWh.

Designed as standard for using as double-tariff meter: Switch over to a second tariff by applying 230V to terminals E1/E2.

On the right next to the display are the keys MODE and SELECT. Press them to scroll through the menu according to the operation manual. First the **background lighting** switches on. The display then shows the total active energy per tariff, the active energy per resettable memory RS1 or RS2, and the instantaneous values of consumption, voltage and current per phase.

Error message (false)

When the phase conductor is missing or the current direction is wrong 'false' and the corresponding phase conductor are indicated on the display.

Technical data page 16.

DSZ12D-3x65A

MID approval

EAN 4010312501207

239,00 €/pc.

DSZ12WD-3x5 A



Typical connection
4-wire-connection 3x230/400V

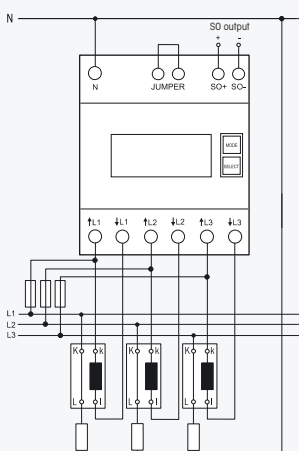

CT operated energy meter with settable CT ratio and MID.

Maximum current 3x5A. Standby loss 0.4 watt per path only.

Modular device for DIN-EN 60715 TH35 rail mounting.
4 modules = 70mm wide and 58mm deep.
Accuracy class B (1%). With S0 interface.

This three-phase energy meter measures active energy by means of the current between input and output. The internal power consumption of 0.4 watt active power per path is neither metered nor indicated.

1, 2 or 3 phase conductors with max. currents up to 5A can be connected.

The inrush current is 10mA.

The N terminal must always be connected.

The 7 segment LC display is also legible twice within a period of 2 weeks without power supply.

Power consumption is shown by a bar flashing at a rate of 10 times per kWh.

On the right next to the display are the keys MODE and SELECT. Press them to scroll through the menu according to the operation manual. First the **background lighting** switches on. The display then shows the total active energy, the active energy per resettable memory, and the instantaneous values of consumption, voltage and current per phase.

The CT ratio can also be set. It is set to 5:5 at the factory and blocked with a bridge over the terminals which are marked with 'JUMPER'. To adjust the CT ratio to the installed transformer remove the bridge and reset the energy meter according to the operation manual. Then block it again with the bridge. Adjustable current transformer ratios: 5:5, 50:5, 100:5, 150:5, 200:5, 250:5, 300:5, 400:5, 500:5, 600:5, 750:5, 1000:5, 1250:5 and 1500:5.

Error message (false)

When the phase conductor is missing or the current direction is wrong 'false' and the corresponding phase conductor are indicated on the display.

Important! Before working on the current transformers disconnect the voltage paths of the energy meters.

Technical data page 16.

DSZ12WD-3x5A

MID approval

EAN 4010312501214

259,00 €/pc.

Three-phase Energy Meters DSZ12 with display, without approval

14

DSZ12DE-3x65 A



Typical connection

4-wire-connection 3x230/400V

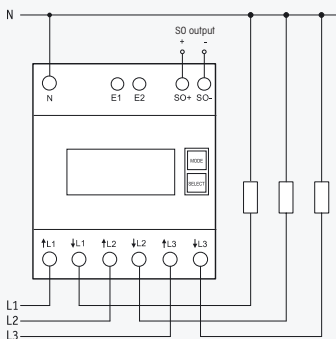

Maximum current 3x65A. Standby loss 0.4 watt per path only.

Modular device for DIN-EN 60715 TH35 rail mounting.

4 modules = 70mm wide and 58mm deep.

Accuracy class B (1%). With S0 interface.

It measures active energy by means of the current between input and output. The internal power consumption of 0.4 watt active power per path is neither metered nor indicated.

1, 2 or 3 phase conductors with max. currents up to 65A can be connected.

The inrush current is 40mA.

The N terminal must always be connected.

The 7 segment LC display is also legible twice within a period of 2 weeks without power supply.

Power consumption is shown by a bar flashing at a rate of 100 times per kWh.

Designed as standard for using as double-tariff meter: Switch over to a second tariff by applying 230V to terminals E1/E2.

On the right next to the display are the keys MODE and SELECT. Press them to scroll through the menu according to the operation manual. First the **background lighting** switches on. The display then shows the total active energy per tariff, the active energy per resettable memory RS1 or RS2, and the instantaneous values of consumption, voltage and current per phase.

Error message (false)

When the phase conductor is missing or the current direction is wrong 'false' and the corresponding phase conductor are indicated on the display.

Technical data page 16.

DSZ12DE-3x65A

without approval

EAN 4010312501221

198,20 €/pc.

DSZ12WDE-3x5 A



Typical connection

4-wire-connection 3x230/400V

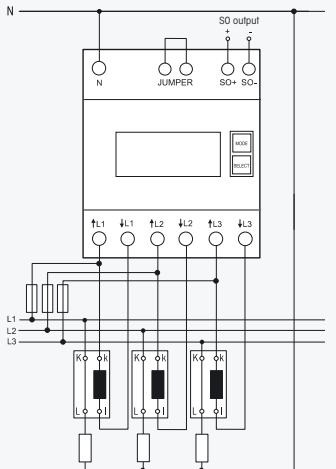

CT operated energy meter with settable CT ratio.

Maximum current 3x5A. Standby loss 0.4 watt per path only.

Modular device for DIN-EN 60715 TH35 rail mounting.

4 modules = 70mm wide and 58mm deep.

Accuracy class B (1%). With S0 interface.

This three-phase energy meter measures active energy by means of the current between input and output. The internal power consumption of 0.4 watt active power per path is neither metered nor indicated.

1, 2 or 3 phase conductors with max. currents up to 5A can be connected.

The inrush current is 10mA.

The N terminal must always be connected.

The 7 segment LC display is also legible twice within a period of 2 weeks without power supply.

Power consumption is shown by a bar flashing at a rate of 10 times per kWh.

On the right next to the display are the keys MODE and SELECT. Press them to scroll through the menu according to the operation manual. First the **background lighting** switches on. The display then shows the total active energy, the active energy per resettable memory, and the instantaneous values of consumption, voltage and current per phase.

The CT ratio can also be set. It is set to 5:5 at the factory and blocked with a bridge over the terminals which are marked with 'JUMPER'. To adjust the CT ratio to the installed transformer remove the bridge and reset the energy meter according to the operation manual. Then block it again with the bridge. Adjustable current transformer ratios: 5:5, 50:5, 100:5, 150:5, 200:5, 250:5, 300:5, 400:5, 500:5, 600:5, 750:5, 1000:5, 1250:5 and 1500:5.

Error message (false)

When the phase conductor is missing or the current direction is wrong 'false' and the corresponding phase conductor are indicated on the display.

Important! Before working on the current transformers disconnect the voltage paths of the energy meters.

Technical data page 16.

DSZ12WDE-3x5A

without approval

EAN 4010312501238

238,00 €/pc.

Recommended retail prices excluding VAT.

NEW

WSZ60

MID



Maximum current 60A, standby loss 1.2 watt.

Single-phase energy meter for 3-point energy meter mounting.

Accuracy class B.

This single-phase energy meter measures active energy by means of the current between input and output. The internal power consumption of 1.2 watt active power is neither metered nor indicated.

1 phase conductor with a max. current up to 60A can be connected. The inrush current is 10mA. The meter can be read anytime without power supply.

Power consumption is shown by a red LED flashing at a rate of 1000 times per kWh. Permanent light: halt; light off: free of tension.

Technical data page 17.

WSZ60

MID approval

EAN 4010312501368

50,30 €/pc.

NEW

DSZ60

MID



Maximum current 3x60A, standby loss 1 watt per path.

Three-phase energy meter for 3-point energy meter mounting.

Accuracy class B.

This directly measuring three-phase energy meter measures active energy by means of the current between input and output. The internal power consumption of 1 watt active power per path is neither metered nor indicated.

1, 2 or 3 phase conductors with max. currents up to 60A can be connected.

The inrush current is 10mA. The meter can be read anytime without power supply.

The N terminal must always be connected.

Power consumption is shown by a red LED flashing at a rate of 500 times per kWh. Permanent light: halt; light off: free of tension.

Technical data page 17.

DSZ60

MID approval

EAN 4010312501351

97,40 €/pc.

NEW

DSZ60D

MID



Maximum current 3x60A, standby loss 1 watt per path.

Three-phase energy meter for 3-point energy meter mounting.

Accuracy class B.

With additional terminals to switch over to a second tariff.

This directly measuring three-phase energy meter measures active energy by means of the current between input and output. The internal power consumption of 1 watt active power per path is neither metered nor indicated.

1, 2 or 3 phase conductors with max. currents up to 60A can be connected.

The inrush current is 10mA.

The N terminal must always be connected.

The 7 segment LC display is also legible without external power supply.

Power consumption is shown by a red LED flashing at a rate of 500 times per kWh. Permanent light: halt; light off: free of tension.

Technical data page 17.

DSZ60D

MID approval

EAN 4010312501344

119,30 €/pc.

Technical Data Single-phase and Three-phase Energy Meters and Energy Consumption Indicator

16

	EVA12-32 A WSZ12D-32A WSZ12DE-32 A WZR12-32 A	WSZ12D-65 A WSZ12DE-65 A	DSZ12D-3x65 A DSZ12DE-3x65 A	DSZ12WD-3x5A DSZ12WDE-3x5A
Rated voltage Extended range	230 V, 50 Hz -20 % / +15 %	230 V, 50 Hz -20 % / +15 %	3x230/400V, 50 Hz -20 % / +15 %	3x230/400V, 50 Hz -20 % / +15 %
Reference current I_{ref} (Limiting current I_{max})	5 (32) A	10 (65) A	3x10 (65) A	3x5 (6) A
Internal consumption Active power	0.5 W WSZ12D: 0.7 W	0.5 W WSZ12D: 0.7 W	0.4 W per path	0.4 W per path
Display	LC display 7 digits, therefrom 1 or 2 digits after the decimal point	LC display 7 digits, therefrom 1 or 2 digits after the decimal point	LC display 7 digits, therefrom 1 or 2 digits after the decimal point	LC display 7 digits, therefrom 1 digit after the decimal point
Display instantaneous values	WSZ12D: With a key you can select active power, voltage and current EVA12, WSZ12DE, WZR12: active power	WSZ12D: With a key you can select active power, voltage and current WSZ12DE: active power	With a key you can select total active power, active power resettable, tariff 1 and tariff 2 and power, voltage and current per phase	With a key you can select total active power, active power resettable and power, voltage and current per phase
Accuracy class $\pm 1\%$	B	B	B	B
Inrush current according to accuracy class B	20 mA	40 mA	40 mA	10 mA
Operating temperature	-10/+55°C	-10/+55°C	-10/+55°C	-10/+55°C
Interface (not EVA12, WZR12)	Pulse interface S0 according to DIN EN 62053-31, potential free by opto-coupler, max. 30V DC/20 mA and min. 5 V DC. Impedance 100 ohms			
	WSZ12D: pulse length 30 ms WSZ12DE: pulse length 50 ms	WSZ12D: pulse length 30 ms WSZ12DE: pulse length 50 ms	pulse length 30 ms	pulse length 30 ms
	2000 Imp./kWh	2000 Imp./kWh WSZ12DE-65 A: 1000 Imp./kWh	1000 Imp./kWh	10 Imp./kWh
Terminal cover sealable	With sealing cap PK18. For the current path 1 sealing cap is required	With sealing cap PK18. For the current path 1 sealing cap is required	Terminal cover claps	Terminal cover claps
Protection degree	IP50 for mounting in distribution cabins with protection class IP51			
Maximum conductor cross section	6 mm ² WSZ12D: L terminals 16 mm ²	L terminals 16 mm ² , N and S0 terminals 6 mm ²	N and L terminals 16 mm ² , S0 terminals 6 mm ²	

The N terminal of three-phase energy meters **must** be connected, if not the electronics might be destroyed.

	WSZ60	DSZ60	DSZ60D
Rated voltage Extended range	230 V, 50Hz -10% / +10%	3x230/400V, 50Hz -10% / +10%	3x230/400V, 50Hz -10% / +10%
Reference current I_{ref} (Limiting current I_{max})	5 (60) A	3x5 (60) A	
Internal consumption Active power	1.2 W	1 W per path	1 W per path
Display	drum type register with 7 digits and 1 decimal digit		LC display 7 digits, therefrom 1 decimal digit
Accuracy class $\pm 1\%$	B	B	B
Backstop	yes	yes	yes
Inrush current	10 mA	10 mA	10 mA
Number of tariffs	1	1	2
Operating temperature	-40/+70°C		-25/+70°C
Protection degree	IP51	IP51	IP51
Maximum conductor cross section	35 mm ²	35 mm ²	35 mm ²
weight	1.3 kg	1.7 kg	1.6 kg
dimensions	176x121x63 mm	270x178x60 mm	
EG model test certificate	DE-07-MI003-PTB 015	DE-08-MI003-PTB 013	

The Measuring Instruments Directive (MID) is a new European Union (EU) directive aimed at creating a single market for measuring instruments across the EU. It came into force on 30th October 2006. This regulation means that meters which receive a MID approval can be used in any other EU country irrespective of where in the EU that approval was granted. The meters can be used for billing purposes, industrial and commercial purposes.

Therefore, the MID replaces the present regulations consisting of national approval and subsequent calibration.

The MID covers a range of measuring instruments which include gas, water and active electrical energy meters. According to the directive all new types of meters must comply with the requirements of the directive as from 30 October 2006. However, all instruments approved before this date may continue to be marketed for up to 10 years.

For new types of measuring instruments the MID directive includes the following requirements:

- Compliance with standard DIN EN 50470-1-3
- Completion of conformity assessment
- Placing the product on the market
- Marking the devices in accordance with the directive
- Market surveillance

Validity of calibration, subsequent calibration and any charges will still be regulated by the national law.

When a MID device is put into circulation, we declare the conformity with MID in the operation instructions.

The number of the type examination certificate is also indicated there. It begins with the country code of the accredited laboratory, such as DE for Germany and CH for Switzerland.

The MID marking signifies the following:

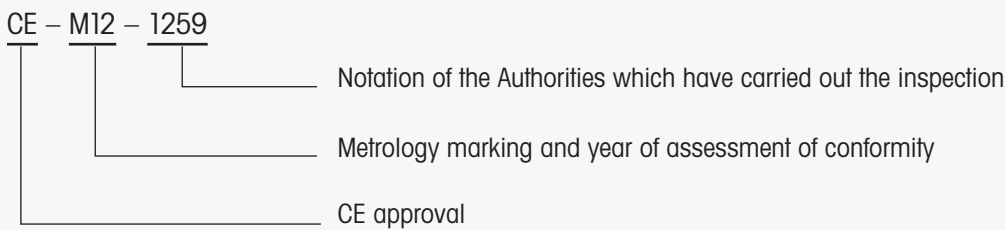

The year after the year of assessment of conformity is important for the follow-up calibration.

It will be renewed every year.

The duration of validity of the calibration is liable to national law.

Which accuracy classes exist?

The MID refers to new accuracy classes which are A, B, and C. These are in accordance with the familiar ones like 2, 1, and 0,5. The ELTAKO meters have accuracy class B (= former 1 with PTB).

Fellbach

Eltako Headquarter
Hofener Straße 54
70736 Fellbach
☎ 0711 94350000
☎ 0711 5183740
✉ info@eltako.de
✉ kundenservice@eltako.de

Baden-Württemberg

Carsten Krampe
75172 Pforzheim
☎ 0173 3180392
✉ krampe@eltako.de

Bavaria (North)

Horst Rock
91126 Schwabach
☎ 09122 61179
☎ 09122 61159
✉ rock@eltako.de

Bavaria (South)

Elka Hugo Kruschke GmbH
82024 Taufkirchen
☎ 089 3090409-0
☎ 089 3090409-50
✉ kruschke@eltako.de

Berlin/Brandenburg/ Saxony (East)

Olaf Knobel
15746 Groß-Köris
☎ 033766 21240
☎ 033766 21241
☎ 0176 13582503
✉ knobel@eltako.de

Hamburg/Schl.-Holstein/Bremen

Gunnar Wetteborn
25355 Barmstedt
☎ 0176 13582502
☎ 04123 6834673
✉ wetteborn@eltako.de

Hessen

Daniel Böth
63811 Stockstadt am Main
☎ 0173 3180391
✉ boeth@eltako.de

Technical support:

☎ +49 176 13582514 ✉ thuenta@eltako.de
☎ +49 711 94350002 ✉ technik-beratung1@eltako.de

Export Sales Manager:

☎ +49 711 94350005 ✉ export@eltako.de

Mecklenburg-Vorpommern/ Brandenburg (North)/ Saxony-Anhalt (North)

Klaus-Peter Schmitz
18276 Sarmstorf
☎ 03843 215884
☎ 03843 215884
☎ 0176 13582501
✉ schmitz@eltako.de

Lower Saxony

Detlef Hilker
31840 Hessisch Oldendorf/Barksen
☎ 05152 6984480
☎ 0173 3180390
✉ hilker@eltako.de

North Rhine-Westphalia (East)

Kay Westphal
44265 Dortmund
☎ 0176 13582506
☎ 0231 734171
✉ westphal@eltako.de

North Rhine-Westphalia (West)

Paul Frieg
46395 Bocholt
☎ 0176 13582507
☎ 02871 310988
✉ frieg@eltako.de

Rhineland-Palatinate/Saarland

Rainer Brilmayer
55411 Bingen
☎ 0176 13582516
✉ brilmayer@eltako.de

Thuringia/Saxony (West)/ Saxony-Anhalt (South)

Andreas Misch
39218 Schönebeck OT Elbenau
☎ 0176 13582505
✉ misch@eltako.de

Austria (West)

Representative Robert Goedicke
☎ +43 664 1823322
✉ goedicke@eltako.com

Austria (East)

Representative Andreas Kaider
☎ +43 699 11090025
✉ kaider@eltako.com

Belgium/France/ Luxembourg

Serelec n.v.
B-9000 Gent
☎ +32 9 2234953
✉ info@serelec-nv.be

Cyprus

MeshMade Ltd
CY 1096, Nicosia
☎ +357 7000 6374
✉ info@meshmade.com

Czech Republic

Representative Peter Loužecký
CZ-40011 Ústí nad Labem
☎ +420 475 621132
☎ +420 724 175676
✉ louzECKY@eltako.com

Denmark

SOLAR A/S
DK-6600 Vejle
☎ +45 76 961200
✉ jni@solar.dk

Gulf area

M/S Golden Sand Trading
U.A.E. – Dubai
☎ +9 71 43595611
✉ vasu2000@emirates.net.ae

Iceland

Reykjafell Ltd.
IS-125 Reykjavik Iceland
☎ +35 4 5886010
✉ reykjafell@reykjafell.is

Israel

Avital B.S. Ltd
Il-Holon
☎ +97 23 5587717
✉ avitalbs@zahav.net.il

Italy

Representative Tommaso Scrofani
I-64025 Pineto TE
☎ +39 085 9491796
☎ +39 347 3774888
✉ scrofani@eltako.com

Norway

Malfhe Winje Automasjon AS
NO-1415 Oppgaard
☎ +47 66996100
✉ firmapost@mwa.no

Netherlands (North)

Representative Hans Oving
NL-7701 WV Dedemsvaart
☎ +31 523 616688
☎ +31 6 21816115
✉ oving@eltako.com

Netherlands (South)

Representative Dennis Schellenberg
NL-5854 PC Bergen (LB)
☎ +31 6 50419067
✉ schellenberg@eltako.com

Portugal

TEV2 – Dist. Mat. Eléctrico, Lda
P-4470-434 Maia
☎ +351 229 478 170
✉ info@tev.pt

Russia

ATLAS Group JSC
RU-127591 Moscow
☎ +7 495 6423463
✉ eltako@atlasgroup.ru

Sweden (North/Middle)

Representative Patrick Savinainen
S-69332 Degerfors
☎ +46 070 9596906
✉ patrick@eltako.com

Sweden (West/East)

Representative Dan Koril
S-57010 Korsberga
☎ +46 070 3201102
✉ dan@eltako.com

Sweden (South)

Representative Jonas Lundquist
S-26433 Klippan
☎ +46 073 5815692
✉ jonas@eltako.com

Switzerland

Demelectric AG
CH-8954 Geroldswil
☎ +41 43 4554400
✉ info@demelectric.ch

Spain

Representative Thomas Klassmann
E-08397 PINEDA/Poble Nou
☎ +34 93 7692419
☎ +34 650 959702
✉ klassmann@eltako.com

South Africa

Innomatic (Pty) Ltd - Franz Markt
ZA-Midrand
☎ +27 11 8400840
✉ sales@innomatic.co.za



Eltako GmbH

Hofener Straße 54, D-70736 Fellbach

☎ +49 711 94350000 ☎ +49 711 5183740
✉ info@eltako.de 🌐 www.eltako.de